

a technical paper from **Bodine Electric Company**

## How to Wire a Permanent Split Capacitor (PSC) 3-Wire Reversible AC Motor or Gearmotor (115VAC/60Hz Models)

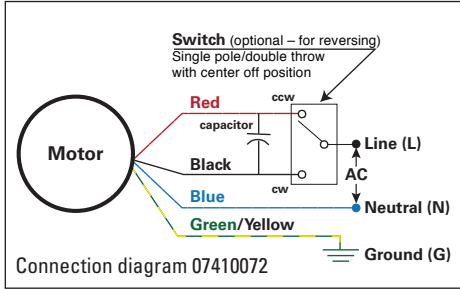

**PART 1: Wiring without a direction switch**  
Identify the wire colors and **confirm that the gearmotor or motor is a 3-wire reversible PSC model**. Bodine stock motors have red, black, and blue motor leads and a green-yellow ground lead.

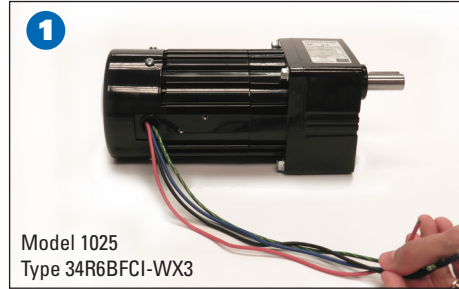

**Identify the capacitor value** to be used with the motor. The capacitor specifications are shown on the gearmotor/motor nameplate. The capacitor is not labeled with polarities, so the connection may be made to either wire.

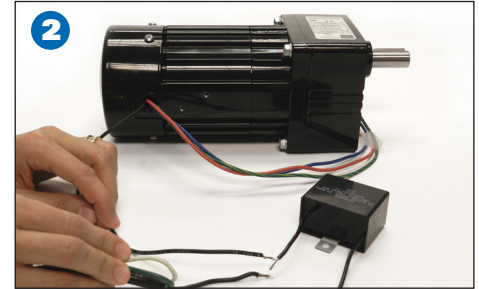

**To connect the motor to run clockwise: (see connection diagram 07410072)**  
Connect the black wire from the motor and the hot lead (L) from the AC line cord to one lead of the capacitor.

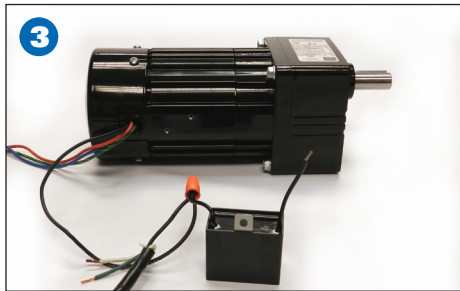

Since the wiring diagram does not specify AC line lead polarities, the connection may be made to either side of the AC line (i.e. hot or neutral) (**Figures 2 and 3**). However, when a switch is used it should interrupt the hot (L) line connection.

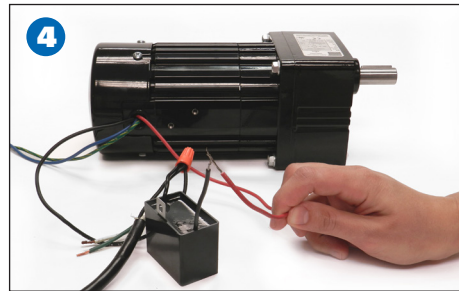

Connect the red wire from the motor to the other lead of the capacitor (**Figures 4 and 5**).

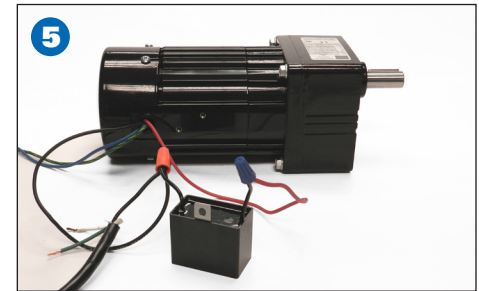

The capacitor must be permanently wired to the motor leads. Permanent split capacitor motors require a capacitor during start and while running.

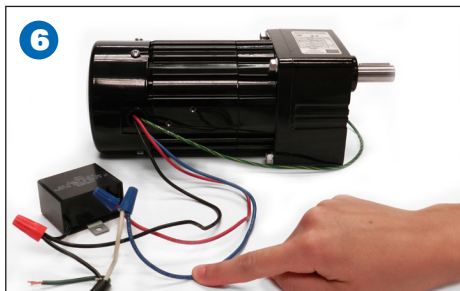

**Connect the other side of the AC line.**  
Connect the blue motor lead to the other lead of the AC line cord. Again, the connection may be made to either side (i.e. hot or neutral) (**Figure 6**).

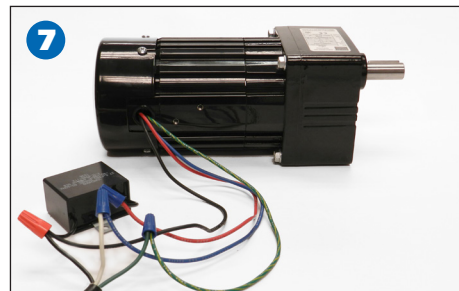

To complete wiring, connect the green-yellow ground lead to the ground wire in the AC line cord (**Figure 7**).

**To connect the motor to run counterclockwise: (see connection diagram 07410072)** Connect the **red** wire from the motor and the hot lead from the AC line cord to one lead of the capacitor. Since the wiring diagram does not specify AC line lead polarities, the connection may be made to either side of the AC line (i.e. hot or neutral). Connect the **black** wire from the motor to the other lead of the capacitor. The side of the AC line connected to the blue motor lead and the ground connection will remain unchanged.

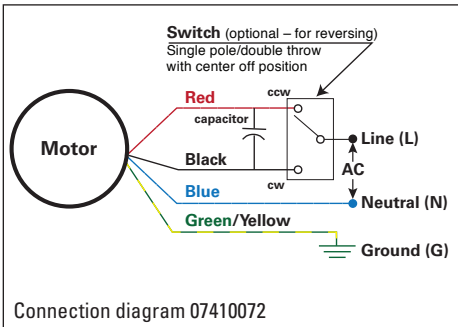

**PART 2: Wiring with a reversing switch (Wiring with a Single Pole, Double Throw Switch with Center-Off Position)**

*Optional switch: Carling single pole, double throw toggle switch, with center-off position, rated for 15A; part number 2FC53-73-TABS (purchased from DigiKey)*

Connection diagram 07410072 shows how to wire an optional switch to reverse the direction of the gearmotor. It uses a single pole, double throw switch, with a center-off position.

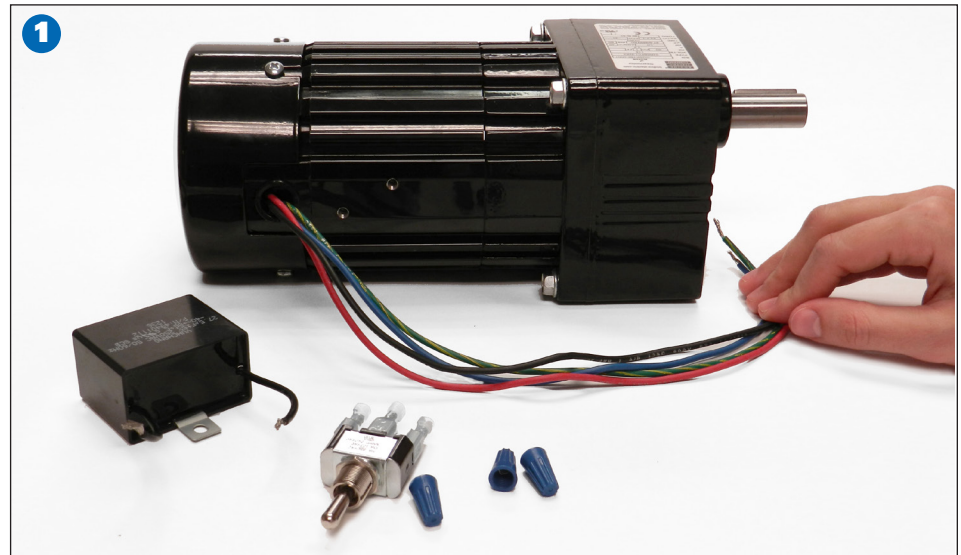

The purpose of the center-off position is to bring the motor to a complete stop before reversing its direction. Below are instructions on how to implement this diagram.

This guide uses a single pole, double throw switch with quick connect tab connectors, a model 1025 Bodine gearmotor, a model 49401112 capacitor, and an AC line cord (not shown in above picture) (Figure 1).

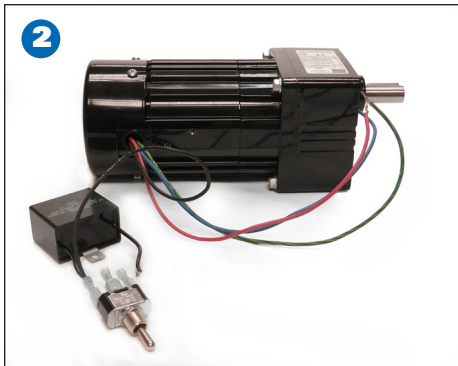

**Connect the black motor lead to one lead of the capacitor.** The capacitor is not labeled with polarities, so the connection may be made to either wire. **Next, connect to the "throw" end of the single pole, double throw switch.** The "throw ends" are normally the outer terminals of the switch (Figure 2).

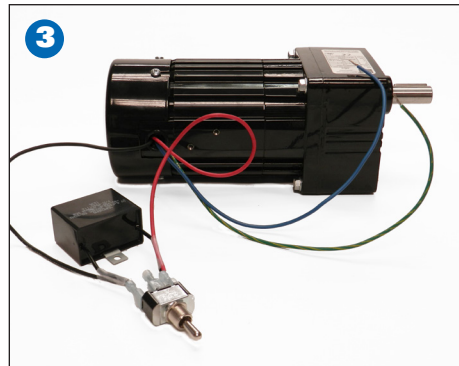

**Connect the red motor lead to the other lead of the capacitor. Next, connect to the other "throw" end of the switch (i.e. the other outer terminal) (Figure 3).**

**Connect one hot (L) side of the AC line to the "pole" terminal of the switch.** This is usually the middle terminal. While the wiring diagram does not specify AC line lead polarities, when no switch is used, the connection of the switch should be made to the hot AC Line (L) (not neutral) (Figure 4).

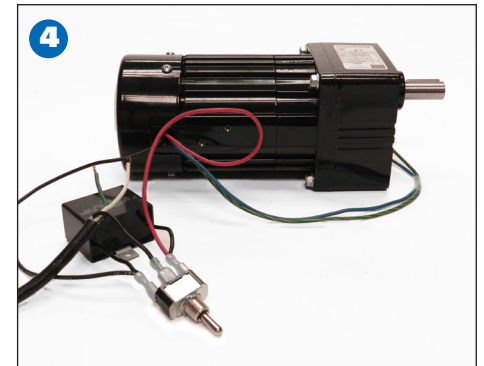

**Proceed to connect the blue motor lead to the other side of the AC line. To complete wiring, connect the motor's green-yellow ground lead to the ground on the AC line.**

Now the direction of the gearmotor/motor can be reversed with the single pole, double throw switch, with a center-off position.