

The background of the cover is a technical drawing of a motor assembly, showing various components like the stator, rotor, and housing with dimension lines and arrows. The drawing is rendered in white lines on a blue background.

FIFTH EDITION

BODINE

ELECTRIC

COMPANY

Handbook

Small
Gearmotors,
Motors,
and Controls

For up-to-date product information, 2D/3D CAD drawings and detailed specifications, please visit www.bodine-electric.com

About Us

Bodine Electric Company offers over 1,200 standard products, and thousands of custom designed fractional horsepower (<746 Watts) gearmotors, motors and motion controls (fixed and variable speed AC, brushless DC, and permanent magnet DC). Bodine products are available via an extensive distributor network or sold directly to OEMs.

Known for their reliability, long life and competitive prices, Bodine gearmotors and motors are designed for demanding industrial and commercial applications such as medical devices, scientific and laboratory equipment, labeling equipment, printing presses, packaging equipment, factory automation, and mobile and solar powered equipment. Bodine Electric is headquartered in Northfield, Illinois (20 miles north of Chicago) with manufacturing and assembly operations in Peosta, Iowa, U.S.A. Our quality management system is certified to ISO 9001.

Bodine Electric Company
201 Northfield Road
Northfield, Illinois 60093 U.S.A.

www.bodine-electric.com
info@bodine-electric.com

Phone: 773.478.3515



Copyright Notice: *Small Gearmotors, Motors, and Controls Handbook* ©2018 Bodine Electric Company. All rights reserved. Unauthorized duplication, distribution, or modification of this publication, in part or whole, is expressly prohibited. ISBN 9994675133.

Library of Congress Catalog Number 92-076079.

Contents

	Page
1 Electric Motor Fundamentals	
Basic Electricity	1-1
Basic Magnetism	1-6
Generators and Basic AC Circuits	1-12
Basic Mechanical Principles	1-20
2 AC Motors	
AC Motor Action	2-1
Polyphase (Two or More Phases) Motors	2-2
Single-Phase	2-5
Single-Phase AC Motor Types	2-5
Synchronous (Polyphase and Single-Phase)	2-12
3 Commutator (DC) Motors	
Brush-Type DC Motor Action	3-1
Brush-Type DC Motors	3-3
Brushless DC Motor Action	3-11
4 Special Purpose Motors	
Fractional Horsepower Gearmotors	4-1
Low Speed AC Synchronous Motors	4-2
Torque Motors	4-3
Switched Reluctance Motors	4-6
Linear Induction Motors	4-7
DC and AC Servo Motors	4-8
Shell-Type Armature Motor	4-9
Printed Circuit (PC) Motor	4-10
5 Basic Motor Construction	
Magnetic Materials and Motor Design	5-1
Bearings	5-6
Brushes	5-9
Insulation Systems	5-12
Environmental Protection	5-13
6 Gearhead Construction	
Gearing	6-1
Gear Trains	6-4
Gearmotor Lubrication	6-6
7 Motor/Gearmotor Selection and Application	
Motor and Gearmotor Industry Standards	7-1
Motor and Gearmotor Nameplate Ratings	7-3
Noise and Vibration	7-10
Thermal Protection	7-16
Energy Management	7-19
Load Torque Measurement	7-22
Motor Sizing	7-24
Application Guidelines	7-25
Safety	7-40
Care and Servicing	7-42

8 Motor Controls

Motion Control Systems	8-2
Motor Operating Characteristics	8-5
Motor Control Types	8-12
Passive Device Motor Controls	8-13
Solid State Electronic (Active) Motor Controls	8-21
Solid State Electronic (Active) Control of AC Motors	8-39
Motor Control Enclosure Standards	8-42

9 Feedback Devices

Tachometer Generators	9-2
Encoders	9-2

10 Clutches and Braking Techniques

Electromechanical Clutches and Brakes	10-1
Dynamic Braking	10-7
Evaluation of Dynamic Braking Methods	10-18

Appendix

1 List of Associations and Standards Organizations	A-1
2 Troubleshooting fhp Motors	A-2
3 Helpful Shortcuts	A-4
4 Motor Application Formulae	A-6
5 Properties of Materials	A-8
6 Temperature Conversions	A-9
7 SI (Metric) Conversion Table	A-10
8 Typical Gearmotor Construction	A-11
9 Horsepower/Watts vs. Torque Conversion Chart	A-12
10 Specific Resistance of Metals and Alloys at Ordinary Temperatures	A-17
11 NEMA Motor Frame Dimensions	A-18
12 International Voltage and Frequency Standards	A-19

Glossary	G-1
----------	-----

Connection Diagrams	CD-1
---------------------	------

Index	IN-1
-------	------

Final Review	FR-1
--------------	------

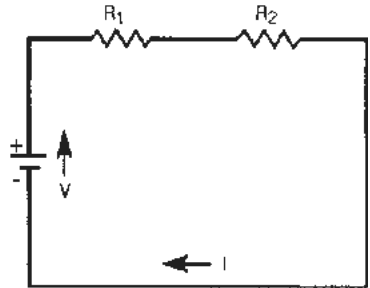
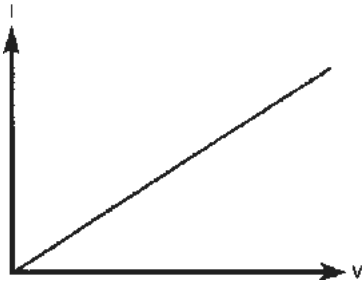

Electric Motor Fundamentals

Electric motors are designed to convert electrical energy into mechanical energy to perform some physical task or work. In order to understand the types of motors that are available as well as their performance characteristics, some understanding of the basic physical principles governing motor design and operation are required.

Basic electric motor design encompasses the laws of electricity and magnetism. Motor feedback and control systems involve semiconductor devices, microprocessors and other elements of electronics. And no discussion of motors would be complete without a brief understanding of the mechanical principles governing linear and angular motion.

This Chapter of the *Handbook* provides an overview of these fundamentals so that the reader will have a foundation on which to build a better understanding of motor design and performance specifications.

1.1 BASIC ELECTRICITY

Electric Current (I)

Atomic theory describes matter as an aggregate of atoms. Each atom consists of a nucleus containing positively charged protons and electrically neutral particles called neutrons. Revolving in orbits around the positive nucleus are negatively charged electrons.

In metallic conductors (such as copper), one or more electrons from the outer orbits become detached from each atom and move randomly from one atom to another. These are called free electrons. The positive nucleus and the rest of the electrons remain relatively fixed in position. Insulators, on the other hand, contain virtually no free electrons.

When an electric field is applied to a conductor, free electrons will drift under the influence of that electric field. Drifting electrons will collide with stationary atoms

causing additional free electrons to drift in the same direction. This movement of electric charge is called current.

The unit of measurement for current or rate of charge flow is the ampere. We speak of a direct current (DC) if the charges always flow in the same direction, even though the amount of charge flow per unit time may vary. If the flow of charge reverses its direction periodically, then we have what is called alternating current (AC). A more detailed description of direct and alternating current is presented in Section 1.3 of this Chapter.

Conventional Current Flow:

Before the acceptance of the electron theory, it was assumed that the direction of current flow was from a positively charged body to a negatively charged body. This positive to negative flow of current is called conventional current flow. However, in a metallic conductor, it is electrons that carry the charge from negative to positive. The flow of current from negative to positive is called electron flow. We will adopt conventional current flow throughout this Handbook. In the diagrams, the direction of current will always be from positive to negative.

Potential Difference (V)

Electrons will move between two points of a conductor if there is a potential difference (or a difference of “electric pressure”) between the two points. Voltage is the measure of the amount of pressure needed to push electrons through a conductor. It is analogous to a water pump that maintains a pressure difference between its inlet and outlet and results in water flow. Potential difference and voltage are often used interchangeably.

The unit of potential difference or voltage is the volt. A potential difference of one volt will be dropped across two points if a constant current of one ampere flowing

between the two points results in a power dissipation of one watt.

Resistance (R)

Resistance is defined as the opposition to current flow. Although electrons may flow in any substance, different materials offer different resistance to their flow.

Those which make the transfer of electrons relatively easy are called conductors (copper, aluminum, steel, etc.), and those which tend to impose substantial resistance are called insulators (wood, paper, mica, glass, etc.). Materials with a level of conductivity between these two extremes are called semiconductors (germanium, silicon). These “inbetween” materials have become increasingly useful in the application of electrical energy.

The unit of electrical resistance is the ohm (Ω). One ohm is defined as the resistance of a conductor which will allow a current flow of one ampere when a potential difference of one volt is applied. The resistance of a material is normally dependent on temperature. In general, the resistance of metallic conductors increases with temperature.

Ohm’s Law: Ohm’s law explains the relationship between voltage, current and resistance. It states that the amount of current through a conductor is directly proportional to voltage applied and inversely proportional to the resistance of the conductor or circuit:

$$I = \frac{V}{R}$$

A conductor obeys Ohm’s law when, for a given temperature, the current it conducts varies linearly with the applied voltage (Fig. 1-1).

Power: Electricity is used to perform some type of work or to generate heat. Power is the rate at which work is done or the rate at which heat is generated. The unit

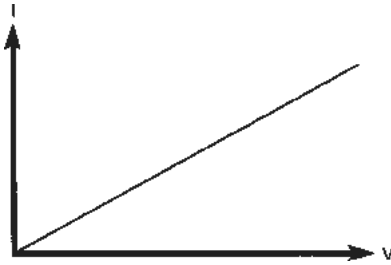

Fig. 1-1: Current varies linearly with applied voltage in accordance with Ohm's law.

for power is the watt. The amount of power dissipated is directly proportional to the amount of current flow and voltage applied:

$$P = VI$$

Power Loss: Power can also be expressed as a function of resistance and current. From Ohm's law we learned that $V = IR$. So if you substitute IR for V in the power formula you have:

$$P = (IR)I$$

$$\text{or } P = I^2R$$

The windings in an electric motor consist of many turns of copper wires. Although copper is an excellent conductor, the substantial total length of wire required in the windings results in measurable power loss because the resistance of a wire increases with its length. This I^2R loss in the motor is sometimes referred to as the copper loss.

Horsepower: Electric motors are rated in horsepower. One horsepower equals approximately 746 watts. Horsepower and watts are simply two different ways to express power.

Series Circuits: Figure 1-2 shows a simple series circuit with a voltage source and resistors R_1 and R_2 . A series circuit is one that allows only one path for

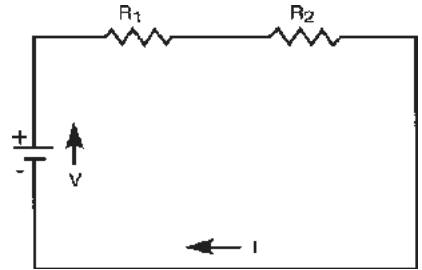

Fig. 1-2: Simplified series circuit.

current flow. There are three rules which govern series circuits.

- 1) The total circuit resistance is the sum of the individual resistances in the circuit:

$$R_T = R_1 + R_2 + \dots + R_N$$

- 2) Current has the same value at any point within a series circuit.

- 3) The sum of the individual voltages across resistors in a series circuit equals the applied voltage:

$$V = V_1 + V_2$$

Parallel Circuits: A simple parallel circuit is one that allows two or more paths for current flow. The resistors in Fig. 1-3 are said to be connected in parallel. There are also three rules which govern parallel circuits.

- 1) The voltage drop across each branch of a parallel circuit is the same as the applied voltage:

$$V = V_1 = V_2$$

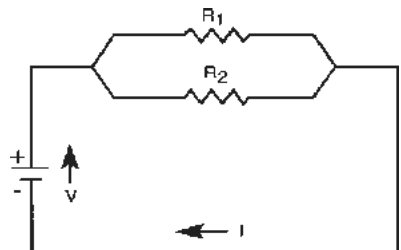

Fig. 1-3: Simplified parallel circuit.

- 2) The total current in a parallel circuit is equal to the sum of the branch currents:

$$I = I_1 + I_2$$

where I_1 and I_2 are currents flowing-part of through R_1 and R_2 respectively.

- 3) The total resistance in a parallel circuit is always less than or approximately equal to the value of the smallest resistance in any branch of the circuit.

Since $I = I_1 + I_2$ you can substitute $\frac{V}{R}$ in place of I and arrive at:

$$\frac{V}{R_T} = \frac{V_1}{R_1} + \frac{V_2}{R_2}$$

Since $V = V_1 = V_2$, you can substitute $V(\frac{1}{R_1} + \frac{1}{R_2})$ in the second part of the above equation leaving you with:

$$\frac{V}{R_T} = V(\frac{1}{R_1} + \frac{1}{R_2})$$

or

$$\frac{1}{R_T} = \frac{1}{R_1} + \frac{1}{R_2}$$

Therefore, the reciprocal of the total resistance is the sum of the reciprocal of the individual resistances. Solving for R results in:

$$R = \frac{1}{\frac{1}{R_1} + \frac{1}{R_2}}$$

In general, for N resistors in parallel, the equivalent resistance (R) is computed as follows:

$$\frac{1}{R} = \frac{1}{R_1} + \frac{1}{R_2} + \frac{1}{R_3} + \frac{1}{R_N}$$

Capacitance

A capacitor is a device that stores electric charge. Almost any insulated body can hold a limited electric charge, and the greater the surface area, the greater the charge that can be stored. In practical use, however, a capacitor is a compact system

of conductors and insulators (dielectric) so arranged that a large amount of electric charge can be stored in a relatively small volume.

The capacitance (C) is the measure of a capacitor's ability to store a charge on its plates at a given voltage (V):

$$C = \frac{Q}{V}$$

Q , measured in coulombs, is the charge stored in the capacitor. One coulomb has an equivalent charge of about 6.24×10^{18} electrons.

The unit of capacitance (C) is the farad (F). One farad is the capacitance of a capacitor in which a charge of one coulomb produces a change of one volt in potential difference between its plates.

One farad is an extremely large unit of capacitance. Based on the large physical size needed to produce such a component, smaller units of more convenient size such as the microfarad ($\mu F = 10^{-6}F$), and picofarad ($pF = 10^{-12}F$) are used in most applications.

A simple capacitor can be made by placing two identical metal plates in parallel with an air gap between them. See Fig. 1-4. It is known that the capacitance of a parallel plate capacitor increases proportionally with the area (A) of the plate and decreases proportionally with the distance (d) between them. We may thus write, $C = kA / d$, where k is a constant.

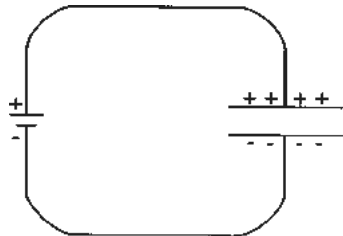

Fig. 1-4: Parallel plate capacitor.

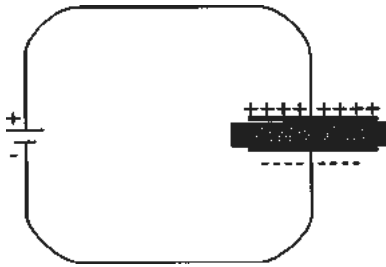

Fig. 1-5: Increased capacitance with dielectric.

It is also known that if a dielectric such as glass is placed between the plates (Fig. 1-5), the capacitance is increased five to ten times. In varying degrees, putting materials like mylar, mica, wax or mineral oil between the plates will all result in higher capacitance. Different insulating materials (dielectrics) offer different increases in capacitance. The ratio of the capacitance with the dielectric to that without the dielectric is called the dielectric constant (k) of the material. A vacuum has a dielectric constant: $k=1$.

Dielectrics used in commercial capacitors include air, oil, paper, wax, shellac, mica, glass, bakelite, polyester and oylpropylene film. Most capacitors are fabricated with strips of metal foil, as plates, separated by dielectric strips of the materials mentioned above. The foil and dielectric strips are sandwiched, rolled and encased into a compact form which is then fitted with terminals.

RC Circuit: The circuit shown in Fig. 1-5 consists only of a battery and a capacitor. Theoretically, with no resistance in the circuit, the capacitor would charge instantly. In reality however, when an electric potential is applied across an uncharged capacitor, the capacitor will not be charged instantaneously, but at a rate that is determined by both the capacitance and the resistance of the circuit. (The effect of inductance is neglected here. It will be discussed in Section 1.2 of (this Chapter).

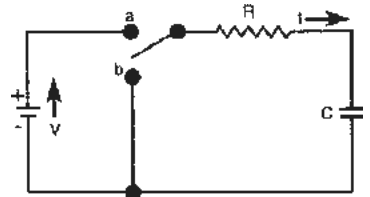

Fig. 1-6: Basic RC circuit.

Similarly, when a capacitor discharges it will not take place instantly. Rather, the discharge current will diminish exponential-ly over time.

Figure 1-6 illustrates a basic RC circuit. The capacitor will be charged if the switch is closed at the “a” position. If the switch is then closed at the “b” position, the capacitor will discharge.

With the resistor present in the circuit, current will not flow as freely. More time will be required to charge the capacitor. Likewise, it will take longer for the capacitor to discharge with the resistor in the circuit.

With a resistor in the circuit, the voltage across the capacitor rises more slowly. The current flow acts directly opposite. When the switch is first thrown to the “a” position there is more current flow. As the voltage across the capacitor reaches the battery potential, current flow decreases. When the capacitor voltage equals the battery voltage level, current flow stops.

Q is the amount of charge on the capacitor and is zero at time $t = 0$ (Fig. 1-7). Q will increase as the current flows until it reaches a maximum value ($Q = CV$), at which point the current is zero.

In DC circuits, capacitors oppose changes in voltage. The time delay for the capacitor’s voltage to reach the supply voltage is very useful because it can be controlled. It depends on two factors:

- 1) the resistance in the circuit, and
- 2) the size of the capacitor.

In Section 1.3, we shall see how a RC circuit functions when AC voltage is applied.

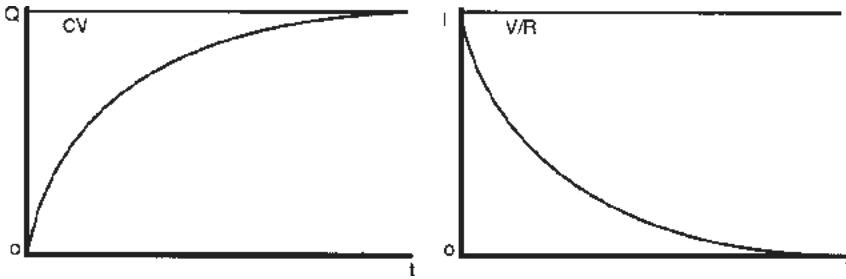

Fig. 1-7: Curves for Q and I during charging.

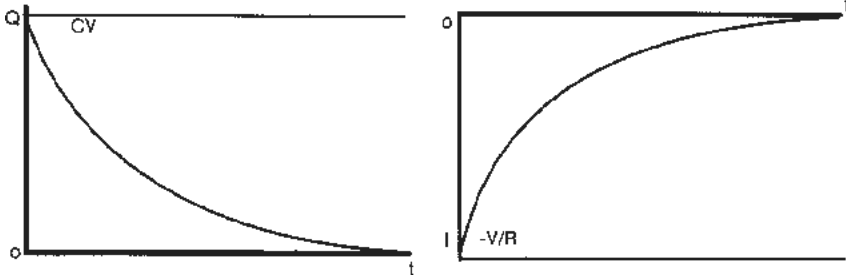

Fig. 1-8: Curves for Q and I during discharging.

Time Constant: The time it takes a capacitor to charge to 63% of the supply voltage is called the capacitive time constant (T). It can be calculated using the formula:

$$T = RC$$

A capacitor discharges in a similar manner as shown in Fig. 1-8. The current is now negative, because it flows in the opposite direction during discharging.

A capacitor is said to be fully charged or fully discharged after five RC time constants. The figures illustrate that current varies exponentially with time during the charging and discharging of an RC circuit when a DC source is applied.

1.2 BASIC MAGNETISM

Electric motors derive their characteristic ability to convert electrical energy to mechanical energy from magnetostatic force. Magnetostatic forces result from electric charges in motion. These charges

may flow freely through space, in a conductor, or exist as spinning electrons of the atoms that make up magnetic materials.

As early as 640 B.C. certain natural magnets were known to exist. Nearly 2000 years later, two simple laws governing their behavior were discovered:

- 1) Like poles repel each other, while unlike poles attract.
- 2) The force of attraction or repulsion is proportional to the inverse square of the distance between the poles.

Magnetic Field

An important property of magnets is that they can exert forces on one another without being in actual contact. This is explained by the existence of a magnetic field around a magnetized body. The magnetic field of the bar magnet (Fig. 1-9) is represented by the lines radiating out from the north pole and entering the south pole. Any other magnet placed in this magnetic field will experience a force. Forces will also be

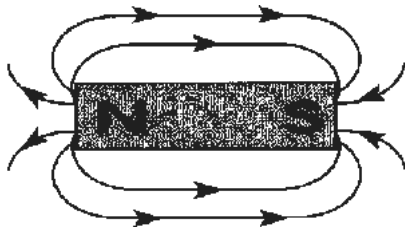

Fig. 1-9: Flux field pattern of a simple bar magnet.

exerted on electrons moving through a magnetic field.

Flux Density: The magnetic field lines in Fig. 1-9 are collectively referred to as the magnetic flux. Magnetic flux density is the amount of magnetic flux passing through a unit area plane at a right angle to the magnetic field. It is a measure of how concentrated the magnetic field is in a given area. Magnetic flux density (B) is a vector quantity. That is, it has magnitude as well as direction.

Magnetism at the Atomic Level

While ferrous materials, like iron, are strongly magnetic, many materials show at least some magnetic properties. Paramagnetic materials, mostly metals, exhibit very weak attraction to a magnet. The rest of the metals and nonmetals are diamagnetic—very weakly repelled by a magnet. Only the ferrous materials, some specialized alloys, and ceramics have sufficiently strong magnetic properties to be of commercial use.

No more than two electrons can share the same electron level or shell of an isolated atom. Diamagnetic materials have two electrons in each shell, spinning in opposite directions. See Fig. 1-10a. Since the magnetic response of a material is dependent upon the net magnetic moment of the atoms, this balanced symmetrical motion produces a magnetic “moment” of near

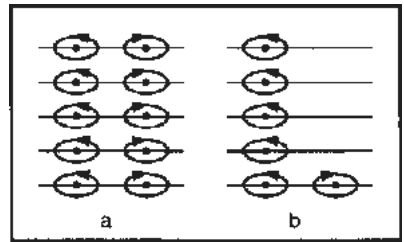

Fig 10: Arrangement of: a) electrons in diamagnetic materials (left), and b) electrons in magnetic materials (right).

zero. Quite simply, the fields produced by the counterspinning electrons cancel each other.

For the paramagnetic elements in which the electron shells are naturally asymmetric (Fig. 1-10b), each atom has a weak but significant magnetic field. However, few of the paramagnetic elements are magnetically very strong. These are called the ferromagnetic elements.

Ferromagnetism is the result of the asymmetrical arrangement of electrons in atoms in combination with a coupling or aligning of one atom’s magnetic field with that of an adjacent atom. This results in a strong magnetic response. This “exchange coupling” occurs only in materials in which the spacing between atoms falls within a certain range.

In iron, cobalt, nickel and gadolinium, the net magnetic moment is strong enough, and the atoms close enough, for spontaneous magnetic alignment of adjacent atoms to occur. Solid ferromagnetic materials conduct magnetic flux in the alignment direction.

Electric Current and Magnetic Fields

In 1820, Oersted discovered that an electric current passing through a conductor would establish a magnetic field. This discovery of the relationship between electricity and magnetism led to the development

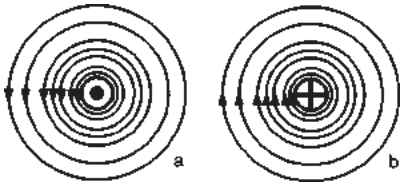

Fig. 1-11: Direction of flux flow with a) current flowing out of page (left), and b) flux flow with current flowing into page (right).

of most of our modern electric machines.

The magnetic field around a current-carrying straight conductor takes the form of concentric cylinders perpendicular to the conductor. In Fig. 1-11, the current is shown emerging from the page and the flux lines, shown as concentric circles, are flowing counterclockwise. When the direction of the current is reversed, the flux lines flow clockwise.

The right-hand rule, shown in Fig. 1-12, can be used to determine either the direction of the magnetic field or the direction of current when the other one is known.

When the current-carrying conductor is formed into a loop as shown in Fig. 1-13, the faces of the loop will show magnetic polarities. That is, all of the magnetic field lines enter the loop at one face and leave at the other, thus acting as a disc magnet. The polarities will be more pronounced and the magnetic field will be much stronger if we wind a number of loops into a solenoid (Fig. 1-14).

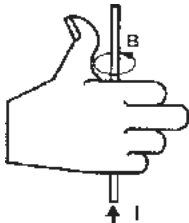

Fig. 1-12: Right-hand rule: thumb points in direction of current, palm curls in direction of magnetic field.

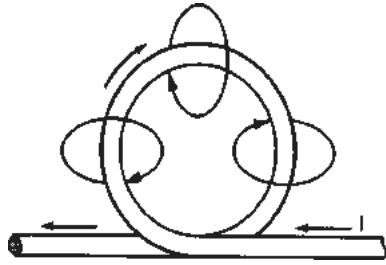

Fig. 1-13: Direction of magnetic flux when an energized conductor is formed into a loop.

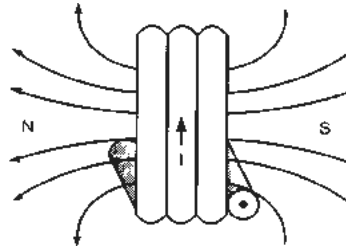

Fig. 1-14: Flux characteristics in simple solenoid.

The magnetic field developed by the solenoid resembles that of a bar magnet. The flux lines form continuous loops, leaving the solenoid at one end and returning at the other, thus establishing north and south poles.

The magnetic flux (Φ) of a given solenoid is directly proportional to the current (I) it carries. The same holds true for a straight conductor or a single loop of wire. For solenoids with different numbers of turns and currents, the magnetic flux is proportional to the product of the number of turns and the amount of current.

Properties of Magnetic Materials: When a ferromagnetic material, like an iron bar, is placed in a magnetic field, it presents a low resistance path to the flow of flux. This results in a “crowding effect,” as flux seeks to flow through it and flux density increases in the gaps at the ends of the bar. See Fig. 1-15. Iron, cobalt, nickel, some rare earth metals and a

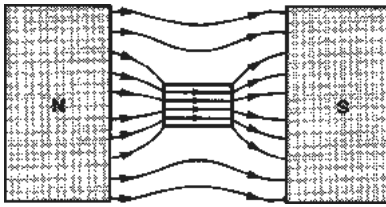

Fig. 1-15: Effect of an iron bar on a magnetic field.

variety of other ferromagnetic alloys and compounds are excellent magnetic conductors with high permeability.

Permeability and Magnetic Field Strength: Permeability (μ) is a measure of how well a material will conduct magnetic flux. It is related to magnetic flux density (B) and magnetic field strength (H) in the following equations:

$$B = \mu H$$

and $\mu = \mu_r \mu_0$

where $\mu_0 = 4\pi \times 10^{-7}$ (in SI units) and μ_r is the relative permeability with a value of unity (1) in free space.

The magnetic field strength (H) is measured in amperes per meter. The following formula shows that for a solenoid (conductor loop) with length (l) and a number of turns (N), the magnetic field strength within the solenoid is proportional to the current (I):

$$H = \frac{NI}{l}$$

For a given solenoid and current, H remains the same regardless of any material placed inside the solenoid. However, the magnetic flux density (B) will be directly proportional to the permeability (μ) of the material.

Magnetization, Demagnetization and Hysteresis: If a piece of iron is used as the core of a solenoid and the current is increased slowly (increasing the magnetic field strength, H), the

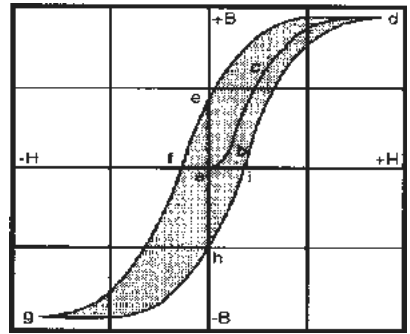

Fig. 1-16: Magnetization curve and hysteresis loop.

iron will be magnetized and follow the magnetization curve (abcd) as shown in Fig. 1-16.

The magnetization curve shows how the flux density (B) varies with the field strength (H). And since $B = \mu H$, it also shows how the permeability (μ) varies with the field strength. When H is gradually increased, the flux density (B) increases slowly at first (section ab of the curve). Then, as H is further increased, the curve rises steeply (bc of the curve). Finally, magnetic saturation is approached (near d) where the curve flattens out.

If the current is then gradually decreased, flux density (B) will decrease but the demagnetization curve will not retrace the path (dcba). Instead, it will follow a path de, where at point e, even though the current has been reduced to zero, there is some residual magnetism. If we then gradually increase the current in the reverse direction, creating $-H$, the iron will be completely demagnetized at point f. By further increasing the current and then slowly decreasing it, we will go through points g, h, i and d. The complete loop (defghi) is called a hysteresis loop and represents a virtual "fingerprint" for the material being used. See Fig. 1-16.

As iron is magnetized and demagnetized, work must be done to align and realign its atoms, and this work takes the

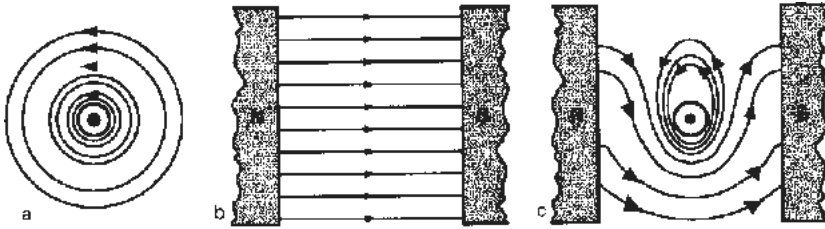

Fig. 1-17: a) Flux pattern around an energized conductor (left), b) flux between two magnetic poles (center), and c) effect of placing an energized conductor in a uniform magnetic field (right).

form of heat. In alternating current machines (i.e., motors and generators), the magnetizing and demagnetizing process takes place many times a second and hysteresis loss (heat) may be considerable, resulting in lower operating efficiency. The hysteresis loss for one cycle of alternating current is equal to the area enclosed by the hysteresis loop.

Motor Action: If we place a current-carrying conductor (Fig. 1-17a) between opposite magnetic poles (Fig. 1-17b), the flux lines below the conductor will move from left to right, while those above the conductor will travel in the opposite direction (Fig. 1-17c). The result is a strong magnetic field below the conductor and a weak field above, and the conductor will be pushed in an upward direction. This is the basic principle of electric motors and is sometimes called “motor action.”

The force (F) on the conductor is a product of the magnetic flux density (B), the conductor’s current(I) and the length of

the conductor(l):

$$F = BIl$$

where we have assumed that the conductor is at a right angle to the magnetic flux density (B).

An easy way to remember the direction of motion is to apply the right-hand rule, shown in Fig. 1-18.

Induced EMF

In general, if a conductor cuts across the flux lines of a magnetic field or vice versa, an emf is induced in the conductor. If the direction of the flux lines and the conductor are parallel, there is no induced emf.

Generator Action: If the conductor in Fig. 1-19 is moved vertically up or down in the magnetic field, an electromotive force is generated in the conductor. If the conductor is connected to a closed circuit, current will flow. This is the basic principle of electric generators and is also called “generator action.”

The induced emf is a product of the velocity of the motion (v), the magnetic flux density (B), and the length of the conductor (l):

$$emf = Blv$$

The relationship is valid only if the motion of the conductor is perpendicular to the flux lines.

The direction of induced emf depends on the direction of motion of the conductor and the direction of the magnetic field. This

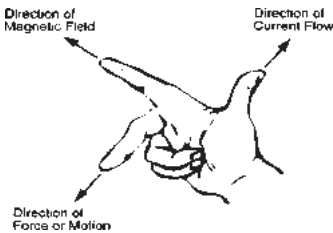

Fig. 1-18: Right-hand rule for force on a conductor in a magnetic field.

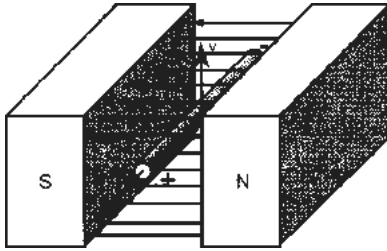

Fig. 1-19: Direction of induced emf in a conductor-cutting flux.

relationship can be shown by Fleming's left-hand rule for electromagnetism in Appendix 3.

Faraday's Law: We have seen that any conductor cutting across a magnetic field will produce an emf. However, this is only a special case of the more general law of induction established by Faraday in 1831: "If the total flux linking a circuit changes with time, there will be an induced emf in the circuit."

If we were to wind two coils around a steel bar, as in Fig. 1-20, connecting one to a battery with a simple on/off switch and the other to a sensitive galvanometer, the effect of closing the switch would produce a change in current and a change in the field thereby inducing a current in Coil 2. Similarly, if we were to open the circuit, a current would again register in Coil 2.

The induced emf in Coil 2 is mathematically related to the change of flux as follows:

$$emp = -N_2 \frac{d\phi}{dt}$$

Where N_2 is the number of turns in Coil 2 and $d\phi/dt$ is the rate of change of flux, the minus sign indicates that the induced current in Coil 2 will flow in such a way as to oppose the change of flux due to the change of current in Coil 1.

Since both coils are wound in the same direction, the induced current will flow in the direction shown in Fig. 1-20 when the switch is closed. This induced current in Coil 2 sets up a magnetic field opposes

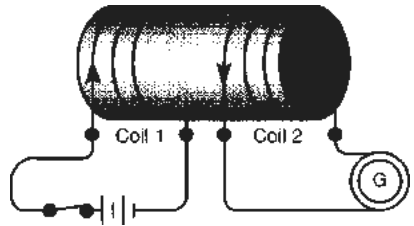

Fig. 1-20: Magnetically coupled coils wound around a steel bar.

the sudden increase of flux created by current flowing in Coil 1. If the switch is then opened, the current in Coil 2 will flow in the opposite direction creating a flux that opposes the sudden decline of flux from Coil 1.

Inductance (L)

The change of magnetic flux due to switching in Fig. 1-20 would also produce a counter emf (cemf) in Coil 1 itself. The cemf opposes the build-up or decline of current in the same circuit. The ability of a coil to store energy and oppose the build-up of current is called inductance.

For a given coil, the change of magnetic flux is proportional to the change of current. Thus, the cemf may be expressed as follows:

$$cemf = L \frac{di}{dt}$$

where L is called the inductance of the coil. A coil or circuit is said to have an inductance of one Henry when a current changing at the rate of one ampere/second induces one volt in it.

RL Circuit: In Section 1.1 we learned that there is a delay in the rise or fall of the current in an RC circuit. The RL circuit, shown in Fig. 1-21, has a similar property.

When the switch (S) is closed at a, the current in the resistor starts to rise. However, the cemf presented by the inductor (L) opposes the rise of the current, thus the resistor responds to the difference between

1.3 GENERATORS AND BASIC AC CIRCUITS

Electric motors are generally divided into DC and AC (induction) types. Each has its own operating characteristics and advantages. In this section, a brief review of direct current vs. alternating current will be presented followed by discussions of various AC circuits.

Direct Current: Direct current can be obtained through the chemical reactions in primary cells or secondary cells. Primary cells are batteries that consume their active materials when releasing electric energy and hence, are not reusable. Secondary cells (or storage cells), on the other hand, can be recharged by applying electricity in the reverse direction, thus reversing the chemical reaction.

Direct current is commonly produced by DC generators in which mechanical energy supplied by steam turbines, water wheels, water turbines or internal combustion engines is converted into electric energy. A brief description of a simple DC generator will be presented later.

In addition to the above, direct current can be generated from thermal energy (i.e., thermocouple) and light energy (solar cells). Furthermore, alternating current can be converted into direct current through the use of rectifiers.

Alternating Current: The most commonly supplied form of electric energy is alternating current. The main reason for the widespread use of AC is the fact that the voltage can be readily stepped up or down through the use of transformers. Voltage is stepped up for long distance transmissions and stepped down for sub-distribution. The voltage is stepped down even further for industrial and home use.

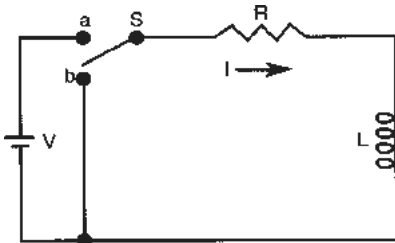

Fig. 1-21: Basic RL circuit.

the battery voltage(V) and the cemf of hte indicator. As a result, the current rises exponentially as shown in Fig. 1-22.

If we allow enough time for the current to reach V/R and then close the switch at b, current will continue to flow but diminish as the stored magnetic field energy is dissipated through the resistor. The current decay curve is similar to the capacitor charging curve in Fig. 1-7.

RL Time Constant: The time constant is the time at which the current in the circuit will rise to 63% of its final value (V/R) or decay to 37% of its initial value. It is represented by the formula:

$$\tau = \frac{L}{R}$$

The time constant can be controlled by varying the resistance or inductance of the circuit. Decreasing the circuit resistance increases the time constant. Increasing the inductance will also increase the time constant. Thus, the larger the time constant, the longer it takes the current to reach its final value. The current in an RL circuit will rise or fall to its final value after five time constants (within 99.3%).

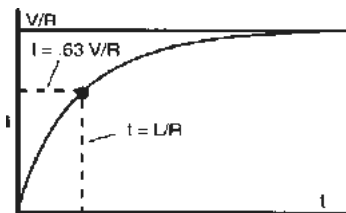

Fig. 1-22 Current rise in RL circuit.

For a given power (VI), stepping up the voltage decreases the current and consequently reduces the (I^2R) power loss in the power lines.

There are many additional advantages to AC. For example, AC is used to run induction motors (which do not require a direct supply of current to the rotating member and consequently avoid the problems associated with brush and commutator wear in DC motors). However, there are cases (battery charging, electroplating, etc.) where DC must be used. Motor applications in which adjustable speed control is important are generally operated from a DC source. However, in most of these cases, the energy is originally generated as AC and then rectified and converted to DC.

Alternating current can be supplied by generators (which will be discussed next) and by devices called inverters which convert DC into AC.

AC and DC Generators

Figure 1-23 shows a simple AC generator. In simple terms, a magnetic field or flux is established between the poles of a magnet. When a coil of conductive material is introduced into the air gap perpendicular to the flux and rotated mechanically at a uniform speed, it will cut the flux and induce an emf that causes a current to flow in the closed circuit formed by the slip

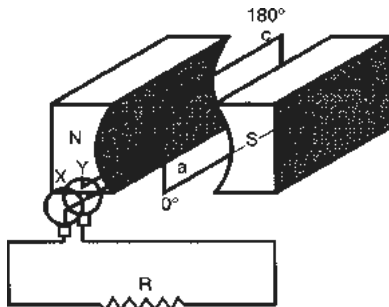

Fig. 1-23: Simple alternating current AC generator.

rings (X and Y), the brushes and the load resistor (R). With a full 360 degree revolution of the coil, the current flows first in one direction and then in the other, producing an alternating current.

If the coil in Fig. 1-23 were rotated counterclockwise at a constant speed, the top of the coil (cd) would cut the flux in a downward direction, while the bottom (ab) would cut the flux in an upward direction. By the right-hand rule of induction, the resulting current produced in the coil by reaction with the flux would flow from a to b and from c to d during the first 180 degrees of rotation.

As the coil continued around to its original position, ab would cut the flux downward and cd upward, causing an opposite current flow from d to c and b to a. One 360 degree rotation of the coil is equivalent to one cycle. Since standard available current is 60 Hz (cycles per second), the coil would be rotated sixty full rotations per second to deliver standard 60 Hz AC. This back and forth flow of current can be represented graphically as a sine wave in Fig. 1-24.

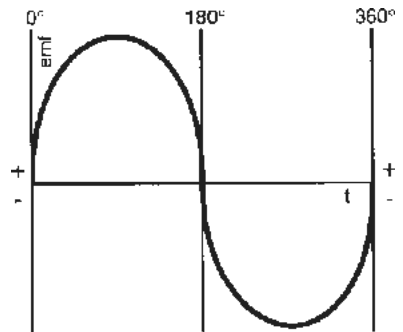

Fig. 1-24: Sine wave characteristic of AC current during one cycle (360°).

Without going into the mathematical details, the wave shape of the induced emf can be explained by the fact that the rate of change of flux (Ω) through the surface a-b-c-d formed by the wire loop is a sinusoidal

function of time. Since by Faraday's law (see Section 1.2) the induced emf is proportional to the rate of change of flux, a sinusoidal induced emf results.

For DC generators, the same principle of flux cutting holds true, except that instead of the slip rings, a synchronous mechanical switching device called a commutator is used. See Fig. 1-25.

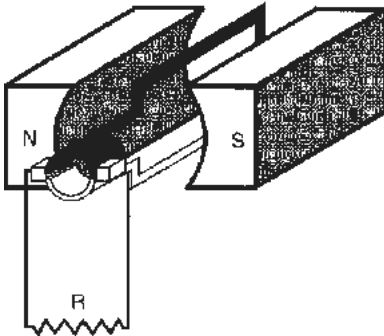

Fig. 1-25: Simple DC generator.

The arrangement of commutator and brushes allows the connections to the external circuit (in our case, the resistor, R) to be interchanged at the instant when the emf in the coil reverses, thus maintaining a uni-directional (although pulsating) current (see Fig. 1-26).

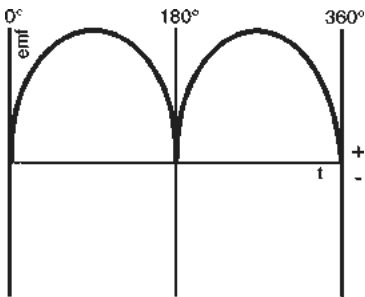

Fig. 1-26: Induced emf from the simple DC generator.

The pulsating emf from the simple DC generator is not very useful when relatively uniform DC voltage is required. In practice, a DC generator has a large number of coils and a commutator with many

segments. Each coil is connected to its own pair of commutator segments. The brushes make contact with each coil for a short period of time when the emf in that coil is near its maximum value. Figure 1-27 illustrates the emf output of a DC generator with four evenly spaced coils connected to an eight-segment commutator. The dotted curves are the induced emfs (eight emfs for every revolution). The solid line is the output voltage of the generator.

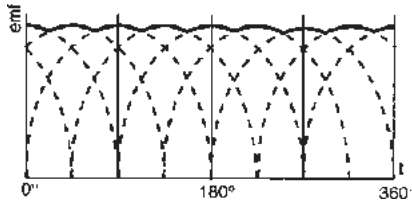

Fig. 1-27: Output of DC generator with four coils and an eight-segment commutator.

Two-Phase and Three-Phase AC:

In addition to single-phase AC produced by the generator described above, alternating current may be supplied as both two and three-phase. Using the example of the simple single coil AC generator described before, if we were to add a second coil with its loop arranged perpendicular to the original (see Fig. 1-28) and rotate them mechanically with a uni-

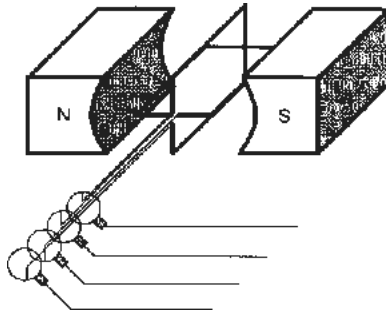

Fig. 1-28: Simple two-phase AC generator.

form speed, two-phase voltage would be produced.

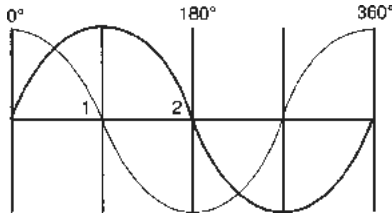

Fig. 1-29: Wave shapes produced by two-phase AC.

The resulting two-phase voltage sequence is shown in Fig. 1-29, where one phase lags the other phase by 90 degrees.

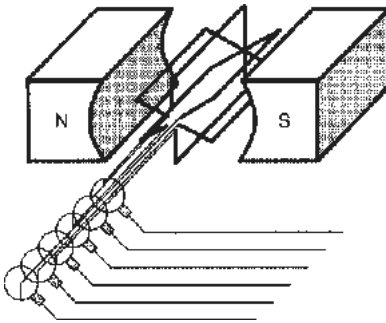

Fig. 1-30: Simple three-phase AC generator.

If we were to add one more coil and space the three at 120 degrees to each other (see Fig. 1-30), the same generator would now produce three-phase current (Fig. 1-31).

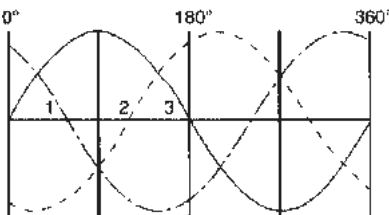

Fig. 1-31: Wave shapes produced by three-phase AC.

Two and three-phase current are used in both polyphase and induction motor design. Since both will produce a rotating

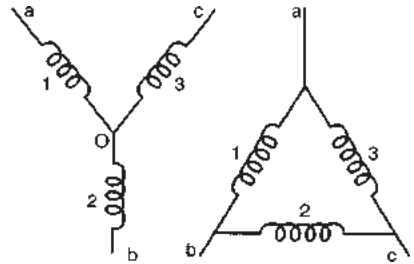

Fig. 1-32: Delta-connection of three coils (right), Wye-connection of three coils (left).

produce a rotating magnetic field in the stator bore, the rotor will follow the field and result in rotation. This principle will be discussed further in Chapter 2.

The Delta (Δ)-Connection and Wye-Connection: Although it is shown in Fig. 1-30 that each coil of the three-phase AC generator is provided with its own pair of slip rings and brushes, the practical design of a three-phase generator has only three slip rings and brushes. This is accomplished by either the Delta-connection or Wye-connection of the three coils (1, 2, and 3) in the generator.

Figure 1-32 shows a Delta-connection with output terminals (a, b and c). The three pairs of terminals (a-b, b-c, and c-a) provide a three-phase output like the one shown in Fig. 1-31. The line voltage (voltage from any pair of the terminals) is the same as the coil voltage (voltage across each coil). The line current, however, is $\sqrt{3}$ times the coil current.

The Wye-connection shown in Fig. 1-32 again has terminals a, b, and c. There is also a common point called the neutral in the middle (O). Again, the terminal pairs (a-b, b-c, and c-a) provide a three-phase supply. In this connection, the line voltage is $\sqrt{3}$ times the coil voltage while the line current is the same as the coil current. The neutral point may be grounded. It can be brought out to the power user via a four-

wire power system for a dual voltage supply.

For example, in a 120/208-volt system, a power user can obtain 208 volt, three-phase output by using the three wires from a, b, and c. Furthermore, single-phase, 120 volt power can be tapped from either O-a, O-b or O-c.

AC Circuits

While many forms of “alternating current” are nonsinusoidal, the popular use of the term alternating current, or AC, usually implies sinusoidal voltage or current. Electro-magnetic devices such as motors consist of ferromagnetic materials with nonlinear voltage/current relationships. Thus, current will not be pure sinusoidal.

Root-Mean-Square or Effective Values, and Power Factor in AC Circuits:

The voltage (V) and current (I) in a sinusoidal alternating current circuit consisting of linear devices are generally written as:

$$V = V_m \sin(2\pi ft)$$

$$I = I_m \sin(2\pi ft - \phi)$$

Here, V_m and I_m are the peak values of V and I respectively, f is the frequency in hertz (Hz) and ϕ is the phase angle (in radians) between the current and the applied voltage. (See Fig. 1-33). Since the positive portion of the voltage or current is the mirror image of the negative portion, the

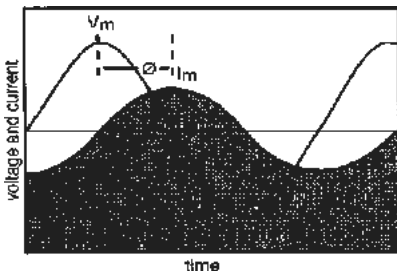

Fig. 1-33: V_m and I_m are out of phase by an angle ϕ .

average value in one complete cycle is zero.

This result provides no useful information about the magnitude. One useful way of specifying the magnitude of the AC is to compute its root-mean-square (rms) value which is alternatively called the effective value.

The effective value of alternating current is that which will produce the same amount of heat or power in a resistance as the corresponding value of direct current. The effective value of current (I) is obtained by first computing the average of the square of the current and then taking the square root of the result. Without performing the computation, we will just state that the effective value of current I_e is:

$$I_e = \frac{I_m}{\sqrt{2}} = 0.707 I_m$$

Similarly, the effective voltage (V_e) is:

$$V_e = \frac{V_m}{\sqrt{2}} = 0.707 V_m$$

Then the average power (\bar{P}) of the circuit can be shown to be:

$$\bar{P} = I_e V_e \cos \phi$$

The quantity ($\cos \phi$) is called the power factor of the circuit. If the current (I) and voltage (V) are in phase (i.e., $\phi = 0$) then we have the maximum power ($P = I_e V_e$). Stated another way, only the component of I_e in phase with V_e contributes to the average power. The other component may be said to be “wattless.”

Pure Resistance AC Circuit

A pure resistance circuit is one in which there is no significant inductive or capacitive component. In such a circuit, the current and voltage would both be sinusoidal and in phase ($\phi = 0$). See Fig. 1-34. Pure resistance circuits can be treated as if they

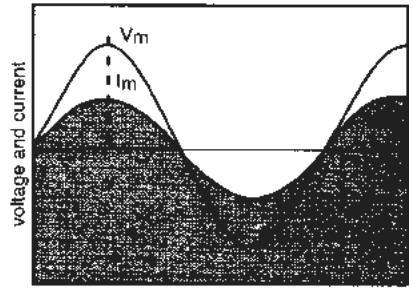
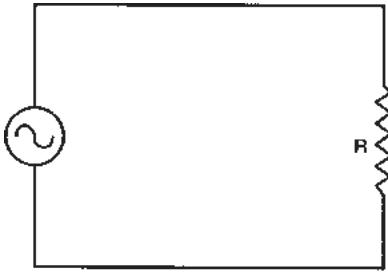

Fig. 1-34: Pure resistance (R) circuit. V_m and I_m are in phase, $\phi = 0^\circ$.

were DC circuits if the effective values of current and voltage (I_e and V_e) are used:

$$I_e = \frac{V_e}{R}$$

Since the average power:

$$\overline{P} = I_e V_e \cos \phi$$

then for the phase angle $\phi = 0^\circ$:

$$\overline{P} = I_e V_e = I_e^2 R$$

$$\text{or } \overline{P} = \frac{V_e^2}{R}$$

Pure Inductance AC Circuit

In an inductive circuit, the counter emf (or self-inductance) of the inductor will offer opposition to any change in the current. Since an alternating current is one that is continually changing, there will be a continual opposition to the flow of current corresponding in value to the rate of change of current.

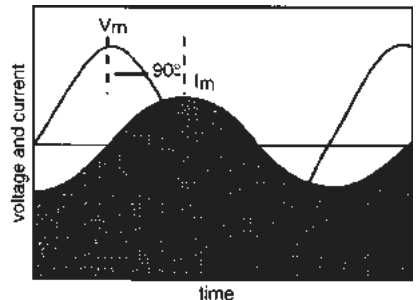
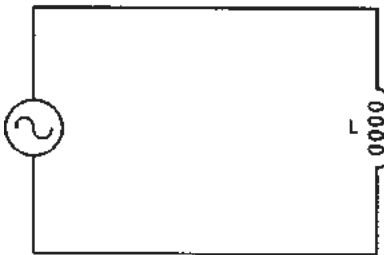

Fig. 1-35: Pure inductance (L) circuit. I lags V , $\phi = 90^\circ$.

Inductive Reactance: The opposition to the current flow in an inductance circuit is called the inductive reactance (X_L), which is given by the formula:

$$X_L = 2\pi f L$$

where X_L is in ohms, f is the frequency in Hz and L is the inductance in Henrys.

The phase angle (ϕ) is $+90^\circ$. Thus, a pure inductance circuit will not only offer opposition to current flow but will also cause the current to lag behind the voltage by 90° (Fig. 1-35).

The effective current (I_e) and average power (P) are:

$$I_e = \frac{V_e}{X_L}$$

$$\overline{P} = I_e V_e \cos \phi$$

$$\text{since } \phi = 90^\circ, \cos \phi$$

$$\text{then } \overline{P} = 0$$

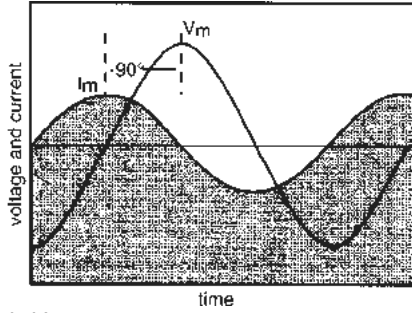
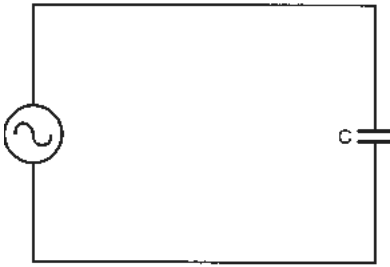

Fig. 1-36: Pure capacitance (C) circuit. I leads V . $\phi = -90^\circ$.

Therefore, there is no power loss in a pure inductance circuit.

Pure Capacitance AC Circuit

A capacitor placed in a circuit also presents opposition to current flow. This is due to the limitation that charge will flow into the capacitor and accumulate only to the level proportional to the applied voltage. No further charge will flow in or out until there is a corresponding change in applied voltage.

Thus, the current in a capacitor circuit is proportional to the slope of the voltage curve. The slope is highest for a sinusoid when $V = 0$ and the current flow is at its maximum. The slope is zero when V is at its peak (positive or negative) and this corresponds to a zero current flow.

Capacitive Reactance: The opposition to current flow in a capacitance

circuit is called the capacitive reactance (X_c). Its value is given by the formula:

$$X_c = \frac{1}{2\pi fC}$$

where X_c is in ohms, f is the frequency in Hz and C is the capacitance in Farads.

The phase angle (ϕ) in this circuit is -90° . Thus, in a pure capacitance circuit, the current leads the voltage by 90° (Fig. 1-36).

The effective current (I_c) is:

$$I_c = \frac{V_c}{X_c}$$

Since $\phi = -90^\circ$, $\cos \phi = 0$. There is also no power loss in a pure capacitance circuit.

RL AC Circuit

When R and L are connected in series in an AC circuit, we have the series RL circuit shown in Fig. 1-37. Both the resistance (R) and the inductive reactance (X_L)

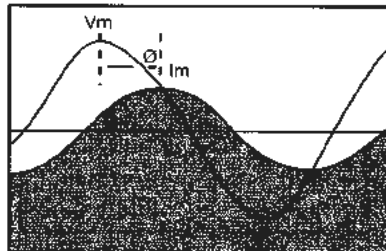
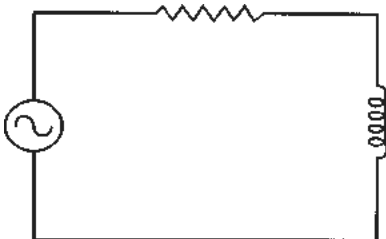

Fig. 1-37: Series RL circuit. I lags V . $0 < \phi < 90^\circ$.

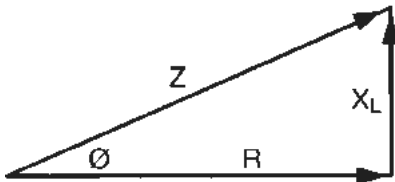

Fig. 1-38: Impedance diagram of an RL circuit.

of the inductor offer opposition to current flow.

Impedance in RL Circuit: The combined effect of R and X_L is called the impedance (Z) which is expressed in ohms:

$$Z = \sqrt{R^2 + X_L^2}$$

The impedance can be represented as the hypotenuse of a right angle triangle whose sides are R and X_L (Fig. 1-38). This is also referred to as the impedance diagram.

The phase angle (ϕ) in this circuit happens to be the angle between Z and R (or, $\cos \phi = R/Z$). Since ϕ is between 0° and 90° , the current (I) in the circuit lags behind the voltage by an angle between 0° to 90° depending on the values of R and X_L .

The effective current (I_e) and average power (P) are:

$$I_e = \frac{V_e}{Z} = \frac{V_e}{\sqrt{R^2 + X_L^2}}$$

$$\overline{P} = I_e V_e \cos \phi$$

where

$$\cos \phi = \frac{R}{Z}$$

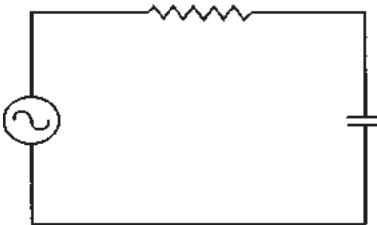

Fig. 1-39: RC circuit. I leads V. $-90^\circ < \phi < 0$.

Since no power is lost in the inductance, then:

$$\overline{P} = I_e^2 R$$

RC AC Circuit

Similar to the RL circuit described previously, resistance (R) and capacitive reactance (X_C) will both oppose current flow in an AC circuit. Unlike the RL circuit, increasing C or the frequency results in a decrease in X_C and an increase in current. See Fig. 1-39.

Impedance in RC Circuit:

The impedance (Z) in this case is:

$$Z = \sqrt{R^2 + X_C^2}$$

The vectorial representation is shown in Fig. 1-40, where X_C is pointing downwards and represents a "negative" Vector.

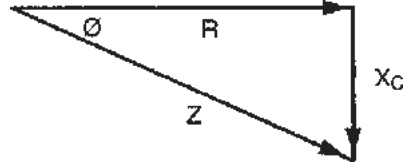
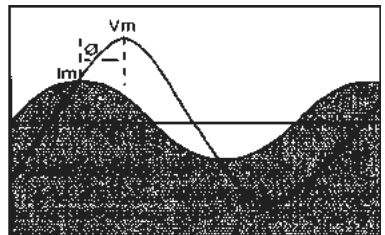

Fig. 1-40: Impedance diagram of an RC circuit.

The phase angle (ϕ) is now between -90° and 0° , and:

$$\cos \phi = \frac{R}{Z}$$

The current (I) in the circuit lags the voltage by an angle (ϕ) between 0° and 90° depending on the values of R and X_C . Refer to Fig. 1-39.



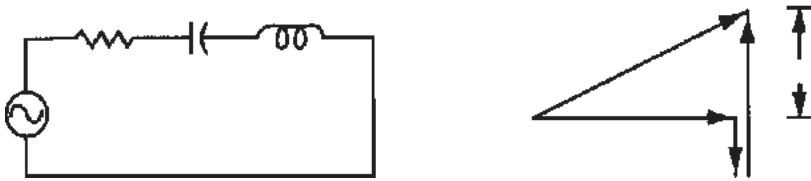

Fig. 1-41: Basic RLC circuit (left) and vector diagram (right).

The effective current (I_e) is:

$$I_e = \frac{V_e}{Z} = \frac{V_e}{\sqrt{R^2 + X_C^2}}$$

where

$$\cos \phi = \frac{R}{Z}$$

Since no power is lost in the capacitance:

$$\overline{P} = I_e^2 R$$

RLC AC Circuit

To further generalize the AC series circuit, we should consider the RLC circuit shown in Fig. 1-41. The impedance of this circuit is:

$$Z = \sqrt{R^2 + (X_L - X_C)^2}$$

The vector diagram of the above relationship is also shown in Fig. 1-41. The phase angle (ϕ) in an RLC circuit is between -90° and $+90^\circ$ where:

$$\cos \phi = \frac{R}{Z}$$

If $X_L > X_C$, then the current in the circuit will be lagging the voltage. If $X_L < X_C$, then the current will be leading the voltage. If $X_L = X_C$, the circuit is said to be resonant and will behave as purely resistive.

The effective current (I_e) is:

$$I_e = \frac{V_e}{Z} = \frac{V_e}{\sqrt{R^2 + (X_L - X_C)^2}}$$

and

$$\overline{P} = I_e V_e \cos \phi = I_e^2 R$$

Basic DC circuits involving resistance (R), inductance (L), and capacitance (C)

have been presented in Sections 1.1 and 1.2. In this Chapter, we have also seen how these same elements (R, L and C) work in AC circuits. Understanding these basic circuits is important, since an induction motor driven by AC power is a system of resistance, inductance and capacitance.

1.4 BASIC MECHANICAL PRINCIPLES

Until now, we have presented the electrical characteristics of motors to acquaint you with the fundamentals of motor action and the effects of direct and alternating current on motor design and operation. Electrical characteristics affect a designer's decisions on which motor to choose for any given application.

Equally important in understanding motor operation are the mechanics and performance characteristics of electric motors. Mechanics encompasses the rules which govern the motion of objects, in particular:

- a) the force which must be applied to start an object moving or to stop it, and
- b) the opposing forces which must be overcome before movement can begin or end.

Other factors such as speed, acceleration and amount of displacement all play a part in determining which motor is best suited to perform a task. This section is intended to provide general information on mechanics. Throughout this *Handbook*, other, more specific formulas will be given as they apply to a particular type of motor

or application. Other mechanical data and mathematical formulas can be found in the Appendix Section of the *Handbook*.

Translational Motion

The movement of a uniform object in a straight line is referred to as translational motion. The three parameters of translational motion are displacement, velocity and acceleration.

Displacement: The change in position of an object is known as displacement. It is a vector quantity with both magnitude and direction and is shown mathematically as:

$$\Delta x = x_f - x_i$$

where Δx is the total displacement, x_f is the object's final position and x_i is the object's initial position.

Velocity: The rate at which an object's position changes with time is its velocity. There are two types of velocity: average and instantaneous. Average velocity is the net displacement divided by the elapsed time:

$$v = \frac{\Delta x}{\Delta t} = \frac{x_f - x_i}{t_f - t_i}$$

where Δx is the net displacement and t is the elapsed time to make the displacement, t_f is the final time and t_i is the initial time.

At any instant in time the velocity of an object may exceed the average velocity, so it is sometimes necessary to know the instantaneous velocity:

$$v = \lim_{\Delta t \rightarrow 0} \frac{\Delta x}{\Delta t} = \frac{dx}{dt}$$

Speed: Frequently, the terms speed and velocity are used interchangeably. Velocity can be positive or negative. Speed is equal to the absolute value of the instantaneous velocity and is always expressed as a positive number:

$$s = |v|$$

Acceleration: As an object begins to move, its velocity changes with respect to time. This is called acceleration. Like velocity, acceleration is expressed in average and instantaneous quantities. Average acceleration equals:

$$a = \frac{\Delta v}{\Delta t} = \frac{v_f - v_i}{t_f - t_i}$$

where Δv is the difference between the object's final and initial velocities, and Δt is the elapsed time.

The instantaneous acceleration is defined by the following formula:

$$a = \lim_{\Delta t \rightarrow 0} \frac{\Delta v}{\Delta t} = \frac{dv}{dt}$$

Rotational Motion

Motors can be used to move objects in a straight line, which is why a brief overview of translational motion was given. But motor design and application focuses heavily on rotational motion around an axis. The same principles of displacement, velocity and acceleration also govern rotational motion. In many motion control applications, it often becomes necessary to transform linear motion into rotational motion or vice versa.

Angular Displacement: For rotational motion, displacement is expressed in radians, degrees or revolutions because the displacement occurs in reference to a rotational axis (one radian = 57.3° , one revolution = $360^\circ = 2\pi$ radians.) Angular displacement is expressed as:

$$\Delta\theta = \theta_2 - \theta_1$$

where θ_1 is the object's initial angular position relative to the axis and θ_2 is the final angular position.

Angular Velocity: Angular velocity is expressed in radians / second, revolutions / second, or revolutions / minute (RPM). It is the rate at which an object's angular displacement changes with

respect to time. Like translational velocity, it can be expressed as an average or instantaneous quantity.

The formula for average angular velocity is:

$$\omega = \frac{\Delta\theta}{\Delta t} = \frac{\theta_2 - \theta_1}{t_2 - t_1}$$

where $\Delta\theta$ is the net angular displacement between the initial position and final position and Δt is the elapsed time.

Instantaneous angular velocity is expressed as follows:

$$\omega = \lim_{\Delta t \rightarrow 0} \frac{\Delta\theta}{\Delta t} = \frac{d\theta}{dt} = \frac{v}{r}$$

where v = circumferential linear velocity.

Angular Acceleration: When an object's angular velocity changes with respect to time, it is undergoing angular acceleration. Average angular acceleration is expressed as:

$$a = \frac{\Delta\omega}{\Delta t} = \frac{\omega_f - \omega_i}{t_f - t_i}$$

An object's instantaneous angular acceleration can be calculated as:

$$a = \lim_{\Delta t \rightarrow 0} \frac{\Delta\omega}{\Delta t} = \frac{d\omega}{dt}$$

Statics and Dynamics

The previous discussion focused on the motion of an object either in a straight line or about an axis. But other factors must be considered when discussing motion. The size and weight of an object determine the amount of force needed to move it or stop it. Other factors such as friction also play a role in determining the amount of force needed to move an object. We will now center our attention on these other factors.

Mass: Mass is the property of an object that determines its resistance to motion. It is a factor of the object's weight (W) and its acceleration due to gravity (g). Mass is the quantitative measure of inertia. It is the mass of an object that requires a force to move it. It is usually expressed in kilograms or pounds (mass)*.

In a linear system:

$$M = \frac{W}{g}$$

Momentum: The fundamental measure of an object's motion is momentum. In a linear system, it is the product of the object's mass and linear velocity and is expressed in newton-seconds or pound-seconds:

$$P = Mv$$

Force: The push or pull on an object that causes it to move or accelerate is called force. It is directly proportional to the object's mass and acceleration:

$$F = Ma$$

where M is the object's mass and a is the acceleration.

Rotational Inertia: In linear motion, the inertia of an object is represented by the object's mass:

$$F = Ma, M = \frac{F}{a}$$

It is the mass which tells us how large a force will be required to produce constant acceleration. The rotational analog of this formula is:

$$T = Ia, I = \frac{T}{a}$$

This formula tells us how much torque (T) is required to produce angular acceleration (a). The moment of inertia (I) can be defined as the mass of the object times the

* The pound-mass is a body of mass (0.454 kg). The pound-force is the force that gives a standard pound-mass an acceleration equal to the standard acceleration of gravity (32.174 ft/sec.).

square of the distance (r) from the rotational axis (see Fig. 1-42):

$$I = m_1 r^2 + m_2 r^2 + m_3 r^2 \dots + m_n r^2$$

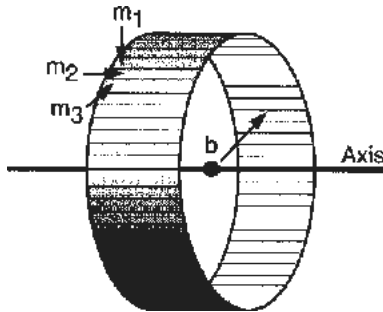

Fig. 1-42: The moment of inertia of a hoop containing many small masses on its circumference.

The moment of inertia can be calculated for any object this way but calculus is usually needed for the summation. Figure 1-43 shows the values of I for several familiar shapes used in mechanical systems.

Figure 1-43 shows that the moment of inertia is always the product of the object's mass and the square of a length. For a hoop, $I = Mr^2$. This leads to a general formula:

$$I = Mk^2$$

where k is the radius of rotation at which the entire mass of the object should be concentrated if the moment of inertia is to remain unchanged. A more standard term for this length is the radius of gyration.

Motor Load and Torque Characteristics

The principles we have just discussed can be applied specifically to motor applications. A motor cannot be selected until the load to be driven and the torque characteristics are determined.

Motor Load: The term "motor load" can refer to horsepower (hp) required by

the driven object or machine. Motor load in hp can be expressed:

$$\text{motor load (hp)} = \frac{2\pi FN}{33000}$$

where r (in feet) is the radius at which the force (F, in pounds) is applied and N is revolutions per minute.

$$\text{motor load (hp)} = \frac{TN}{5250}$$

Where torque (T) is expressed in lb-ft., or if T is expressed in oz-in., then:

$$\text{motor load (hp)} = \frac{TN (9.916 \times 10^{-7})}{5252}$$

Motor load is best described as the torque required by the load. The torque requirement may be dependent upon speed as well. Various conditions place specific demands on torque requirements and they are discussed next.

Breakaway Torque: This is the torque required to start the shaft turning and is usually the torque required to overcome static friction:

Accelerating Torque: This torque may be expressed in percent of running torque. It is the amount of torque needed to accelerate the load from stand-still to full speed, and to overcome friction, windage, product loading and inertia.

Peak Torque: Peak torque is the maximum instantaneous torque that the load may require. High peaks for brief periods are acceptable, but if an application requires sustained torque higher than a motor's peak rating, a different motor should be considered.

Constant Torque: A load with a horsepower requirement that varies linearly with changes in speed is said to have constant torque requirements.



Object	Moment of Inertia (I)	Radius of Gyration (k)
 <p>Hoop</p>	Mr^2	r
 <p>Solid Disk or Solid Cylinder</p>	$\frac{1}{2} Mr^2$	$r\sqrt{2}$
 <p>Solid Sphere</p>	$\frac{2}{5} Mr^2$	$r\sqrt{\frac{2}{5}}$
 <p>Solid Thin Rod</p>	$\frac{1}{12} Ml^2$	$\frac{l}{\sqrt{12}}$
 <p>Annular Cylinder</p>	$\frac{M}{2} (r_1^2 + r_2^2)$	$\sqrt{\frac{(r_1^2 + r_2^2)}{2}}$

Fig. 1-43: Moments of inertia for familiar objects.

Constant Horsepower: This type of load absorbs the same amount of power regardless of the speed.

Variable Torque: Some loads require different torque at different speeds.

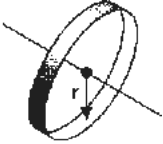
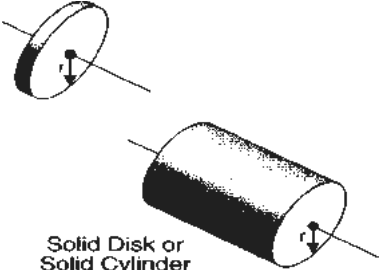
Load Inertia: The load inertia is expressed as:

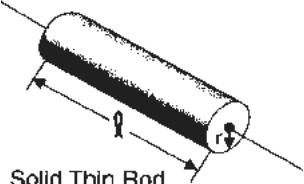
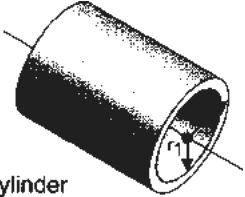
$$I = Mk^2$$

where M is the mass of the rotating parts and k is the radius of gyration.

Acceleration Time: The difference between the friction torque required by the load and the torque delivered by the drive will affect acceleration time. Greater accelerating torque decreases the time

required to get the load to full speed. It can be expressed as:

$$t = \frac{Wk^2 (n_2 - n_1)}{308T_a}$$

where:

t = accelerating time (seconds)

n₂ = final speed (RPM)

n₁ = initial speed (RPM)

T_a = accelerating torque (lb-ft.)

available from the drive

(T_{developed} - T_{friction})

W = weight of rotating system (lbs.)

k = radius of gyration (ft.)

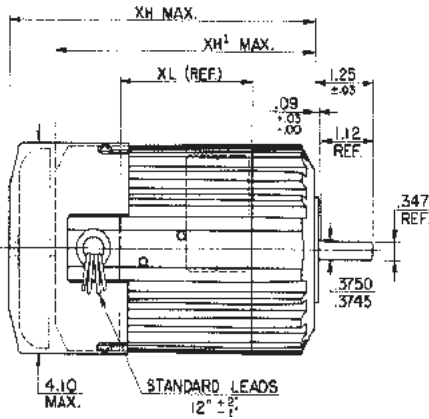

AC Motors

Although commutator and brush assemblies may be used in some types of alternating current motors, brushless induction-type designs are by far the most common for motors operating on AC supplies.

2.1 AC MOTOR ACTION

In an AC motor, the stator winding sets up a magnetic field which reacts with the current-carrying conductors of the rotor to produce rotational torques. The rotor currents are induced in the rotor conduc-

tors by the stator's changing magnetic field, rather than by means of a commutator and brushes. This induction action is the central operating principle of AC induction motors.

AC power is commercially supplied in both single-phase and three-phase forms. The essential operating characteristics of AC induction motors will vary according to:

- 1) winding types (split-phase, shaded-pole, three-phase, etc.), and
- 2) the number of phases, the frequency and the voltage of the power source.

deliberate "skewing" of the slots (position-

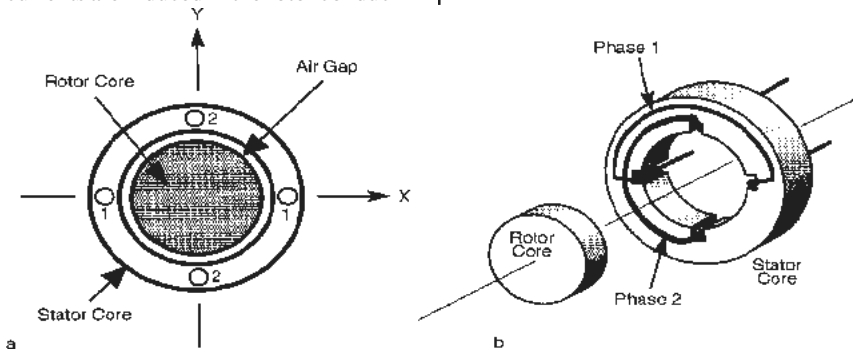

Fig. 2-1: Simplified diagram of a two-phase AC motor (left), and cross-section of a two-phase AC motor showing phase 1 and phase 2 windings (right).

We will consider polyphase motors first, since their operation is somewhat simpler and more easily understood than single-phase machines.

2.2 POLYPHASE (TWO OR MORE PHASES) MOTORS

The production of a rotating magnetic field can be simply illustrated by considering a two-phase motor with two embedded stator windings for establishing the magnetic fields. Each coil, for simplicity, shall consist of a single loop of wire connected to one phase of a two-phase AC supply. We shall refer to the coil supplied by phase 1 current as Coil 1, and the coil supplied by phase 2 current as Coil 2. The two coils are placed at a right angle to each other in the stator core, with each coil creating a two-pole field. See Fig. 2-1.

The output waveform of the two-phase AC supply is represented in Fig. 2-2. The voltage in each phase varies sinusoidally in time and one lags the other by $\pi/2$ radians or 90° (electrical)*.

Let us first consider Coil 1 only. When the phase 1 current is in its positive portion of the cycle (current enters Coil 1 from the right and exits on the left), a magnetic field

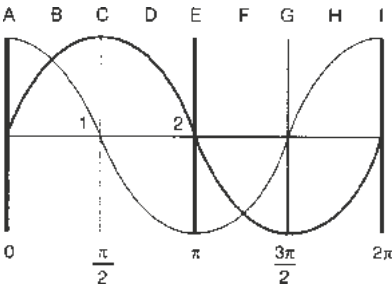

Fig. 2-2: Waveforms produced by two-phase AC.

*One complete cycle = 2π radians or 360° (electrical).

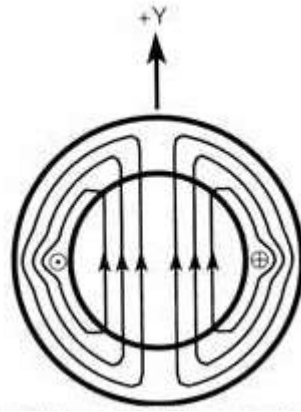

Fig. 2-3: Magnetic field set up when phase 1 is in positive cycle.

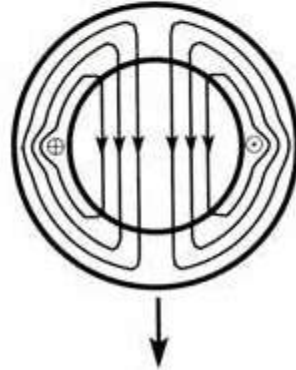

Fig. 2-4: Magnetic field set up when phase 1 is in negative cycle.

is set up which points in the positive (+Y) direction. See Fig. 2-3. When the current flows in the opposite direction during the negative portion of its cycle, the magnetic field points in the negative (-Y) direction. See Fig. 2-4. Since the strength of the magnetic field (H) is proportional to the amount of current flowing through the coil, the field strength also oscillates sinusoidally in time.

Similarly, we can illustrate in Figs. 2-5a and 2-5b the magnetic field due to current flowing in Coil 2.

Now we have two perpendicular fields. Each varies sinusoidally in time, and one lags the other by $\pi/2$ radians. The combined effect (vector sum) of the two fields

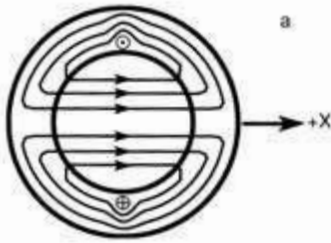

Fig. 2-5a: Magnetic field set up when phase 2 is in positive cycle.

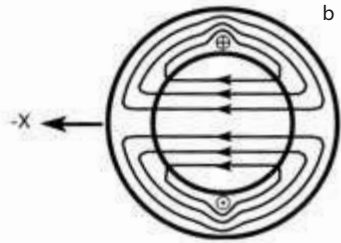

Fig. 2-5b: Magnetic field set up when phase 2 is in negative cycle.

is a rotating resultant field. Figure 2-6 illustrates the progression of the rotation at eight different points in time. The letters (A-H) in Fig. 2-6 correspond to the points (A-H) on the waveform diagram in Fig. 2-2.

It can also be shown mathematically that the magnetic field rotates. If we choose the center of the stator as our reference point, we can define B_y and B_x as the magnitudes of the magnetic flux densities due to the currents flowing through Coil 1 and Coil 2 respectively. Both B_y and B_x are functions of their respective currents* and are functions of time. Also, due to symmetry, their peak values are the same.

Since B_y and B_x vary sinusoidally with their corresponding currents we can express them in the following equations:

$$B_y = B \cos(2\pi ft)$$

$$B_x = B \sin(2\pi ft)$$

where:

B = peak value of either B_y or B_x

f = frequency of the supply current (cycles/unit time)

t = time

Let B_r be the resultant value of B_y and B_x and let ϕ be the angle of B with respect to the axis as shown in Fig. 2-7. For example:

$$\tan \phi = \frac{B \sin(2\pi ft)}{B \cos(2\pi ft)} = \tan(2\pi ft)$$

or

$$\phi = (2\pi ft)$$

Hence, ϕ is increasing at a rate of $2\pi f$ radians per unit time. In other words, B_r is rotating with the same frequency as the supply current.

*This assumes a constant permeability in the ferromagnetic structure.

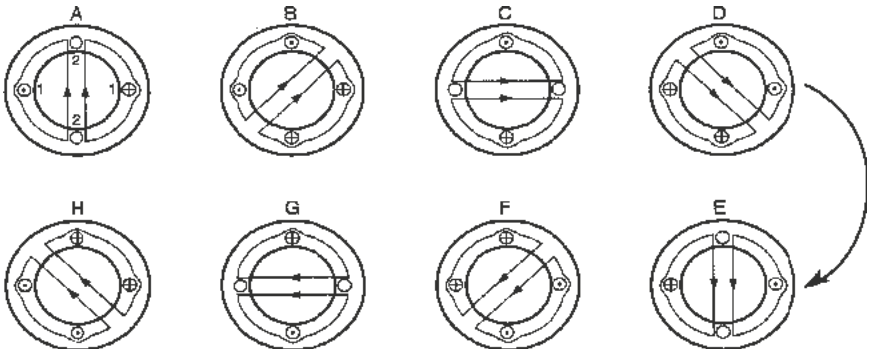

Fig. 2-6: Progression of the magnetic field in a two-phase stator at eight different instants.

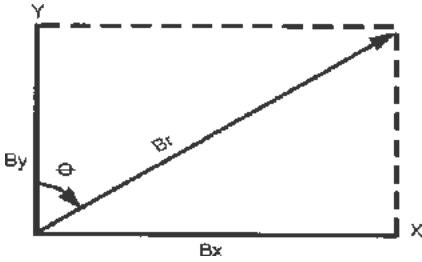

Fig. 2-7: The vector sum of B_y and B_x is resultant field B_r .

can also show that the magnitude of B_r remains constant during rotation, since:

$$B_r^2 = B_y^2 + B_x^2$$

Since B is independent of time, the magnitude of the rotating resultant field (B_r) is constant.

We have demonstrated that a rotating magnetic field is generated in a two-phase stator. These basic analyses can be extended to a three-phase stator and show that it also has a rotating field. Therefore, we will not go into detail with three-phase stators.

The rotor of a typical induction motor is constructed from a series of steel laminations, each punched with slots or holes along its periphery. When laminations are stacked together and riveted, these holes form channels which are filled with a conductive material (usually copper or aluminum) and short-circuited to each other by means of conducting end rings. The conductors are typically formed by die-casting.

This one-piece casting usually includes integral fan blades which create a built-in cooling device. The common term for this type of rotor is "squirrel cage" (because of its resemblance to the runway of an old-fashioned squirrel cage). It is an inexpensive and common form of AC induction rotor. See Fig. 2-8.

As the rotating field sweeps past the bars in the rotor, an induced current is developed. Since the flow of current in a conductor sets up a magnetic field with a cor-



Fig. 2-8: Aluminum conductors in an AC induction rotor. The steel laminations have been removed to illustrate the "squirrel cage" form of the cast aluminum conductors.

responding polarity, an attraction will result between the rotating magnetic field of the stator and the induced field in the rotor. Rotation results from the motor's attempt to keep up with the rotating magnetic field. The rate of change at which the lines of flux cut the rotor determines the voltage induced. When the rotor is stationary, this voltage is at its maximum. As rotor speed increases, the current and corresponding torque decreases. At the point of synchronous speed (speed of the rotating field), the induced current and developed torque both equal zero.

The rotor in a nonsynchronous AC induction motor will always operate at some speed less than synchronous unless it is aided by some supplementary driving device. This lag of the rotor behind the rotating magnetic field is called "slip", and is expressed as a percentage of synchronous speed:

$$\% \text{ slip} = \frac{\text{synchronous RPM} - \text{actual RPM}}{\text{synchronous RPM}} \times 100$$

In designing rotors for induction motors, the shape and dimensions of the slots have a demonstrable effect on the performance characteristics of the motor. This variation is illustrated in Fig. 2-9.

Another design factor common to most squirrel cage induction rotors is the

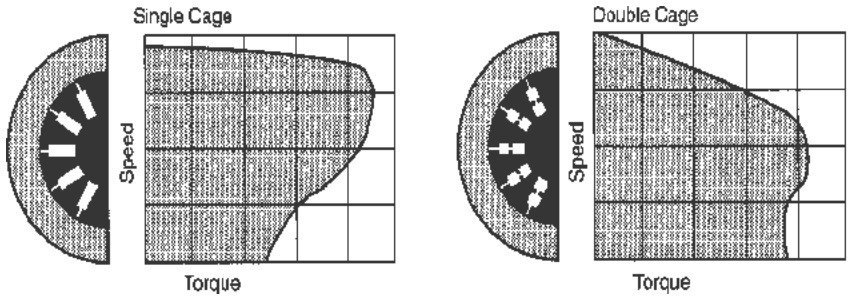

Fig. 2-9: Comparison of speed / torque characteristics for single cage (left) and double cage (right) integral hp rotor design.

ing the slots at a slight angle to the shaft) to avoid cogging action and wide variations in starting torque which may result when bars are placed parallel to the stator slots.

2.3 SINGLE-PHASE

We have demonstrated in the previous section that two-phase and three-phase induction motors will create a rotating magnetic field corresponding to excitation of the stator windings.

In the single-phase induction motor, there is only one phase active during normal running. Although it will pulse with intensity, the field established by the single-phase winding will not rotate. If a squirrel cage rotor were introduced into the air gap between the stator poles of a single-phase motor, it might vibrate intensely but would not initiate rotation. However, the rotor shaft will start to rotate in either direction if given a push.

This rotation sets up an elliptical revolving field which turns in the same direction as the rotor. The “double rotating field theory” and the “cross-field theory” explain why a single-phase motor will rotate if it is started by some means. Due to the complexity of the mathematics involved, they will not be discussed here. What is important to remember is that single-phase AC motors require an auxiliary starting scheme.

2.4 SINGLE-PHASE AC MOTOR TYPES

Single-phase motors, without the aid of a starting device, will have no inherent “starting” torque. To produce torque, some means must be employed to create a rotating field to start the rotor moving. A number of different methods are used. The particular method used determines the “motor type.” An explanation of the various types follows.

Split-Phase (Nonsynchronous)

Features:

- Continuous duty
- AC power supply
- Reversibility normally at rest
- Relatively constant speed
- Starting torque 175% and up (of rated torque)
- High starting current (5 to 10 times rated current)



Fig. 2-10: Split-phase (nonsynchronous) motor.



Fig. 2-11: Typical four-pole, split-phase stator.

Design and Operation: Split-phase motors are perhaps the most widely used relatively constant speed AC motors (of appreciable output) employed for driving domestic appliances. Also used for a variety of industrial applications, motors of this type are relatively simple in construction and lower in cost than most other types. Low cost, plus good efficiency, starting torque and relatively good output for a given frame size have made the split-phase AC induction motor today's general purpose drive. See Fig. 2-10.

Split-phase motors are single-phase motors equipped with main and auxiliary windings connected in parallel (during the start cycle). The auxiliary winding shares the same slots as the main winding, but is displaced in space. See Fig. 2-11. To give

the design its unique starting characteristic, the auxiliary winding is wound with finer wire and fewer turns (for high resistance and low reactance) than the main winding, and the current flowing through it is substantially in phase with the line voltage. The current flowing through the main windings, because of their lower resistance and higher reactance, will tend to lag behind the line voltage in time. This lagging effect will act to "split" the single-phase of the AC power supply by causing a phase (time) displacement between the currents in the two windings.

The space and phase displacement of the main and auxiliary windings produce a rotating magnetic field which interacts with the rotor to cause it to start (begin rotating). After the split-phase motor has attained approximately 70% of rated speed, the auxiliary winding is automatically disconnected from the circuit by means of a centrifugal switch or current sensitive relay. The motor will then continue to run on the single oscillating field established by the main winding. See Figs. 2-12 and 2-13.

Advantages: Split-phase motors will operate at relatively constant speed, typically from about 1790 RPM at no load to 1725 or 1700 RPM at full load for a four-pole, 60 Hz motor.

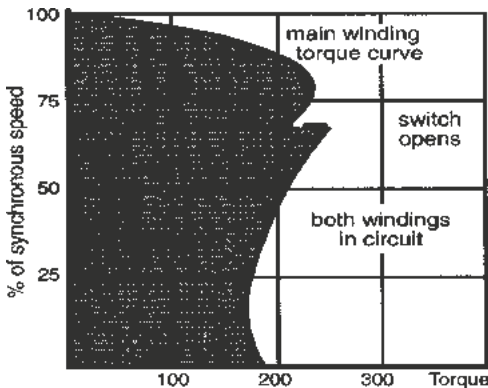

Fig. 2-12: Speed / torque curve for a typical split-phase AC motor.



Fig. 2-13: Example of a centrifugal cutout mechanism used on split-phase motors.

A standard four-wire split-phase motor can be reversed at standstill or while operating at a speed low enough to ensure that the auxiliary winding is in the circuit. Split-phase designs can also be reversed at full speed if a special switching device is used to connect the starting winding in the reverse direction sufficiently long to reverse the motor. This normally is not done, however, because of the danger of burning out the starting winding during a long reversal period.

Perhaps the most important feature associated with split-phase motors is their relatively low initial cost. The high starting torque combined with simple, reliable construction make split-phase AC motors ideal for many general purpose applications.

Since the rate at which the motor can be accelerated is often a primary concern to the applications engineer, split-phase designs are often specified because of their ability to come up to speed rapidly (reaching running speeds with normal loads in a fraction of a second).

Disadvantages: Because of the high resistance of the starting winding, repeated starting and stopping will heat the windings (in particular, the starting winding) and result in loss of torque and possible winding damage. This is one of the reasons why it is not practical to apply split-phase motors when very frequent

starts are required, or where high inertial loads must be accelerated.

Split-phase motors have a high starting current which can range from 5 to 10 times the current drawn while running. If the starting load is heavy, the wiring between the motor and the power source must be of adequate size to prevent excessive voltage drop. The low voltage conditions resulting from inadequate wire size will result in decreased motor starting torque. Frequent starts, coupled with inherent high starting current, can also adversely affect starting switch or relay life.

Cautions: The auxiliary starting winding in a split-phase motor is designed for very short duty. If it stays in the circuit for more than a few seconds, the relatively high starting current which it draws can cause overheating of the winding. Should this happen, a more powerful motor or a motor having different electrical characteristics should be considered.

Caution should be used when driving high inertial loads with split-phase motors. This type of load can prolong the acceleration and “hang” too long on the starting winding.

Capacitor (Nonsynchronous)

Features:

- Continuous duty
- AC power supply
- Reversibility at rest or during rotation, except split-phase capacitor start which is normally at rest only
- Relatively constant speed
- Starting torque 75% to 150% of rated torque
- Normal starting current (3 to 7 times rated current)



Fig. 2-14: Capacitor (nonsynchronous) gearmotor.

Design and Operation: Capacitor action described in Chapter 1 has been found to provide specific performance improvements when used with single-phase AC motors. See Fig. 2-14. The types of capacitors used and the method of operation varies with motor type (see Fig. 2-15.). The operating characteristics of each type are quite different and will be treated separately. In general, there are three distinct capacitor motor types:

- a) *Capacitor Start (CS)*— motors use one electrolytic capacitor in the starting mode only,
- b) *Permanent Split Capacitor (PSC)*— motors may operate with one permanently-connected, continuous-duty AC-type capacitor for both starting and running, and
- c) *Two Capacitor Start/One Capacitor Run* — motors use one continuous-duty AC-type and one electrolytic capacitor in the start mode and switch out the electrolytic capacitor while running.

Capacitor Start (CS): The capacitor start motor is essentially a split-phase motor which has two separate windings: a main or, “running” winding and an auxiliary or “starting” winding. However, in the capacitor start motor, an electrolytic capacitor is added in series with the start winding during the starting mode to increase starting torque and/or reduce starting current. As in the case of the split-phase design, the starting winding and

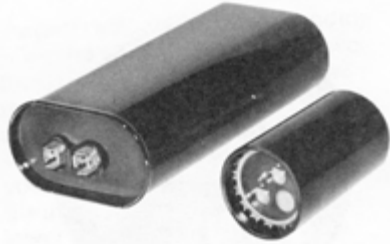

Fig. 2-15: Comparison of continuous-duty AC-type capacitor and electrolytic capacitors.

capacitor will be disconnected when the motor has reached approximately 70% of running speed.

Like the conventional split-phase motor, the capacitor start design runs with only the main winding energized. This “run” winding sets up a pulsating magnetic field which interacts with the rotor to develop the necessary running torque and speed. Since the “run” winding alone has no starting capability, both starting and running windings are energized while starting. Because of the high resistance-to-inductance ratio of the “start” winding relative to the “run” winding, the currents in the two windings (when energized) are sufficiently displaced (time-wise) from each other to produce a rotating magnetic field and the necessary torque for starting.

The addition of a capacitor, in series with the “start” winding, can significantly enhance the starting characteristics by improving the phase relationship between the “run” and the “start” windings. With the proper selection of capacitor value, the starting torque can be increased and/or the starting current decreased. Of course, capacitor values must be carefully selected to produce this effect. Because the CS motor’s capacitor is used only when starting, its duty cycle is very intermittent. Thus, an inexpensive and relatively small AC electrolytic-type capacitor can be used in CS designs. The normal, non-polarized, AC electrolytic capacitor consists of two

aluminum plates separated by a porous paper which is saturated with an electrolyte.

Permanent Split Capacitor

(PSC): When split-phase or capacitor start (CS) motors are applied in applications which require long or frequent starts, the motor may tend to overheat and adversely affect the system reliability. In this type of application, PSC motors should be considered.

The PSC capacitor winding is permanently connected in series with a continuous-duty AC-type capacitor. In contrast to the split-phase or capacitor start motor, the “second” winding is energized at all times. The capacitor used with PSC designs is rated for continuous duty and consists of aluminum plates separated by a film dielectric.

Permanent split capacitor motors operate in much the same way as two-phase AC motors. The capacitor in the PSC design causes the current in the capacitor winding to be out of phase (with respect to time) with the current in the main winding, thus a rotating magnetic field is created. This action gives the PSC motor greater efficiency and quieter, generally smoother operation than the split-phase and the split-phase capacitor start designs. See Fig. 2-16.

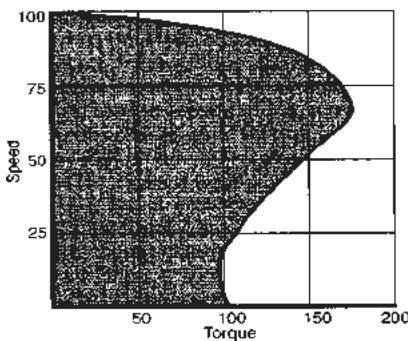

Fig. 2-16: Typical performance of a 1/15 hp (50 watt) PSC motor.

Two Capacitor Start/One

Capacitor Run: A variation on the permanent split capacitor design, the two capacitor motor uses an electrolytic capacitor for starting in addition to the continuous-duty AC-type capacitor used for both starting and running. The use of two capacitors helps to preserve the efficiency and quietness of the PSC motor while running and produces a corresponding improvement in the starting characteristics. If we increase the value of the capacitor in a PSC motor, we can normally improve starting torque, but at the expense of running performance. However, by using two capacitors (one for running and two in parallel for starting), optimum running and starting characteristics can be obtained.

To understand how this works, it is important to realize that the magnitude of the current flowing in the capacitor winding changes with the speed of the rotor. The value of the current in the capacitor winding is lowest when the rotor is at zero speed, and highest when the rotor speed is at its maximum. A capacitor and capacitor winding combination that is optimized for “locked rotor” or starting conditions will not be optimum for normal running operation. The watt input while running will be high, and the current in the capacitor winding will not lead the main current by the ideal 90 degrees, resulting in inefficient operation.

A capacitor and capacitor winding optimized for running will be correspondingly less efficient in the starting mode. The use of two capacitors for starting and one for running overcomes the compromise made in the PSC designs.

Advantages: In addition to the improved starting torque characteristics made possible by the capacitor in the capacitor start split-phase design, the reduction of starting current reduces the effect on other equipment due to line voltage drop

encountered with high starting current split-phase designs. Lower starting current will also contribute to longer life and greater reliability in switches and relays.

In general (for a given horsepower rating), although the permanent split capacitor motor is more expensive than split-phase and capacitor start designs, it produces quieter operation and provides the frequent start/stop capability essential in many applications.

Disadvantages: Since the phase angle in PSC motors changes with an increase in load, performance will usually be less satisfactory while starting. In usual design practice, a compromise must therefore be made between the starting and running modes. Changing the capacitor value specified by the manufacturer will affect both running and starting characteristics so that any improvements in starting will usually result in a decrease in running performance.

Cautions: While an optimum capacitor value can enhance motor performance, an improper value of capacitance can decrease performance. It is, therefore, advisable to use the rated capacitor value recommended by the manufacturer (on the nameplate). Any change from the rated value is usually detrimental to the design and is not encouraged. When a failed capacitor is replaced, it should always be replaced with a capacitor of equal capacitance and voltage rating. Voltage rating is important for continued reliability and safety.

It should also be noted that PSC motors should be run at or near their rated load points. Unlike other motor types, PSC designs will tend to run hotter if lightly loaded or unloaded.

Shaded Pole (Nonsynchronous)

Features:

- Continuous duty
- AC power supply
- Unidirectional reversibility
- Relatively constant speed
- Starting torque 50% to 80% of rated torque
- Low starting current



Fig. 2-17: Shaded pole (nonsynchronous) motor.

Design and Operation: A simple and economical drive, the shaded pole motor (Fig. 2-17) is used in countless consumer and industrial applications ranging from room air conditioners to advertising displays. Shaded pole motors have no internal switches, brushes or special parts, and therefore offer substantial cost savings in applications requiring relatively constant speed and low power output.

While split-phase motors make use of a high resistance auxiliary or “starting” coil wound similar to the main winding, shaded pole designs use an entirely different type of stator lamination which allows for a set of salient poles* surrounded by the main windings.

*A motor stator has salient poles when its poles are concentrated in relatively confined arcs and the winding is wrapped around these poles (as opposed to distributing the winding in a series of slots)

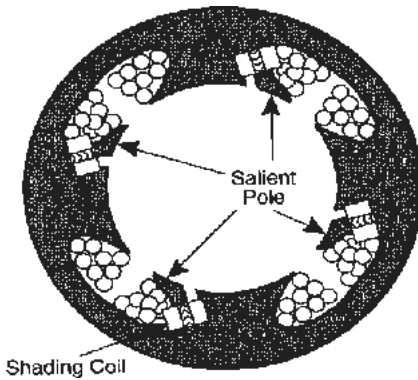

Fig. 2-18: Cross-section of a typical shaded pole motor. Note the larger salient poles and the smaller shading poles on one side.

Salient poles are broad radial projections (equal in number to the number of poles) distributed around the active surface of a rotor or stator and around which windings may be coiled. See Fig. 2-18. These are full pole pitch windings which are fractionally distributed in a series of slots.

Embedded in a portion of the face of each salient pole is a single turn of conducting material, usually copper. These turns are known as shading coils. The main winding in a shaded pole motor is connected to the power supply, while the shading coils form closed circuits on themselves.

The time-varying magnetic field set up by the alternating current in the main winding induces a current in the shading coils. This induced current will, in turn, establish an additional magnetic field in the shaded part of the pole face. This additional field lags behind the main winding field in time. With the main and shading coils displaced from each other, a moving or revolving magnetic field is set up in the stator which interacts with the squirrel cage rotor to produce rotation in a direction from the center of the salient stator pole toward the shaded pole tips.

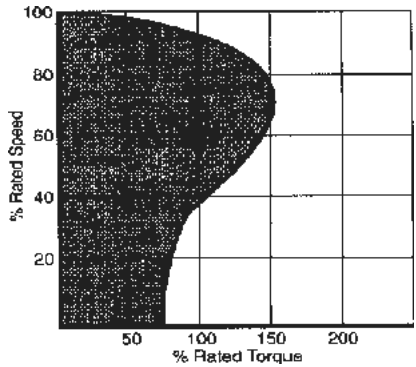

Fig. 2-19: Typical characteristic curve for a 1/150 hp (5 watt) shaded pole motor.

Advantages: Above all, the shaded pole motor is simple in design and construction, making it readily adaptable to high-volume, low-cost production. Because there are no internal switches, brushes or special parts, motors of this type can be extremely dependable. Depending upon construction, shaded pole motors are relatively quiet and free from vibration. Shaded pole designs are normally available in sizes from subfractional to approximately 1/4 hp (186 W).

The shaded pole motor is classified as a relatively constant speed machine, and running efficiency will increase with load. Variation in applied load will not significantly affect motor speed, providing that the motor is not overloaded. See Fig. 2-19.

Normal shaded pole designs also offer the “fail-safe” feature of starting in only one direction. With split-phase and capacitor start motors, there is always the remote possibility that they may start in reverse in some failure modes (cutout switch doesn’t operate, open winding, etc.)

Disadvantages: Although a shaded pole motor is rugged and inexpensive. It typically has low starting torque and running torque.

Efficiency is also low, making shaded pole motors impractical beyond fractional horsepower sizes. Shaded pole motors are generally used on light-load applications where heat can be tolerated or supplemental cooling is available.

While efficiency is relatively low, for applications requiring minimal power output, this limitation is compensated for by its lower initial cost. However, with today's increased emphasis on energy savings, shaded pole motor operating costs over the life of the application should be examined.

2.5 SYNCHRONOUS (POLYPHASE AND SINGLE-PHASE)

The “difference” between the speed of the rotating magnetic field of an induction motor (which is always synchronous) and the speed of the rotor is known as “slip.” When the rotor design enables it to “lock into step” with the field, the slip is reduced to zero and the motor is said to run at synchronous speed. Upon reaching the running mode, synchronous motors operate at constant speed — the speed being dependent on the frequency of the power supply. This constant speed feature makes synchronous motors a natural drive for timing and other applications requiring a constant speed output.

Design and Operation: There are two common types of small synchronous motors, classified according to the type of rotor used:

- a) reluctance synchronous motors, and
- b) hysteresis synchronous motors.

Reluctance Synchronous: A variation on the classic squirrel cage rotor, the reluctance synchronous rotor is modified to provide areas of high reluctance.

This may be done by designing notches (or flats) in the rotor periphery. The number of notches will correspond to the number of poles in the stator winding. The sections of the rotor periphery between the high reluctance areas are known as salient poles. Since these poles create a low reluctance path for the stator flux, they are attracted to the poles of the stator field.

The reluctance synchronous rotor starts and accelerates like a regular squirrel cage rotor, but as it approaches the rotational speed of the field, a critical point is reached where there is an increased acceleration and the rotor “snaps” into synchronism with the stator field. If the load (particularly inertial) is too great, the motor will not attain synchronous speed. Motor “pull-in” torque is defined as the maximum load that the motor can accelerate and pull into synchronism at rated voltage and frequency. An applied load greater than the rated “pull-in” torque will prevent the motor from pulling the load into synchronism and will result in rough, nonuniform operation.

The phase relationship between the poles of the rotating field and the rotor is known as the coupling angle, expressed in mechanical degrees. This coupling angle is not rigid, but will “increase” with an increase in load. At no load, the rotor poles will line up with the field poles and the coupling angle is considered to be zero.

When a load is applied to reluctance synchronous motors, the magnetic lines of force coupling the rotor to the stator field are stretched, increasing the coupling angle. If the load is increased beyond the motor's capability, the magnetic coupling between the rotor poles and stator field will break, and the rotor will “pull out” of synchronism. “Pull-out” torque is defined as the maximum torque the motor can deliver at synchronous speed.

Reluctance synchronous motors may be designed for polyphase operation, as well



Fig. 2-20: Comparison of typical reluctance synchronous rotors (top) and hysteresis synchronous rotors (middle and bottom).

as single-phase versions in split-phase, CS and PSC configurations. These motors have characteristics comparable to their nonsynchronous counterparts using the same types of stator windings. For comparable output in a given frame size, the polyphase or PSC reluctance synchronous motor will provide quieter operation and more nearly uniform angular velocity than the split-phase or CS reluctance synchronous motor. As shown in Fig. 2-20, the reluctance rotor can be skewed to improve smoothness of operation.

Hysteresis Synchronous:

Although the stator in a hysteresis synchronous design is wound much like that of the conventional squirrel cage motor, its rotor is made of a heat-treated cast permanent magnet alloy cylinder (with a nonmagnetic support) securely mounted to the shaft. The motor's special performance characteristics are associated with its rotor design. The rotor starts on the hysteresis principle and accelerates at a fairly constant rate until it reaches the synchronous speed of the rotating field.

Instead of the permanently fixed poles found in the rotor of the reluctance

synchronous design, hysteresis rotor poles are "induced" by the rotating magnetic field. During the acceleration period, the stator field will rotate at a speed faster than the rotor, and the poles which it induces in the rotor will shift around its periphery. When the rotor speed reaches that of the rotating stator field, the rotor poles will take up a fixed position.

Like the reluctance synchronous motor, the coupling angle in hysteresis motors is not rigid, and if the load is increased beyond the capacity of the motor, the poles on the periphery of the rotor core will shift. If the load is then reduced to the "pull-in" capacity of the motor, the poles will take up fixed positions until the motor is again overloaded or stopped and restarted.

The hysteresis rotor will "lock-in" at any position, in contrast to the reluctance rotor which has only the "lock-in" points corresponding to the salient poles on the rotor.

Advantages: Synchronous motors operate at a constant speed fixed by the number of stator poles and the frequency of the power supply. Within the limitations of "pull-out" torque and no variation in line frequency, the speed can be considered constant.

Hysteresis synchronous motors, with their uniform acceleration characteristics, can pull into synchronism any load that is within their capacity to start and accelerate.

Disadvantages: Synchronizing characteristics of the reluctance motor require increased acceleration of the rotor at the critical point when it approaches the rotational speed of the field. For this reason, it is possible that while the reluctance motor may easily start a high inertia load, it may not be able to accelerate the load enough to pull it into synchronism. If that should happen, the reluctance motor would operate as an ordinary induction motor, but at low efficiency and very irregular angular

velocity (audibly detected as a pounding noise). It is important, when applying synchronous motors, to be certain that they will accelerate the loads to synchronous speed under the most adverse load and voltage conditions. See Fig. 2-21.

In general, synchronous motors should only be applied in cases where the load needs to be driven at an exact rate of speed. For a given horsepower, synchronous motors are usually larger and more costly than nonsynchronous motors. In other words, for a given frame size, synchronous motors (vs. nonsynchronous) have lower hp ratings and tend to be more expensive. Stated still another way, a synchronous motor will often be larger than a nonsynchronous motor to drive a given application. Because of these factors, synchronous motors tend to be applied only where the synchronous feature is absolutely necessary.

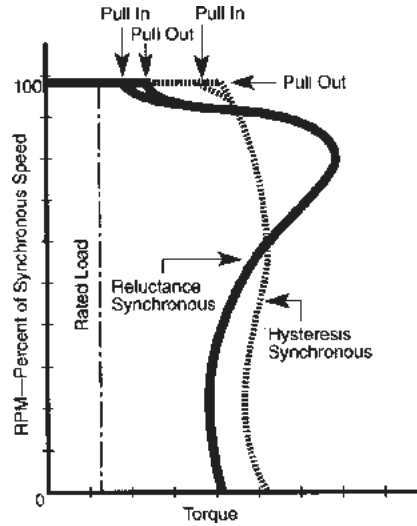
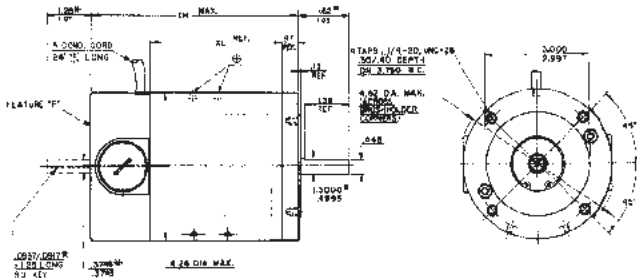

Fig. 2-21: Comparison of typical speed curves for hysteresis and reluctance synchronous motors of identical frame size.



Commutator (DC) Motors

Although similar in some respects to the generators described in Chapter 1, motors have an opposite function in energy conversion. While generators convert mechanical energy into electrical power, motors convert electrical energy into mechanical turning force or torque.

3.1 BRUSH-TYPE DC MOTOR ACTION

When a current-carrying conductor is placed in, and at a right angle to, a magnetic field, it will experience a force perpendicular to the field and to itself. The direction of the force in relation to the field and current is shown in Figs. 3-1a and b. The force on this conductor is proportional to the flux density, current and the length of the conductor.

Using the above principle, we can explain the motor action of a simple single loop armature as shown in Fig. 3-1c, where DC current enters the right side of the loop and exits the left. The resultant forces acting on the single loop armature generate a clockwise torque. However, the torque diminishes to zero as the plane of

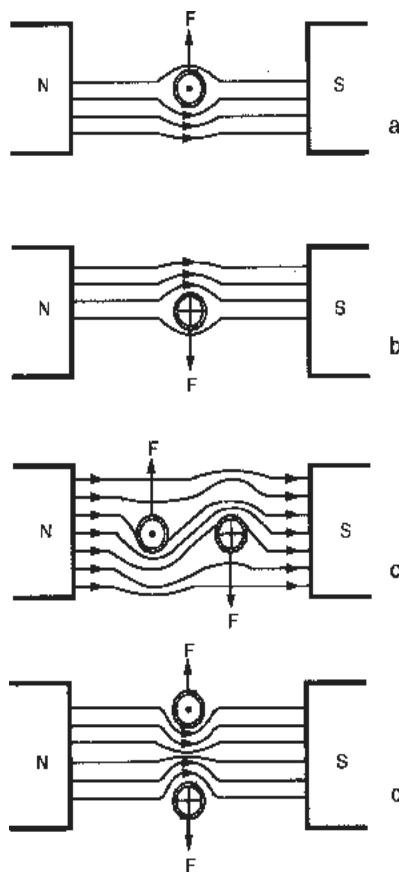

Figs. 3-1a, b, c, d: Upward and downward forces created by interaction of field and armature flux.

the armature coil becomes perpendicular to the field as shown in Fig. 3-1d.

Commutation: In order to continue the clockwise motion of our simple single loop armature, we need a commutator arrangement as shown in Fig. 3-2a. As the coil becomes perpendicular to the magnetic field, the direction of current in the coil reverses, causing the forces acting on the coil to switch their direction. The coil then continues to rotate in a clockwise direction.

The torque produced on the armature is

proportional to the sine of the angle between the magnetic field and the plane of the rotating coil. The torque will produce a ripple type waveform as shown in Fig. 3-2b. This figure shows that the resulting torque reaches zero at the two vertical positions during the armature (loop) rotation. This simple motor relies on the inertia of the armature to carry it through the zero torque points to continue its rotation.

To eliminate this effect and keep a level of torque always at some point above zero.

Fig. 3-2a.

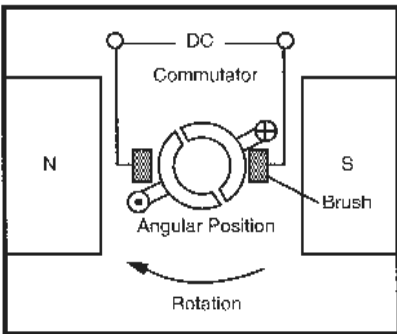

Fig. 3-2b.

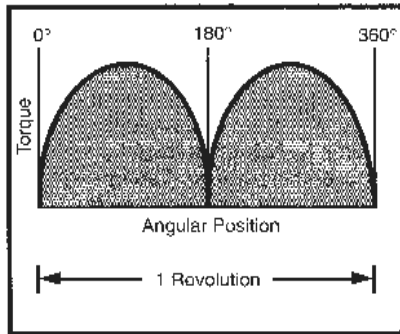

Fig. 3-2c.

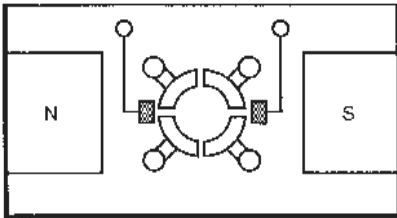

Fig. 3-2d.

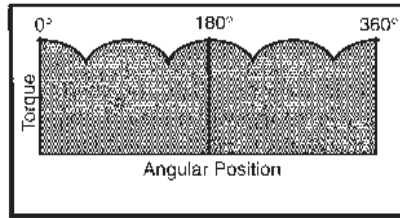

Fig. 3-2e.

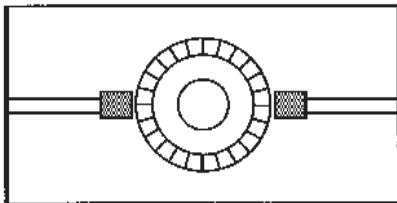

Fig. 3-2f.

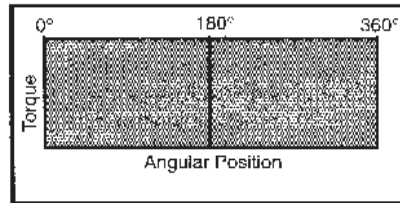

Fig. 3-2: Relationship of commutator segments and torque: a) two-segment commutator, b) two-segment commutator torque curve, c) four-segment commutator, d) four-segment commutator torque curve, e) 32-segment commutator, and f) 32-segment commutator torque curve.

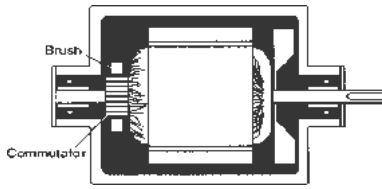

Fig. 3-3: Commutator and brush position in a typical DC motor design.

a four-segment commutator and two armature coils may be used (Fig. 3-2c). This arrangement staggers forces to keep the torque at an acceptable level. The torque/position curve will then look like Fig. 3-2d. The more segments added to the coils and corresponding commutator armature, the closer the torque curve will approximate a straight line characteristic. See Figs. 3-2e and f.

Figure 3-3 shows the position of a commutator in relation to the armature coils of a typical DC motor.

Counter emf and Armature Current: When a DC armature is rotating in a magnetic field, there is an induced voltage produced in the armature which takes the form of an opposing or counter-electromotive force (cemf). When the flux field is held constant, this voltage is proportional to the armature speed. Motor action will continue as long as the voltage supplied to the commutator is greater than the cemf. The cemf limits the current flowing in the armature according to the formula:

$$V = IR + cemf$$

where V is the source voltage, I is the armature current and R is the armature resistance. It is inherent that the current in the armature is proportional to the load or torque produced. The current increases with an increasing load until the motor stalls, at which point the cemf is equal to zero.

Speed Control: The speed of a DC motor is easily controlled by adjusting

the voltage either in the field or armature or a combination of both. This can be accomplished by means of controls, variable resistors and other devices and will be discussed in detail in Chapter 8.

Having briefly reviewed the fundamental operation of commutator motors, we will now consider each electrical type individually.

3.2 BRUSH-TYPE DC MOTORS

Series Wound

Features:

- Continuous or short time duty
- AC or DC power supply
- Usually unidirectional reversibility
- Speed varying with load
- Starting torque 175% and up of rated torque
- High starting current



Fig. 3-4: Series wound motor.

Design and Operation: Series wound motors are among the most popular of fractional and subfractional hp motor types. Capable of operation on either AC or DC power supplies, series motors deliver high motor speed, high starting torque and wide speed capability, making them ideal drives for a variety of applications. See Fig. 3-4.

The armature and field of a series motor are connected in series with respect to the

line. This feature allows series motors to be operated from either AC or DC supplies between 0 and 60 Hz. Because of their “dual” capability, series motors are often called “universal.” The performance difference of a universal motor between 50 and 60 Hz is generally negligible. It should not be assumed, however, that all series motors are universal. Some may be optimized for a particular power supply, and perform poorly or fail prematurely if operated on a power supply substantially different from that specified on their nameplates.

Actually, no universal motor has the same performance on both AC and DC. Usually, the motor will run slower on AC than on DC because the windings exhibit a higher impedance when operated on an AC supply. The speed difference is most apparent with higher loads. Sometimes the AC vs. DC speeds can be more closely matched if a properly specified resistor is placed in series with the motor when operated on DC.

At lighter loads, an opposite speed relationship may occur. Since the effective field strength is lower on AC, the motor may run faster.

Advantages: In addition to their versatility, series wound motors have the highest horsepower per pound and per dollar of any motor that operates directly from standard single-phase AC power. This factor accounts, in part, for the popularity of series motors in household appliances and power tools. The economics are closely related to the inherent high speeds of series motors. For example, a typical AC induction motor rated at 1/10 hp (75 watts) at 1725 RPM weighs approximately 15 lbs. (67 newtons). A series universal motor rated at 1/10 hp (75 watts) and 10,000 RPM can weigh under 4 lbs. (18 newtons).

Although there is a dramatic savings in weight and cost per hp delivered, there

are other aspects to the comparison:

- a) At the stated rating point in our foregoing example, the torque of the induction motor will be 58 oz-in. (410 mN-m), compared with 10 oz-in. (71 mN-m) for the series motor.
- b) The induction motor will have much better speed regulation (less change in speed with variations in load).
- c) The induction motor will be significantly quieter because of its lower speed and absence of commutating brushes.
- d) The induction motor will not have the maintenance and service life considerations associated with brush commutation.

In spite of these differences, series motors are uniquely suited to a variety of applications. In particular, series motors are the only small motors capable of more than 3600 RPM operating directly from a single-phase (60 Hz) AC power supply. Also, the series motor will provide higher starting torque than any other motor of equivalent physical size operated from similar power supplies. Used as a DC motor, the series design is practical up to about the 5" diameter size range. Above that, PM and shunt-wound motors become practical in a cost/performance trade-off.

Although series motors are usually supplied as unidirectional (to obtain greater efficiency and brush life) bidirectional series motors can also be produced. One method accomplishing this is a three-wire design which can be reversed with a simple single pole/double throw (SPDT) switch. However, for this arrangement, a split or double field winding is required, reducing the available hp in a given frame.

An alternative to the three-wire method is the four-wire series motor which is made reversible by transposing the armature leads, usually with a double pole/double

throw (DPDT) switch. With reversible series wound motors, the application must be able to tolerate some variations in speed between one direction and the other, due mainly to inherent differences in commutation until the brushes seat adequately in each direction.

In addition to the advantages discussed above, series motor speed can be adjusted over a broad range by using a rheostat, an adjustable autotransformer or an electronic control. With the application of a mechanical governor attached to the motor shaft, a series motor can also provide a constant speed over a wide torque range.

The no-load and operating speeds of series motors are usually quite high. No-load speeds in excess of 15,000 RPM are common and are limited only by the motor's own friction and winding characteristics. Normal operating speeds are from 4000 to 10,000 RPM. The excellent forced ventilation made possible at these speeds helps to yield much higher horsepower ratings than "common" induction motors operating at 1725 to 3450 RPM.

Disadvantages: A series motor inherently provides poor speed regulation and is classified as having a varying speed characteristic. This means that the speed will decrease with an increase in load and increase with a decrease in load. The amount of change will depend upon the particular motor design. Speed changes are more pronounced because the armature and field are connected in series.

As the load is increased, the motor must slow down to let more current flow to support the load. This increase in current, however, increases the strength of the field, and thus the counter emf, which has a limiting effect on current build-up. The result is a further decrease in speed to compensate for this change. However, the simultaneous change in field and armature strength cause the two to always be matched or balanced

resulting in the excellent starting torque characteristic of the series motor.

Although high speed is often a significant advantage, it does not come without a "price." Specifically, bearing and brush life are affected by high speed (household appliance series motors typically have a brush life of 200 to 1200 hours, depending on the type of appliance). Centrifugal forces must also be analyzed to prevent the destructive effects of imbalance at high speeds. These factors generally limit series motors to intermittent duty applications. However, series motors have been successfully applied in many continuous duty applications where operating conditions are favorable, or where the nature of the application provides for a moderate amount of servicing.

Cautions: Because of the steepness of the speed/torque curve near the no-load point, operation at or near no-load is usually discouraged. See Fig. 3-5. If consistent performance between motors or even in the same motor is desired, series motors should be operated at some load value beyond this point. The slope of the speed/torque curve, along with the point of peak

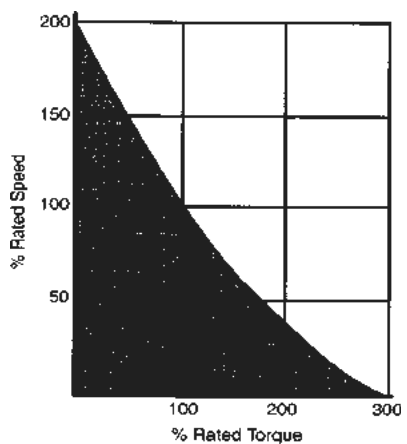

Fig. 3-5: Typical characteristic curve for a series type (universal) motor.

efficiency, can be altered slightly by the motor manufacturer to suit specific applications.

An additional caution—series motors designed and built for one direction of rotation should never be reversed (extremely poor brush life and performance can be expected).

Shunt-Wound



Fig. 3-6: Shunt-wound motor.

Features:

- Continuous duty
- DC power supply
- Reversibility at rest or during rotation
- Relatively constant and adjustable speed
- Starting torque 125% to 200% of rated torque
- Normal starting current

Design and Operation: One of the earliest and most versatile types of DC motors, the shunt-wound design has always enjoyed considerable popularity as an excellent electrically adjustable, relatively constant speed drive. With solid state control circuitry and its inherent relatively constant speed characteristics, the shunt-wound DC motor is a valuable companion to advanced SCR (Silicon Controlled Rectifier) controls. See Fig. 3-6.

The shunt-wound DC motor has both a wound field and armature with spring-loaded brushes applying power directly to the armature by means of a segmented commutator. The term “shunt” is derived from the connection of the field and armature in parallel (shunt) across the power supply. See Fig. 3-7b. The field and armature may also be separately excited from two independent sources. This allows changes in armature voltage to vary the speed while still maintaining a constant field voltage.

Advantages: The shunt motor inherently provides good speed regulation (changes in load only slightly affect speed within its rated torque range).

For example, a 1/4 hp shunt motor operating at a rated speed of 1725 RPM will generally not vary in speed from no-load to

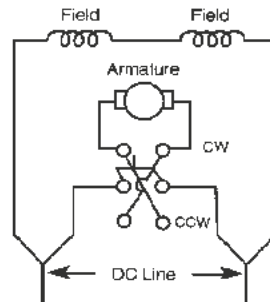
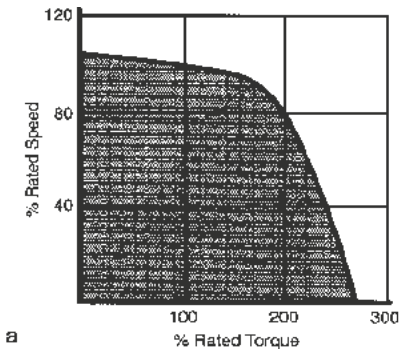

Fig. 3-7: a) Typical shunt-wound motor performance curve (left), and b) typical shunt-wound motor wiring diagram (right).

full load by more than 15%. With modern feedback-type controls, the speed regulation can be even further improved to $\pm 1\%$ or less over a defined speed range, without an add-on tachometer. Tight control over a wider speed range may require sacrifices in regulation to compensate for the wide speed range feature. A tachometer, feedback or closed-loop control may also be needed.

The most common means of controlling shunt motors is the adjustment of armature voltage while maintaining constant field voltage. Armature voltage control is normally used to decrease the motor speed below its base speed. Regulation and starting torque are generally not affected, except at the very lowest speeds. A totally enclosed shunt motor can be designed to operate at rated torque down to zero RPM without developing excessive temperatures.

Another method, field weakening, may also be used to vary motor speed. It is, however, usually used only to increase the motor speed above its base speed and is not often recommended unless the load is decreased to maintain a constant horsepower output. In addition, the percent of regulation is increased and the starting torque decreased with the field weakening method.

Normal NEMA* speed ratings (base speed) for shunt motors operated from electronic controls are 1140, 1725, 2500 and 3450 RPM, but a shunt motor can be wound to operate at any intermediate speed for special purpose applications. This same flexibility, within limits, also applies to shunt motor voltage ratings.

Shunt designs are reversible at rest or during rotation by simply reversing the armature or the field voltage. Because of the high inductance of the field circuit, reversing the armature is the preferred method.

Disadvantages: If the shunt-wound motor is operated from a fixed voltage supply, a decrease in speed will occur as the motor is loaded. The decreasing speed with increased load tends to be linear over a range in which the magnetic characteristics are linear. As load is increased, further saturation begins to occur, resulting in what is commonly known as armature reaction and the resultant abrupt drop in speed, as shown in Fig. 3-7a. The speed also increases linearly with increasing armature voltage, making the shunt-wound design valuable as an adjustable speed motor. The fact that speed varies proportionally with armature voltage makes it possible to vary speed over a wide range with electronic controls.

Cautions: Reversing the armature while it is rotating is called “plugging” or “plug reversal.” Because of the counter-electromotive force (cemf) or generated voltage in the armature, plugging will subject the armature to approximately twice the rated voltage and therefore should be used with discretion.

Dynamic braking, while not as severe as plugging, should also be used with caution. A shunt motor can be dynamically braked by “shorting” the armature after it has been disconnected from the line. Current-limiting resistors are generally used to reduce the severity of this operation.

Brush life on a shunt-wound motor is usually good. However, severe duty cycles, like plugging and dynamic braking, can adversely affect brush life. Such applications should be carefully studied to prevent excessive stress to brushes and other motor parts. With direct current, an electrolytic action takes place which causes one brush to wear faster than the other. This is a normal condition. The quality of

*NEMA is the national Electrical Manufacturers Association.

the DC wave shape coming from the control will also have an important effect on brush life. Recognizing these precautions and using a careful and intelligent approach to shunt-wound motor application will usually guarantee long and successful brush and motor life.

Permanent Magnet (PM)



Fig. 3-8: Permanent magnet motor.

Features:

- Continuous duty
- DC power supply
- Reversibility at rest or during rotation with current limiting
- Relatively constant and adjustable speed

- Starting torque 175% and up of rated torque
- High starting current, relative to full load running current

Design and Operation: Historically, permanent magnet field motors provide a comparatively simple and reliable DC drive in applications requiring high efficiency, high starting torque and a linear speed/torque curve. With the great strides made in ceramic and rare earth magnet materials, combined with electronic control technology, the PM motor has taken on a new importance as an adjustable speed drive delivering significant performance in a relatively compact size. See Fig. 3-8.

The single design feature which distinguishes the PM field motor from other DC motors is the replacement of the wound field with permanent magnets. It eliminates the need for separate field excitation and attendant electrical losses in the field windings. The armature and commutator assembly in conventional PM motors is similar to those found in other DC types. See Fig. 3-3.

Advantages: Perhaps the most important advantage of PM field motors is their smaller overall size made possible by replacing the wound field with ceramic

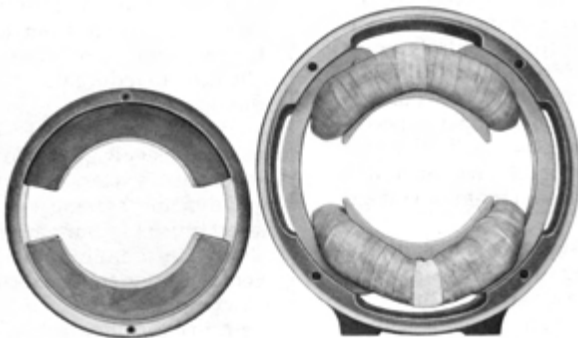

Fig. 3-9: Stators for 1/4 hp (186.5 watt) ventilated shunt-wound field DC motor (right) and 1/4 hp PM DC motor (left). Note that the inner diameters of the two stators are the same, while the outer diameter of the PM motor is considerably smaller.

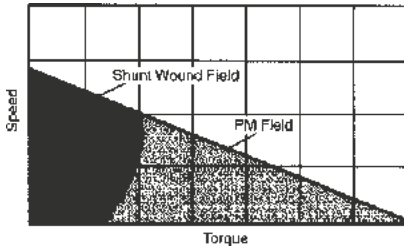

Fig. 3-10: Comparison of shunt and PM motor curve shapes.

permanent magnets. For a given field strength, the PM ring and magnet assembly is considerably smaller in diameter than its wound field counterpart, providing substantial savings in both size and weight. See Fig. 3-9. And since the PM motor is not susceptible to armature reaction, the field strength remains constant.

Armature reaction can act to weaken the magnetic field of a conventional shunt-wound DC motor at loads beyond approximately 200% of rated value. This characteristic is generally responsible for the “drop off” in torque associated with shunt-wound designs. See Fig. 3-10.

If we examine the field construction of the wound field and PM field motors, we can explain the differences in armature reaction and corresponding differences in speed / torque characteristics of the two motor types. The armature magnetizing force in a wound field construction “sees” a very high permeability (low reluctance) iron path to follow. In the PM field design, this armature magnetizing force is resisted by the low permeability (high reluctance) path of the ceramic magnet, which tends to act as a very large air gap. The net result is that the armature cannot react with the field in a PM motor, thereby producing a linear speed / torque characteristic throughout its entire torque range.

PM motors can be useful in a number of specific ways:

a) They produce relatively high torques at low speeds, enabling them to be used

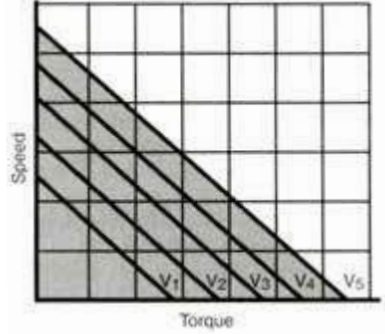

Fig. 3-11: A typical family of speed / torque curves for a PM motor at different voltage inputs, with $V_5 > V_4 > V_3 > V_2 > V_1$.

as substitutes for gearmotors in many instances. PM motors operated at low speeds are especially useful where “backlash” and inherent mechanical “windup” of gearing in gearmotors can not be tolerated.

It should be noted that if PM motors are continuously operated at the high torque levels which they can generate, serious overheating can result.

- b) The linear speed / torque curve of PM motors, coupled with their ability to be easily controlled electronically, make them ideal for adjustable speed and servo motor applications.
- c) The linear output performance characteristics of PM motors also make it easier to mathematically predict their dynamic performance. See Fig. 3-11.

Since the PM field motor is not affected by armature reaction, it can produce very high starting torque. This high starting torque capability can be a valuable asset in many “straight motor” (nongearmotor) applications as well as inertial load applications requiring high starting torque with less running torque. PM motors function well as torque motors for actuator drives and in other intermittent duty applications.

The size reduction in PM motors is generally accomplished without any significant change in the temperature rise rating for a given horsepower. In fact, the electrical efficiency of the PM motor is very often 10% to 15% higher due to the elimination of field copper losses which occur in wound field motors. PM motors can be produced in TENV (totally enclosed non-ventilated) construction, eliminating the need for fans and providing much greater application flexibility.

With their higher inherent efficiency, PM motors offer lower current drain for more efficient battery operation in portable applications. The permanent magnets also provide some self-braking (less shaft coast) when the power supply is removed. PM motors require only two leads (shunt-wound motors require four). The leads can be reversed by simply changing the polarity of the line connection. Dynamic braking is achieved by merely shunting the two leads after disconnecting them from the power source. PM designs also provide similar performance characteristics to shunt-wound DC motors when used with all common control methods (except field weakening). See Chapter 8, Section 8.3.

Disadvantages: While ceramic magnets now have properties which make them very reliable, certain characteristics of these materials must be thoroughly understood if proper operation of ceramic magnet PM motors is to be obtained. At lower temperatures (0°C and below), ceramic magnets become increasingly susceptible to demagnetizing forces.

Armature reaction (which is capable of producing the threshold limit for demagnetization) takes on greater importance at lower temperatures. Therefore, special attention must be given to overload current conditions including “starting,” “locked rotor” and “plug reversing” when applying PM motors to low temperature use. Plug

reversing requires current limiting, even at normal temperatures.

The design of the motor’s power supply is also important. SCR circuits can be designed to provide current regulating and/or limiting features to protect the motor at low temperatures. The actual application parameters involved vary with each particular PM motor design, since the protection against demagnetization is part of the motor’s design and must be considered accordingly. It is best to consult the manufacturer if low temperature use or plug reversing is contemplated.

As operating temperature increases, the residual or working flux of PM motors decreases at a moderate rate. This flux decrease is much like the decrease of field flux strength in wound field motors as copper resistance increases with temperature.

On a motor-to-motor and lot-to-lot basis, PM motors are sometimes criticized for having somewhat greater variability in performance characteristics than wound field designs. Such criticism may be the result of greater variations encountered in both the quality of the raw materials and the processes employed in the manufacture of the magnet segments themselves. However, undue variation can be greatly minimized by the motor manufacturer. Proper magnetic circuit design and calibration of the magnetic assembly to a predetermined common field strength value (somewhat less than full saturation) can do much toward achieving consistent motor performance. Too often, calibration is ignored by some motor manufacturers because of cost, and in many cases, the variation in the level of flux achieved by saturation alone is considered acceptable.

Another concern is whether a PM motor can be disassembled without loss of field strength and without having to provide any additional magnetic circuit keeper. The answer can be yes and no, depending

primarily upon the characteristics of the magnetic materials selected for a given design. Although newer ceramic materials permit disassembly without loss of magnetic field strength, the user should consult the manufacturer before attempting to disassemble the motor.

Cautions: Because of their high starting torque characteristic, care must be exercised in applying PM gearmotors. A PM gearmotor application should be carefully reviewed for any high inertial loads or high starting torque loads. These types of loads could cause the motor to transmit excessive torque to the gearhead and produce output torque which exceeds its design limits. SCR controls having current limiting circuits or overload slip clutches are

often employed to protect gearing used with PM motors.

3.3 BRUSHLESS DC MOTOR ACTION

In Section 3.1 we discussed how motor action is achieved in a conventional DC motor. A segmented commutator rotating within a stationary magnetic field causes mechanical switching of the armature current. In a brushless DC motor, the magnetic field rotates. Commutation occurs electronically by switching the stator current direction at precise intervals in relation to the position of the rotating magnetic field. Solid state controls and internal feedback devices are required to operate brushless DC motors.

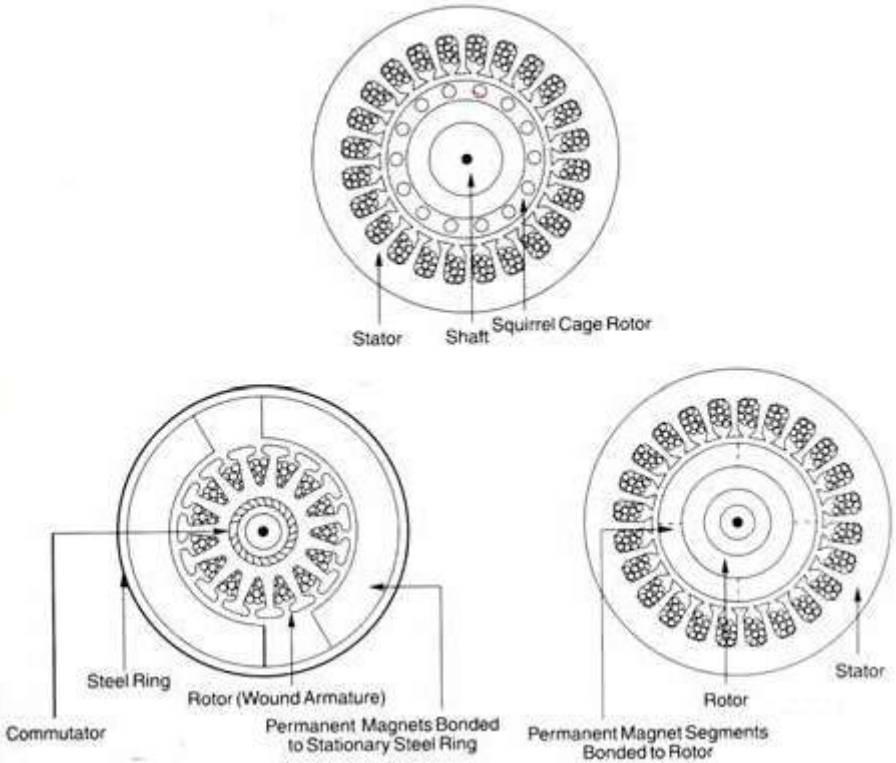

Fig. 3-12: Cross-sections of: a) an AC motor (top), b) a PM DC motor (left), and c) a brushless DC motor (right).

Brushless DC motors combine characteristics of both DC and AC motors. They are similar to AC motors in that a moving magnetic field causes rotor movement or rotation. They are similar to DC motors since they have linear characteristics. Figure 3-12 shows cross-sections of AC, DC and brushless DC motors. The AC motor has windings in the stator assembly and a squirrel cage rotor. The PM DC motor has windings on the rotor assembly and permanent magnets for the stator assembly. The brushless DC motor is a hybrid of the AC and DC motors. The rotor has permanent magnets and the stator has windings.

Brushless DC

Features:

- Continuous duty
- DC power supply
- Reversibility at rest or during rotation with current limiting
- Adjustable speed
- Starting torque 175% and up of rated torque
- High starting current

Design and Operation: Brushless DC motors consist of two parts: the motor and a separate electronic commutator control assembly (see Fig. 3-13).



Fig. 3-13: Brushless DC motor.

The two must be electrically connected with a cable or wiring harness before motor action can take place. See Fig. 3-14.

By energizing specific windings in the stator, based on the position of the rotor, a revolving magnetic field is generated. See Fig. 3-15. Sensors mounted inside the motor detect the position of the permanent magnets on the rotor. For example, as the rotor moves through a specific angle or distance, one of the sensors will detect a change from a north magnetic pole to a south magnetic pole.

At this precise instant, current is switched to the next winding phase. By switching current to the phase windings in a predetermined sequence, the permanent magnets on the rotor attempt to chase the

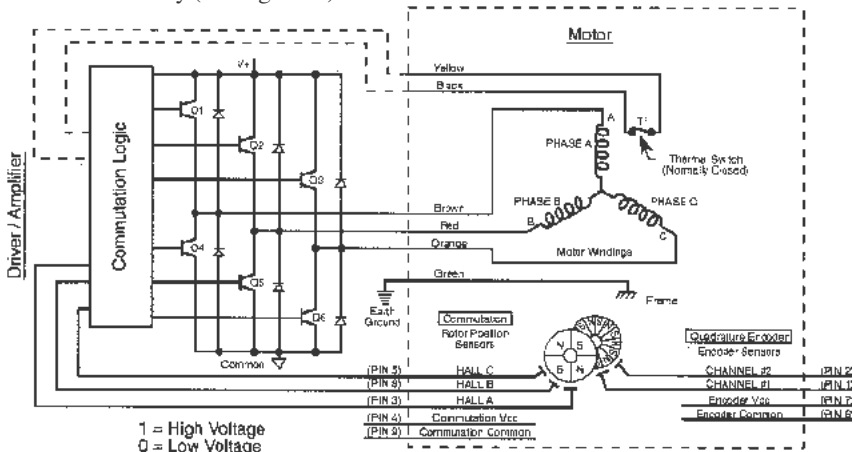

Fig. 3-14: Schematic diagram of a brushless DC motor and control.

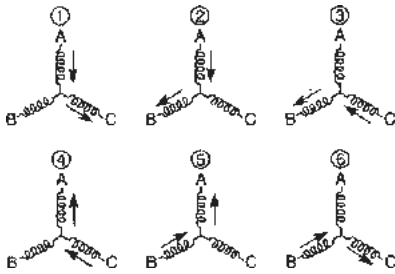

Fig. 3-15: Phase current flow.

current. The current is always switched before the permanent magnets catch up. Therefore, the speed of the motor is directly proportional to the current switching rate. At any instant, two windings are energized at a time with the third one off. This combines the torques of two phases at one time, thus increasing the overall torque output of the motor.

The rotor consists of a four-pole permanent magnet and a smaller four-pole sensor magnet. As the sensor magnet rotates it will activate a series of sensors located 60° apart. The sensors can be photo sensors, Hall effect devices, magneto resistors or other devices which monitor the

position of the shaft and provide that information to the controller.

The controller logic circuits contain a binary decoder which interprets the signals from the sensors regarding the position of the permanent magnet rotor. The logic circuit outputs a specific address which tells a drive circuit (Q_1 through Q_6 in Fig. 3-14) which windings should be energized.

The rotation of the motor is changed within the control logic which in turn reverses the phase energizing sequence. A toggle switch is usually provided to convert the logic from clockwise to counterclockwise. Figure 3-16 shows the truth tables for both clockwise and counterclockwise commutation.

Trapezoidal vs. Sinusoidal Torque Properties: Timing of the "on" and "off" switching of different phase pairs is determined by the signals emanating from the sensors in the motor's commutation circuitry.

Trapezoidal torque characteristics of the phase pairs mean that fewer commutation signals are required than for a motor whose phases exhibit sinusoidal torque properties. This simplifies the control design and minimizes its cost, while providing a motor torque output with low ripple properties.

Commutation circuitry is designed to switch as the torque output and the back emf in the individual phase pairs reach their maximum (and most constant) level. This produces the least ripple effect on the output torque and the lowest phase current swing. The resulting smooth output torque makes it easier to implement digital and pulse width modulation control techniques.

Advantages: Brushless motors are more reliable. They do not have commutator or brushes to wear out. The commutation is achieved through reliable solid-state circuit components, making them ideal for applications where downtime is critical or where drive system access is difficult.

Hall Sensor Output			Switches On		Phase Current		
A	B	C	Q1	Q5	A	B	C
0	0	1	Q1	Q5	+	OFF	-
0	0	0	Q1	Q5	+	-	OFF
1	0	0	Q3	Q5	OFF	-	+
1	1	0	Q3	Q4	-	OFF	+
1	1	1	Q2	Q4	-	+	OFF
0	1	1	Q2	Q6	OFF	+	-

CW from Back End*

a

Hall Sensor Output			Switches On		Phase Current		
A	B	C	Q3	Q5	A	B	C
0	1	1	Q3	Q5	OFF	-	+
1	1	1	Q1	Q5	+	-	OFF
1	1	0	Q1	Q6	+	OFF	-
1	0	0	Q2	Q6	OFF	+	-
0	0	0	Q2	Q4	-	+	OFF
0	0	1	Q3	Q4	-	OFF	+

CCW from Back End.*
 1 = High Voltage
 0 = Low Voltage

b

Fig. 3-16: Commutation sequence: a) clockwise (top), and b) counterclockwise (bottom).

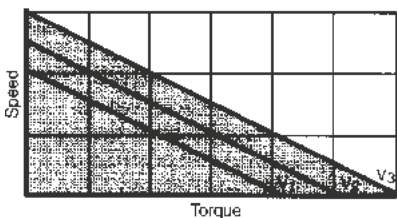

Fig. 3-17: Typical speed / torque curve for a brushless DC motor.

Brush sparking and associated RFI are eliminated.

Brushless motors are not sensitive to harmonics like AC motors. The brush noise associated with brush-type DC motors and commutators is also eliminated.

Brushless DC motors provide predictable performance because of their linear characteristics. See Fig. 3-17. They can exhibit high starting torques, precise positioning capability and controlled acceleration and deceleration. And more power can be achieved from a smaller size motor.

Brushless motors can be designed with low rotor inertia. This means they accelerate more quickly in less time and offer less power dissipation during the stop / start cycle. They are also capable of operating at high speeds since there are no mechanical commutator limitations.

Disadvantages: Unlike conventional DC motors, electronically commutated designs cannot be reversed by simply reversing the polarity of the power source. Instead, the order in which the current is fed to the field coil must be reversed. Also, due to low friction inherent in brushless motors, excessive coasting may be a problem after the current has been removed. Special damping circuits or other devices may be added to remedy this factor, but cost will be adversely affected.

From a cost standpoint, the electronics needed to operate brushless DC motors are relatively more complex and therefore more expensive than those used with con-

ventional DC motors. While electronically commutated DC motors are now closer to being competitive with conventional DC / tachometer feedback units, they are still costly when compared with conventional DC / SCR control drives.

Stepper Motors

Features:

- Continuous duty
- DC power supply
- Reversibility at rest or during rotation
- Adjustable speed
- Normal starting current

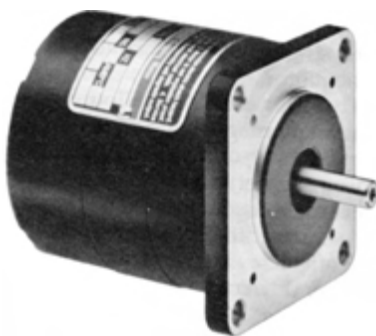

Fig. 3-18: Stepper motor.

Design and Operation: The widespread acceptance of digital control for machine and process functions has generated a growing demand for devices that translate digital commands into discrete incremental motions of known accuracy. The ability to interface stepping motors with microprocessors and / or mini-computer controls has enhanced their application potential (see Fig. 3-18).

While conventional AC and DC motors operate from continuously applied input voltages and usually produce a continuous (steady state) rotary motion, stepper motors move in discrete steps (increments). Stepping occurs in strict accordance with the digital input commands provided. At

very low stepping rates, the stepping action at the motor shaft may be visible. At high stepping rates, the shaft appears to rotate smoothly, like a conventional motor. Step error is noncumulative. The absolute position error is independent of the number of steps taken. Final shaft position is predictable within a maximum error determined by mechanical tolerances, and from the motor's static torque vs. angular displacement curve.

Although we refer to the angular position of the stepper shaft as the motor's "output," there are many applications where this rotation is converted to precise linear motion, for example, by means of the lead screw or rack and pinion.

DC steppers are divided into three principle types, each having its own unique construction and performance characteristics:

- 1) variable reluctance (VR),
- 2) permanent magnet (PM), and
- 3) PM hybrid.

Variable Reluctance: Generally a lower priced drive, the variable reluctance stepper has a wound stator and a multi-poled soft iron rotor. The step angle (determined by the number of stator and rotor teeth) varies typically from 5 to 15 degrees. Unlike the hybrid design, variable reluctance steppers have relatively low torque and inertia load capacity. They are, however, reasonably inexpensive and adequate for light load computer peripheral applications. Operating pulse rates vary over a wide range, depending upon the specific design and construction of a particular motor.

PM Steppers: With step angles ranging from 5 to 90 degrees, PM steppers are low to medium-priced units with typically slower step rates (100 steps / second for larger units and 350 steps / second for smaller ones). They usually employ a

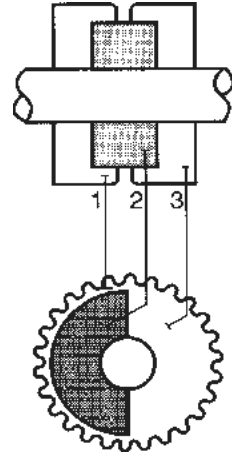

Fig. 3-19: 1) Hollow laminations, 2) Alnico permanent magnet, and 3) solid laminations.

wound stator with a PM rotor delivering low torque. Step accuracy is $\geq \pm 10\%$.

PM Hybrid: The PM hybrid stepper combines the construction and performance aspects of both PM and variable reluctance type stepper motors. Both the rotor and wound stator are toothed. The toothed rotor is composed of one or more elements known as stacks. See Fig. 3-19. Each stack has both hollow and solid laminations bonded together to form two cup-shaped structures. A permanent magnet is inserted in the space between the two cups. Rotor stacks are then fastened to a nonmagnetic (usually stainless steel) shaft.

The perimeter of each lamination has multiple teeth with a specific tooth pitch (angle between tooth centers) depending on the degree of step required. Step angles vary from 0.5 to 15 degrees. See Fig. 3-20.



Fig. 3-20: PM hybrid stepper tooth pitch.

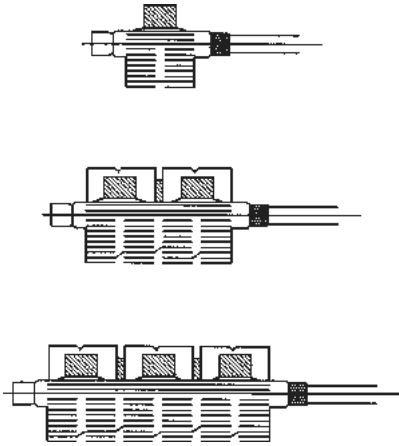

Fig. 3-21: Variable stack lengths for PM hybrid stepper motors.

When the cups are pressed on the shaft to form a stack, they are positioned in such a way that the teeth of one cup line up with the slots of the other cup. The two cups of each stack are said to be offset from each other by half of one tooth pitch.

The stack configurations can vary. When more than one stack is used, non-magnetic spacers are inserted between stacks to prevent coupling. See Fig. 3-21.

Without the spacer, the separate magnetic structures would combine, eliminating the advantage of multiple stacks. With adequate space between them, magnetic flux will follow the path of least resistance through the stator core, multiplying the available torque by the number of stacks. This construction gives the PM hybrid higher torque capacity (50 to 2000 + oz-in.) with step accuracies to $\pm 3\%$. See Fig. 3-22.

Figure 3-23 shows a cross-section of a typical DC PM hybrid stepper with toothed rotor and stator. When the rotor is inserted into the stator bore, only one pair of stator poles will line up exactly, tooth-for-tooth, with the teeth on a single rotor cup. The remaining poles will be out of alignment by some fraction of a tooth pitch. This misalignment is what makes it possible for a stepper to develop torque. Most PM hybrid steppers have four phases which are bifilar wound, but other phase arrangements and multiples are available.

When phases are energized in a specific sequence, PM hybrid steppers deliver specific angular output motions (steps) of known accuracy, provided that system

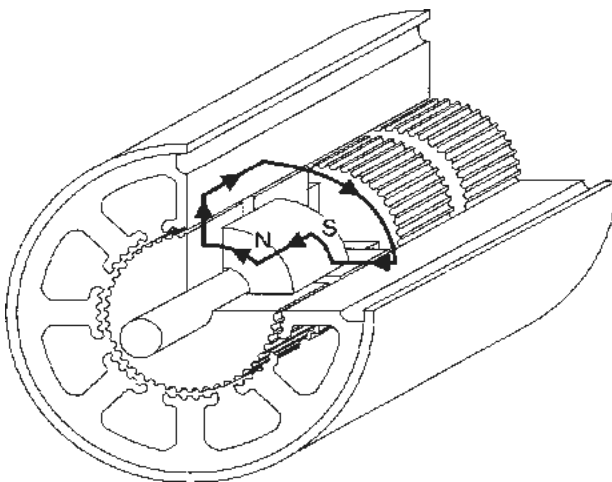

Fig. 3-22: Flux path through rotor and stator.

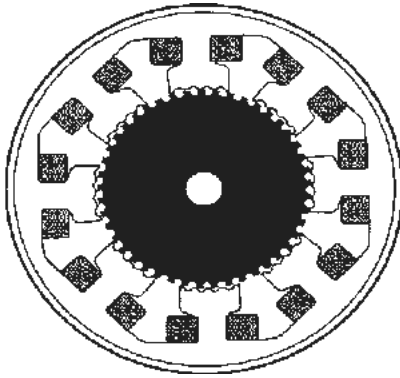

Fig. 3-23: Cross-section of a typical DC PM hybrid stepper with toothed rotor and stator.

inertia and friction do not exceed acceptable limits.

Each angular displacement ends in a well-defined position of magnetic attraction called a detent position. These stable equilibrium positions are created by the magnetic interaction between the permanent magnet rotor and the magnetic field produced by the energized phase windings. As the motor is stepped, the detent positions shift around the entire 360° rotation. The direction of rotation is determined by the phase energization sequence.

PM hybrid designs offer excellent speed capability—1000 steps / second and higher can be achieved. Because the step angle is fixed by the tooth geometry and step error is noncumulative, the shaft position of a motor loaded within its capacity is always known within a fraction of one step. This open-loop operation eliminates the need for encoders, tachometers and other feedback devices which add to system cost.

Advantages: Steppers are popular because they can be used in an open-loop mode while still offering many of the desirable features of an expensive feedback system. Hunting and instabilities caused by feedback loop sensitivity and phase shifts are avoided.

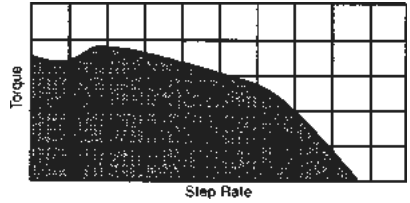
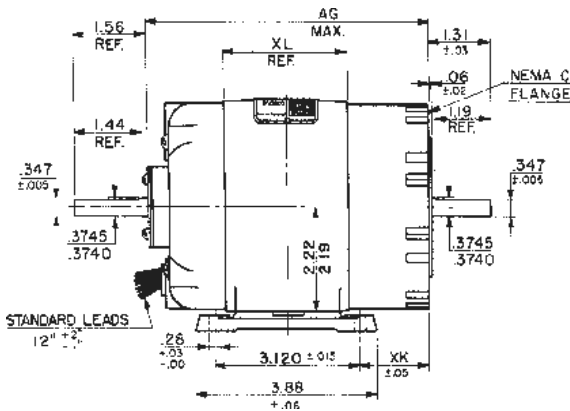

Fig. 3-24: Typical torque vs. speed (steps / second) for a PM hybrid stepper.

Due to the noncumulative nature of stepper error, step motors also offer improved accuracy. The replacement of less dependable mechanical devices, such as clutches and brakes, with step motors provides considerably greater reliability and consistency. Predictable and consistent performance coupled with reasonable cost make the DC stepper an excellent positioning drive.

Disadvantages: Stepper motors can be made to produce reasonably high torques (2000 oz-in. or more). However, they do have a limited ability to handle extremely large inertial loads. See Fig. 3-24. Since steppers tend to oscillate (ring) upon stopping, some sort of damping means is usually required. Stepper motors unfortunately are also not very energy efficient, but this is the price that must be paid to achieve the truly unique performance characteristics available from the stepper motor. Resonance is sometimes a problem that can be remedied by a specialized electronic control design or by avoiding operation within the step rate ranges prone to resonance. Refer to Chapter 8, Section 8.5. Most stepping motors are fixed angle devices (although half angle stepping can be achieved electronically).



Special Purpose Motors

In Chapters 2 and 3 we discussed the electrical characteristics of AC and DC motors and the basic methods of achieving motor action with either AC or DC power. From this, we determined that each type of motor offers certain advantages or disadvantages when applied to an application. In some cases, there is a considerable degree of performance overlap from one motor to the next, leaving cost as a criteria for motor selection.

Most applications, if studied carefully, will have parameters that will be satisfied more effectively by one type of motor. There are other criteria such as continuous operation at very slow speeds, short duty cycles or high torque requirements within a limited mounting space, to name just a few, that can place very unusual demands on fractional horsepower motors.

To meet these unique design criteria, motor manufacturers have developed a variety of special purpose motors that exceed the specifications of many common motor designs. In this Chapter we will take a brief look at some of these special purpose motors.

4.1 FRACTIONAL HORSEPOWER GEARMOTORS

For low speed drive applications, electric motor manufacturers have developed compact and efficient integral gearheads. When coupled with common fractional horsepower (fhp) electric motors, these gearheads provide speed-reducing/torque-multiplying units of exceptional reliability. In any application which requires shaft speeds slower than that of a "straight" motor, fhp gearmotors can be a highly desirable alternative to conventional belts, gears and chains.

Garmotors free the original equipment manufacturer of the burden of designing external reduction devices. They also offer original equipment designers a highly-engineered, field-tested, single-source drive system.

Because gearmotors are rated and selected based on both the motor specifications and the gearhead specifications, they present a unique situation. Therefore, gearhead design and operation will be discussed in

greater detail in Chapter 6 and the application and selection of gearmotors will be discussed in Chapter 7.

4.2 LOW SPEED AC SYNCHRONOUS MOTORS

Some applications require high torque combined with rapid stop and start characteristics. Low speed AC synchronous motors are appropriate for applications which require six or more starts per minute. Since the motor has no significant current rise on starting, there is no additional heat rise with repeated starts.

Unlike gearmotors, there is no backlash associated with low speed synchronous motors. As a result, they are used in place of gearmotors in some applications. Most low speed synchronous motors are designed to start typically within 1.5 cycles of the applied frequency. Most low speed

synchronous motors will reach full synchronous speed within 5 to 30 milliseconds. See Fig. 4-1.

Because of their rapid start characteristics, careful attention must be given to inertial loads especially if the load is to be coupled directly to the motor shaft. As inertia is increased beyond a certain value, the available torque decreases. This inertia is defined by the “knee” in the torque vs. inertia curve shown in Fig. 4-2. Also, operation with less than minimum inertia can sometimes result in objectionable start-up noise or reduced available torque. The use of gearing can increase the ability of these motors to move inertial loads. Speed change gearing produces reflected load inertia in proportion to the square of the gear ratio. For example, a 2 to 1 reduction from 72 RPM at the motor to 36 RPM at the load reduces reflected inertia 4 to 1, and conversely, an increase of speed at the load to 144 RPM increases reflected inertia 4 to 1.

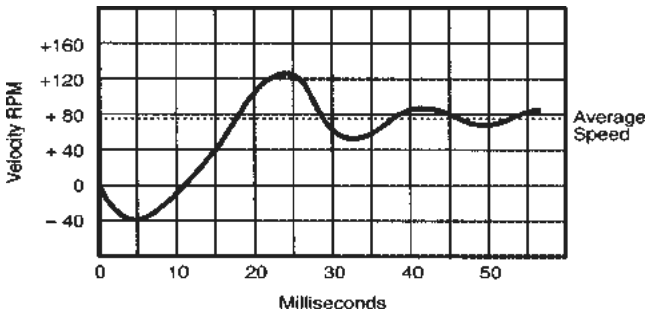

Fig. 4-1: Typical starting characteristics for a low speed AC synchronous motor.

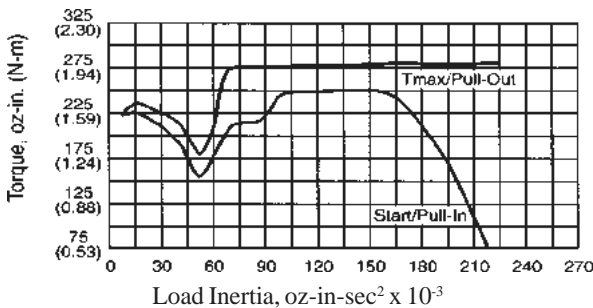

Fig. 4-2: Typical torque vs. inertia curves for a low speed synchronous motor.

Resilient couplings can be used in applications with high inertial loads to provide some free shaft rotation so the motor can start the load. A resilient coupling should provide approximately five degrees of rotational freedom before full load is applied. Standard coupling means include rubber components, timing belts and slack chains. On the other hand, adding a resilient coupling in an application, with less than the minimum rated system inertia connected to the motor, may reduce the available torque.

Low speed synchronous motors can usually withstand stalls without overheating since the starting, full load and no-load currents are essentially the same. However, the motor will vibrate in prolonged stalled conditions against a solid stop, which could cause bearing damage over a period of time. The stall torque cannot be measured in the conventional manner, because there is no average torque delivered when the rotor is not in synchronization with the apparent rotation of the stator magnetic field.

Low speed AC synchronous motors decelerate faster than conventional motors, usually stopping within a range of 5° to 15° after turn-off with no external inertia, depending on the RPM rating of the motor. Application of DC to one or both motor windings after removal of AC can produce deceleration times one-tenth to one-twentieth of those attainable with a conventional motor. The motor position remains electrically locked after stopping.

4.3 TORQUE MOTORS

Torque motors are a variation on conventional induction and DC type motors. They are designed for duty in slow speed and tensioning applications. Not only will they deliver maximum torque under stalled or “locked rotor” conditions, but torque machines can maintain a “stall” for

prolonged periods, allowing for the controlled tension essential in such applications as spooling and tape drives.

Torque motors are especially useful in three general classes of operation:

- 1) **Motor stalled with no rotation required.** Torque motors will operate like a spring in applications which require tension or pressure. They can be easily controlled to change the amount and direction of force applied.
- 2) **Motor shaft to rotate only a few degrees or a few revolutions to perform its function.** Torque motors may be used to open or close a switch, valve or clamping device. In this sense, they are used as “actuators.”
- 3) **The shaft must rotate a major portion or all of the cycle at a speed much lower than that of a conventional motor.** Spooling and reel drives may require torque motor characteristics. Reel drives may also call for slow speeds during the “playback” mode, and higher speeds for short periods in a rewind or “searching” phase.

AC torque motors are normally of the permanent split capacitor (PSC) or polyphase induction type. See Fig. 4-3. Brush-type motors may also be designed to operate as torque motors. This would include shunt and permanent magnet



Fig. 4-3: Typical AC torque motor.

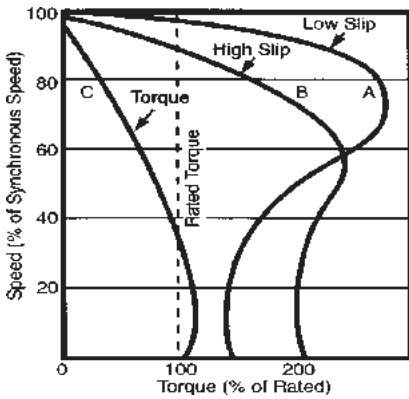

Fig. 4-4: Torque motor design vs. high and low slip motor design

designs which run on DC as well as series wound torque motors capable of running on either AC or DC supplies.

Torque motor characteristics are usually obtained by “deviating” from conventional stator winding, rotor winding (squirrel cage), rotor lamination and air gap designs. Figure 4-4 shows the substantially different speed / torque curves achieved in one basic motor design (frame) by changing one or more of the above-mentioned design parameters.

Curve A is a motor designed for low slip, high output running performance and a high breakdown of torque. By changing one parameter, we can get performance characteristics indicated by curve B. By making additional parameter changes, we can obtain the characteristics shown in curve C, which is very nearly a straight line (curve C approaches the “ideal” for torque motor service).

Because there is a reduction in the power input, giving the motor prolonged stall capability, the locked rotor torque in curve C must be lower than that in the other two curves. It is common practice to operate torque motors at different levels of power input in applications which have wide variations in torque demand.

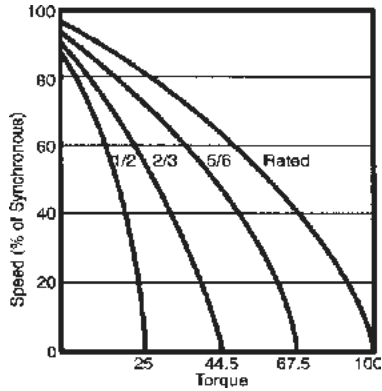

Fig. 4-5: Family of speed / torque curves for various input voltages

.For example, in tape reel drives, high speed is needed for fast rewind while relatively low speeds are required for recording and playback.

Reduced output is usually obtained by reducing the voltage applied to the motor. This may be accomplished by a variable ratio transformer, saturable reactor, silicon controlled rectifier (SCR) supply, or in the case of small motors, by a series resistor. The output of a torque motor will be affected by voltage change in the same way as conventional motors — by the square of the voltage, as shown in Fig. 4-5. While the curves in Fig. 4-5 are for a voltage reduction across the entire motor winding, it is sometimes advisable to reduce only the voltage across the main winding of a PSC motor. This keeps the full line voltage on the capacitor and capacitor winding combination so that torque stability at extremely low operating speeds can be maintained. When connected in this manner, the torque can be varied approximately in proportion to voltage.

Many torque applications require that the motor be driven against the normal rotation of its rotating field during a portion of each cycle. The reverse rotation (resisting) torque is normally never greater than

stalled torque and will decrease slightly as the reverse speed increases from zero.

A typical tape reel application can be used to demonstrate this requirement. When a tape is being wound from one reel to another, resisting torque is necessary on one reel motor to provide tape tension. The voltage is reduced on the motor that resists being pulled against its normal rotation to provide the desired tension on the tape.

There are several specific differences in rating concepts between conventional induction motors and their torque motor counterparts. An understanding of these differences is essential for proper application. In contrast to ordinary induction motors, torque motor input and output are considered at locked rotor rather than operating speed. While output is normally expressed as horsepower or watts, torque motor output is described as torque (ounce-inches, ounce-feet, pound-feet or newton-meters).

The speed rating of a torque motor is either its “no-load” speed or the theoretical synchronous speed if the motor is an induction type.

Duty cycle ratings of torque motors are also important, and should include two factors:

- 1) the percentage of the duty cycle during which the motor may be “stalled” at rated voltage, and
- 2) the maximum time duration of the stall.

For example, if a motor has a 40% duty and 30 minute time rating, the motor can be stalled for 40% of the entire duty cycle, and the continuous stalled time cannot exceed 30 minutes out of a 75 minute duty cycle.

During the remaining 45 minutes, the motor must be de-energized to permit the heat generated during the stalled period to dissipate.

Of course, the duty cycle of this motor could have many other variations. If the stalled time was only three minutes, the total cycle could be as short as 7.5 minutes (the motor will be de-energized for 4.5 minutes). A motor designed with a torque sufficiently low to permit continuous stall, and not exceed the maximum acceptable temperature, would be rated 100% duty and a time rating would be unnecessary.

In general, the best torque-to-watt ratio is obtained in low speed induction motors (six or more poles). The relationship of motor poles to torque and speed is shown in Fig. 4-6. Having no commutator or brushes, induction motors are rugged and require a minimum of service. The permanent split capacitor (PSC) motor is by far the most popular in fractional and subfractional sizes. It operates on single-phase AC and has a torque-output-to-watt input ratio that compares favorably with the polyphase motor under locked rotor conditions.

Another advantage of the PSC motor as a torque motor is that it can be designed with a three-wire reversible winding which will permit it to be stopped, started and reversed by a simple single pole / double throw switch. The shaded pole design may satisfy some torque motor applications, but its torque-to-watt ratio is low, and it

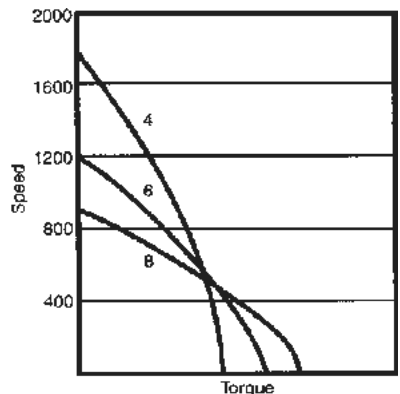

Fig. 4-6: Speed vs. torque for various numbers of stator poles.

cannot be reversed.

While the output of a torque motor is usually taken from the rotor shaft directly, the motor may have a speed reducing gearhead through which the torque is increased by the mechanical advantage of the ratio minus the losses in gearing. When a gearmotor is being considered, the gearing type and ratio are very important and must be chosen with care. This is especially true if part of the motor's function requires it to be driven by the load, or if the operation requires the motor and load to be brought to rest by bumping a rigid stop. The mechanical parts in a gearhead must be able to withstand the shocks and stresses imposed by the application.

Since the torque motor operates either under a stalled condition or at speeds too low to provide self-ventilation, it is important that a motor with a maximum torque-to-watt ratio be used that will also satisfy all of the other requirements of the application. If the operating temperature of the torque motor chosen for an application exceeds safe limits, and there is no available space to accommodate a larger motor, the problem may be overcome by providing additional cooling with a low cost, motor-blower unit. The use of the smaller torque motor (with the blower addition) may even result in a cost savings over the use of a larger motor.

A "fail-safe" brake may also be used to reduce temperature in torque motor applications. This would be applicable in cases where the motor must lift a load to a specific location and hold it for an extended period. The brake, connected in parallel with the motor, would be applied by spring pressure when power is removed from the motor. This action will keep the load in position without any heat being generated

Cautions: From the above discussion it is apparent that most torque motor applications require the use of a sample

motor for tests in the machine before determining final specifications for the optimum motor. Answers to the nine questions below should give the motor manufacturer enough information to supply a sample that is close to "ideal." The customer could then adjust the voltage to the sample to obtain the desired performance with minimum input power. Temperature tests should also be performed in the equipment under actual or simulated duty conditions. Consultation with the motor manufacturer should determine whether modifications or resizing will be necessary.

Criteria for determining torque motor applications are:

- 1) What is the available power (voltage, AC or DC, phase and frequency)?
- 2) What is the torque requirement and duty cycle?
- 3) What are the minimum and maximum speeds and how long will the motor operate at the various speeds?
- 4) Will the motor be driven by the load at any time in the cycle?
- 5) Is a brake or clutch to be used in the drive mechanism?
- 6) Will the motor and load be brought to rest by bumping a rigid stop?
- 7) What mounting space is available?
- 8) Is surrounding air free of dust and contaminants or should the motor be enclosed to protect against pollutants?
- 9) What is the ambient temperature?

4.4 SWITCHED RELUCTANCE MOTORS

The switched reluctance motor is a type of synchronous reluctance motor. The stator and rotor resemble that of a variable reluctance step motors. See Fig. 4-7.

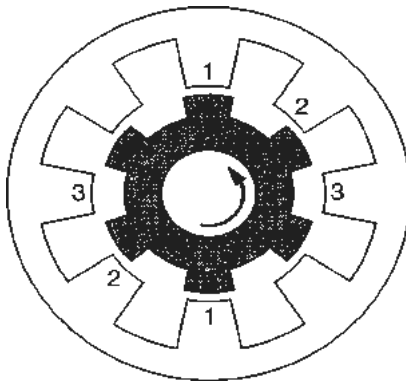

Fig. 4-7: Typical switched reluctance motor design.

The stator of a switched reluctance motor may have three or four phases as does the step motor. There are no coils on the rotor which eliminates the need for slip rings, commutators and brushes. Both the stator and the rotor of a switched reluctance motor have salient poles.

The rotor is aligned when the diametrically opposed stator poles are energized. Two of the rotor poles will align to the stator poles. The other rotor poles will be out of alignment with the remaining stator poles. When the next stator pole pair is energized in sequence, they attract the two rotor poles that are out of alignment. By sequentially switching the current from one stator winding to the next, the rotor continually rotates in a kind of “catch-up” mode trying to align itself with the appropriate minimum reluctance position of the energized stator windings — thus the term, “switched reluctance.”

The switched reluctance motor provides inherent characteristics and control functions that are directly equivalent to DC servo motors. The torque of the switched reluctance motor is equal to the square of the current giving it excellent starting torque. Motor direction can be reversed by changing the current switching sequence in the stator windings. Like their DC coun-

terparts, the brushless design of switched reluctance motors simplifies maintenance.

Switched reluctance motors cannot be operated directly from a three-phase AC supply or a DC source. They require a controller which adds to their cost. They are also capable of four quadrant operation, that is, both speed and torque are controllable in both negative and positive directions. For more information on motor control, refer to Chapter 8.

Switched reluctance motors can achieve very high speeds which may be limited only by the type of bearings used. This makes them ideal for high speed applications. Ironically, their high speed operation causes considerable noise which is one of their disadvantages.

4.5 LINEAR INDUCTION MOTORS

Conventional rotary motors require some type of rotary-to-linear mechanical converter (lead screw, rack and pinion, etc.) if they are used in applications where the final stage results in linear motion. The most obvious advantage of linear induction motors (LIMs) is that they produce linear motion directly without the need of a transmission or conversion stage.

The operation of linear induction motors can be more easily understood if we start with a conventional rotary squirrel cage motor, cut the stator and rotor along a radial plane and roll them out flat. See Fig. 4-8. The rotor equivalent of the linear motor is called the secondary and the stator equivalent is called the primary.

Figure 4-9 shows that the primary consists of a core and windings (multiple phases) which carry current and produce a sweeping magnetic field along the length of

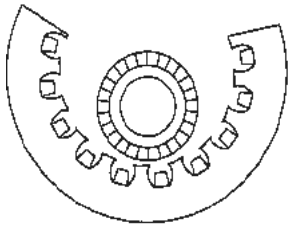

Partially Unrolled

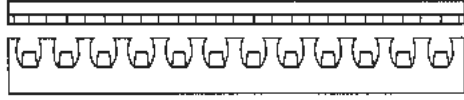

Completely Unrolled

Fig. 4-8: Basic linear motor construction

the motor. The secondary can be a sheet, plate or other metallic substance. Linear motors can have single or dual primaries. The sweeping action induces currents in the secondary and thus creates thrust in a given direction depending on the direction of current flow.

In contrast to a rotary motor, either element can be the moving element in a linear motor. LIMs can have a fixed primary and moving secondary or vice versa. This adds to their flexibility in a wide range of applications. The secondary and primary are separated by a small air gap, typically 0.015 to 0.045 inches. This gap is maintained by using bearings, wheels or magnetic levitation.

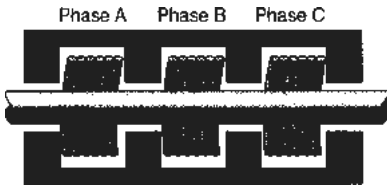

Fig. 4-10: Tubular or round rod LIM.

The flat primary can be rolled in the transverse direction creating a cylinder into which a tube or rod-type secondary can be inserted. See Fig. 4-10. This is referred to as a tubular or round rod linear motor.

An advantage of this type of linear motor is that it has no end connections and can be operated either horizontally or vertically.

One of the factors that determines LIM performance is the pitch-to-gap ratio of the primary coils. It affects the input power delivered to the secondary and the harmonic content of the sweeping magnetic flux. In general, a larger ratio translates into better performance since it means less harmonics. Flat LIMs are usually more efficient than tubular LIMs.

The maximum speed of a LIM is directly proportional to the operating frequency and the pitch-to-gap ratio. Speed is varied by using a variable frequency controller.

LIMs are ideal for applications such as computer plotters and read head positioning units, drapery openers, X-ray camera positioning and a wide variety of conveyor applications.

4.6 DC AND AC SERVO MOTORS

Servo motors are available in both DC and AC types. Servo motors are an integral part of a closed-loop feedback control system consisting of the motor, an amplifier

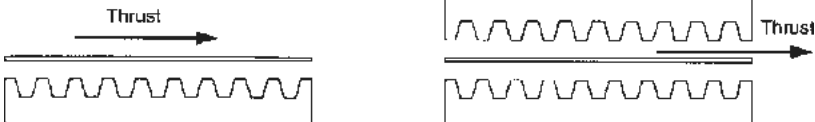

Fig. 4-9: Thrust developed by single (left) and dual (right) primary linear motors.

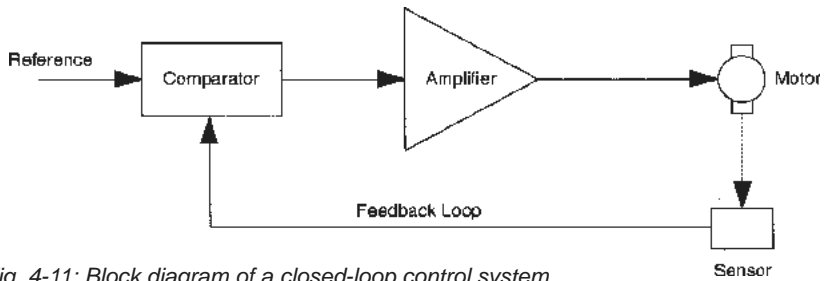

Fig. 4-11: Block diagram of a closed-loop control system.

which drives the motor, an actuator and a feedback device.

A block diagram for a closed-loop system using a servo motor is shown in Fig. 4-11. Any change in a system's load, amplifier gain or other variable will cause the output of the system to deviate from the expected response. In the closed-loop system, these variations in output are monitored, fed back and compared to a reference or desired input. The difference between the reference and the measured output signal is a deviation. The deviation is amplified and used to correct the error. Therefore, the closed-loop system is self-correcting. For more information on motion control systems, see Chapter 8.

Although servo motors show the basic performance characteristics of the motor classes to which they belong (AC induction, PM DC, etc.), they incorporate special design features which make them uniquely suited to applications involving feedback control. Because servo motors must be sensitive to a relatively small control signal, their designs stress reaction to small voltage variations, especially at starting.

Both DC and AC servo motors possess two fundamental characteristics:

- 1) the output torque of the motor is roughly proportional to the applied control voltage (which the drive amplifier develops in response to an error signal), and
- 2) the instantaneous polarity of the control voltage determines the torque direction.

AC servo motors are used in the 1/1500 to 1/8 hp ranges. Beyond this range AC motors become very inefficient and difficult to cool. DC servo motors are usually used in higher hp ranges.

Direct-Drive Servo Motors:

In applications where precise positioning and speed control is required, a direct-drive servo motor is often employed. Direct-drive servo motors allow the load to be directly coupled to the motor which eliminates backlash and wear associated with other coupling arrangements. Direct-drive servo motors are capable of achieving fast acceleration and have excellent response times.

Direct-drive servo motors are usually brushless and provide all of the advantages of brushless technology. They may also have built-in resolvers which provide precise position monitoring and feedback control. Position accuracy in the range of 30 arc seconds is typical. For more information on feedback devices, refer to Chapter 9.

4.7 SHELL-TYPE ARMATURE MOTOR

While hardly a new idea (patents were granted for shell-type armature designs near the turn of the century), shell-type armature motors have benefited tremendously from advances in polymer resin technology. While early armatures were

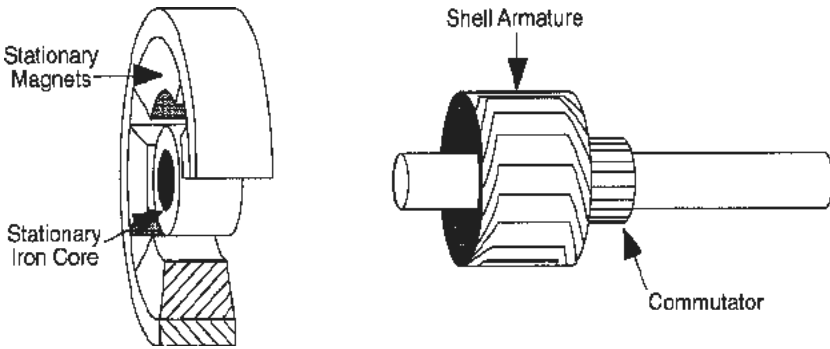

Fig. 4-12: Basic construction of a shell-type armature motor.

bonded with metal strapping (which contributed to large eddy current losses), more recent shell-type designs make use of a variety of bonding methods which do not contribute significantly to motor inertia. These innovations have combined to produce motors with extremely low inertia and high acceleration — characteristics which are useful in many servo applications.

Shell-type armature motors operate in much the same way as conventional permanent magnet motors, with an oriented PM field and commutation by spring-loaded brushes. The feature that makes shell armature motors unique is the hollow cylindrical armature composed of a series of aluminum or copper coils (“skeins”) bonded together in polymer resin and fiberglass to form a rigid, “ironless,” shell. See Fig. 4-12. Because the armature has no iron core, it has very low inertia and rotates in an air gap with very high flux density.

The unusual design characteristics of the shell-type armature motor contribute to low inductance and low electrical time constant (less than 0.1 millisecond). The absence of rotating iron in the shell-type armature motor results in a very high torque-to-inertia ratio, producing high acceleration and quick response required in many positioning servo and incremental motion applications. Figure 4-13 shows the typical speed / torque curves for a shell-type armature motor.

The principal disadvantage to shell-type armature designs is their thermal time constant (typically 20-30 seconds for armature, and 30-60 minutes for housing). Without proper cooling and/or sophisticated control circuitry, the armature could be heated without warning to destructive temperatures in a matter of seconds during an overload condition.

Another difficulty is the tendency for shell-type motors to exhibit audio noise and output shaft “whip” at high speeds. Like printed circuit motors, shell-type armature motors are of somewhat fragile construction and should be operated in a more or less controlled environment. Furthermore, due to the manufacturing techniques and degree of application engineering required for this type of motor, they are relatively expensive and tend to be employed only where their unique performance characteristics are required.

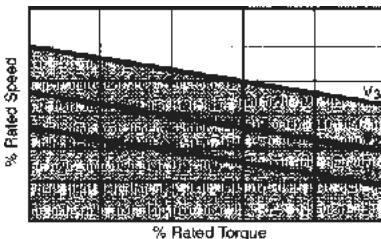

Fig. 4-13: Typical speed / torque curves for a shell-type armature motor.

4.8 PRINTED CIRCUIT (PC) MOTOR

Like the shell armature motor, printed circuit (PC) motors were developed in response to the need for low inertia, high acceleration drives for actuators and servo applications. The ironless armature is again a feature, this time in the form of a compact disc-shaped coil operated in conjunction with a PM field.

The essential element of the PC motor is its unique disc-shaped armature with stamped and laminated or “printed” commutator bars. See Fig. 4-14. This nonferrous laminated disc is composed of copper stampings sandwiched between epoxy glass insulating layers and fastened to an axial shaft. Field flux in a printed circuit motor is provided by either multiple or ring-type ceramic permanent magnets, with

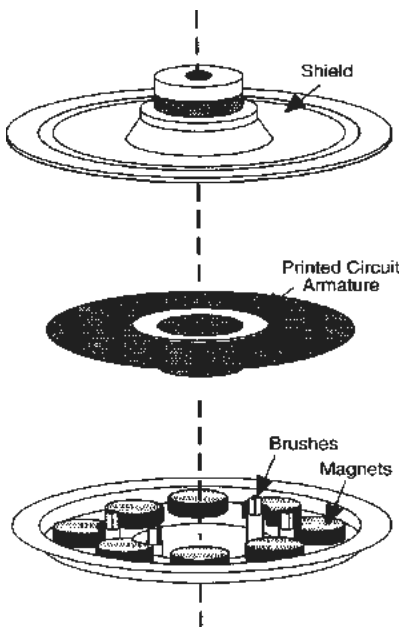

Fig. 4-14: Basic stator and armature construction of a printed circuit (PC) motor.

a flux return plate to complete the magnetic circuit. The corresponding condensation of field and armature assemblies gives the PC motor a somewhat unique “pancake” shape.

The PC motor armature contains no wound windings, and spring-loaded brushes ride directly on the stamped or printed conductors (sometimes referred to as face-commutation). This design variation provides relatively low torque ripple (fluctuation in motor torque) and rapid acceleration useful in many servo applications.

The combination of low inertia armature and resultant high acceleration makes the printed circuit design a suitable drive in some intermittent duty applications (positioning servos) where smoothness of torque is an advantage, and in velocity servo applications where speed control within a single revolution is a factor. See Fig. 4-15.

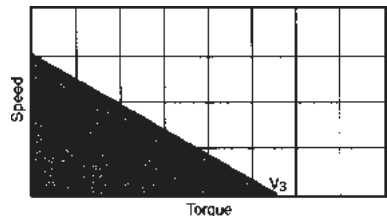
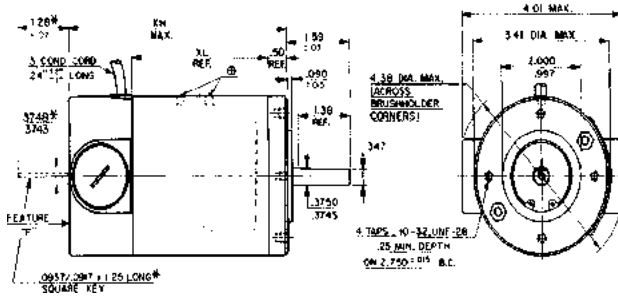

Fig. 4-15: Typical speed / torque curves for a printed circuit motor.

Since the current flow in a disc armature is radial, the “windings” are arranged across a rather large radius. This radius factor (moment of inertia of a disc increases by the fourth power of disc radius) contributes substantially to the moment of inertia of the armature. In addition, the relatively fragile construction of the thin PC armature usually limits its application to controlled application conditions associated with data processing and other sensitive systems equipment.



Basic Motor Construction

Electric motor design involves complex calculations that take into account the physical laws of magnetism and numerous empirical factors in order to arrive at an optimal combination of materials for use in motor construction. A given motor design is expected to deliver a range of specified output torques and speeds while operating within various physical, environmental and cost constraints. Since the output of the motor is determined by the characteristics of its magnetic circuits, the magnetic materials used in its construction are of primary importance.

5.1 MAGNETIC MATERIALS AND MOTOR DESIGN

Electric machines are designed to convert electrical energy into mechanical energy to perform work. The force necessary to do this work is typically derived from two or more magnetic fields set in opposition to each other. The strength of these

opposing fields relative to each other determines the turning force or torque produced.

In Chapter 3 (Fig. 3-1c), we learned that if a current-carrying conductor loop is suspended in an air gap at a right angle to a magnetic field, and current flows in one end and out the other, the forces that result generate a torque. Since the force is partially dependent on flux density, a change in the permeability of the material used in the field and armature core can alter motor performance.

Practical motor design requires that strong magnetic fields be produced and distributed in a precise fashion across an air gap which allows the movement of one member relative to the other (Fig. 5-1). While current flowing through isolated conductors will produce a magnetic field, the additional heat generated by the increased current density needed to produce useful flux levels results in practical limitations. The most effective way to produce magnetic fields 15 to 20 times as strong as that generated by conductors alone is to surround them with a ferromagnetic material.

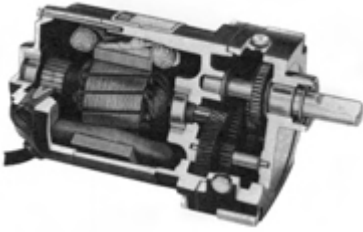

Fig. 5-1: Cutaway of DC gearmotor showing magnetic structure.

Electric motors may contain either a stationary field or a rotating field. The actual configuration depends on several factors: the supplied current (AC or DC), the type of commutation (mechanical or electronic), and the source of the field and armature flux (wound field or permanent magnet).

In electric motors, magnetic materials are used in three ways:

- 1) to form the core around which electrical conductors are wound,
- 2) to replace the coil structure as the source of the magnetic field, and
- 3) to assist the return of magnetic flux to its source.

Suitability for these tasks depends on whether the material qualifies as “hard” or “soft.” Soft magnetic materials, such as iron, nickel-iron and silicon steels, magnetize and demagnetize easily with very little energy loss when cycled. Soft materials make excellent cores and flux return rings.

Hard magnetic materials, such as ferrite, alnico and samarium cobalt, require more energy to magnetize and demagnetize.

Hard materials (also called permanent magnets) are used to replace wound coils in many applications.

Motor designs must take into account all of the practical behaviors of magnetic materials. In addition to the hysteresis losses described in Section 1.2 (Basic Magnetism), alternating and cyclic magnetization found in AC and DC motors and gearmotors produces an unwanted by-product called “eddy current effect” which can seriously impair the performance of medium and high speed motors.

Eddy currents are induced in the core material itself and flow in a direction that counteracts the primary flux change in the core. To counteract this effect, the core material can be divided into equal slices (laminations), bonded together and electrically insulated from one another as shown in Fig. 5-2. When divided into laminations, the flux in each represents only a portion of the total and the maximum induced voltage is correspondingly reduced. The greater the number of laminations, the lower the voltage and corresponding losses. Eddy current loss becomes more significant in high speed and high frequency applications, since the eddy loss is found to increase in proportion to the square of the frequency of the cyclic flux. Laminations, materials selection and techniques which increase the resistance of the eddy current path all help reduce eddy current loss.

New magnetic materials offer opportunities for more efficient motor design that seemed unthinkable a decade ago. Neody-

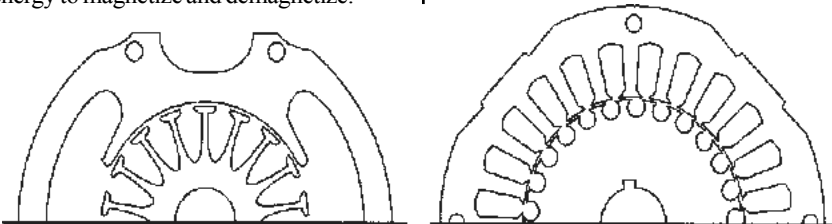

Fig. 5-2: Half view of DC field and armature laminations (left) and AC stator and rotor laminations (right)

mium-ironboron and other alloys promise magnets that are five times stronger than common ferrite magnets. Amorphous soft magnetic alloy ribbons can reduce core losses by as much as 70% when substituted for silicon steel laminations. While both soft and hard materials deliver a magnetic flux to the air gap, the effects which govern the behavior of each type of material make it practical to treat each separately.

Soft Magnetic Materials

Soft magnetic materials (iron, nickel-iron and silicon steels) are very easy to magnetize and demagnetize, a characteristic which makes them ideal for use in brush-type armature and field cores as well as induction rotors and stators. Soft magnetic materials may also be used as structural elements or enclosures that either carry flux between the source and load or act as shielding.

When specifying soft magnetic materials in motor design, factors such as mechanical strength, machinability, corrosion resistance, hysteresis loss, eddy current loss, permeability and the impact on magnetic properties of stamping or forming operations must be considered.

Figure 5-3 shows a comparison of the hysteresis loops for three common soft magnetic materials. Soft iron (Fig. 5-3a) provides low hysteresis loss (the area within the loop) with relatively high flux conducting capability (permeability). Hard steel (Fig. 5-3b) exhibits higher hysteresis loss, but somewhat lower maximum permeability. Soft ferrites (Fig. 5-3c) have lower saturation and lower permeability, but can be magnetized and demagnetized very quickly, which makes them excellent for use in equipment requiring quick response time such as computer peripherals. Figure 5-4 shows a further comparison of soft magnetic materials.

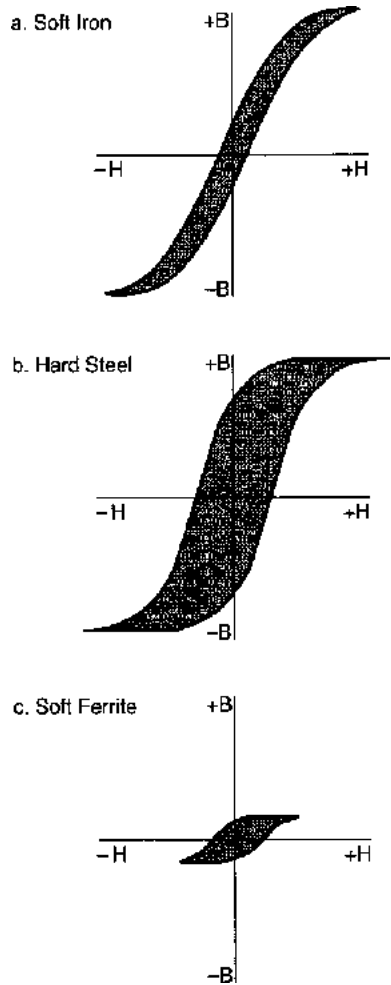

Note: B = Magnetic Flux Density
H = Magnetic Field Strength

Figs. 5-3a, b, c: Hysteresis loops for three common soft magnetic materials.

Low Carbon Iron: The popularity of low carbon iron as a core material can be explained by its combination of very high permeability, low coercive force, low hysteresis loss, high saturation and low cost. The maximum permeability of low carbon iron ranges from 2 to 7.5 kilogauss per oersted (kG/Oe). The low carbon level, however, reduces the material's strength

Material	Maximum Permeability (G/Oe)	Coercive Force (Oe)	Curie Point (C)	\$ Cost Per Lb.
Low Carbon Iron	2,000 - 7,500	1.0+	770	0.30 - 0.40
Ni-Zn Ferrite	2,500 - 5,000	0.2 - 0.5	140 - 280	5.00 - 12.00
Silicon Steels	5,000 - 10,000	0.5 - 1.0	740	0.40 - 1.00
Amorphous Alloys	500,000	0.01	415	35.00

Fig. 5-4: Comparison of soft magnetic materials.

and toughness. Iron cores are used primarily in the manufacture of relays.

Iron-Silicon Alloys: Iron-silicon alloys (silicon steels) contain nominally 1, 2.5 and 4% silicon. They were developed to enhance both mechanical strength and magnetic properties, and have been the most common soft materials used in motor core laminations. The trend is to minimize the amount of iron-silicon used because of cost. Many motor cores are produced using cold rolled electrical steel with less than 0.15% iron-silicon content. These materials can also be optimized for maximum permeability and minimum core losses by hot rolling, annealing and cooling them rapidly. Oriented four percent silicon steels may reach a maximum permeability of 55 kG/Oe.

Amorphous Alloys: Produced by cooling molten metals before they can form crystalline structures, these glass-like materials combine ease of magnetization with high strength and low melting points. Amorphous materials may provide up to 70% reductions in core loss with significant improvements in efficiency. In spite of their many advantages, these materials exhibit much higher hardness (brittleness) than silicon steels and may require radically different motor lubrication techniques to be used. Their characteristic brittleness when annealed also makes them difficult to machine.

Soft Ferrites: The most common ceramic soft magnetic materials are made from sintering the powders of iron oxides, manganese, zinc and also nickel, cobalt and cadmium. Ferrites may reach a maximum permeability of 600 kG / Oe.

Hard Magnetic Materials

Since permanent magnets provide the magnetic flux for either the rotating or stationary member of a permanent magnet motor, they must provide a sufficiently high flux density to satisfy machine requirements. In addition, they must retain this flux in the presence of a demagnetizing field at reasonably high operating temperatures.

Hard materials typically depend on cobalt as an alloying element. Higher concentrations provide both a high energy product ($B \times H$) and high Curie temperature at which a material loses its magnetic properties). With the introduction of high energy rare earth products and neodymium-iron-boron alloys, significant savings in motor size and weight may offset the higher cost of these materials. Figure 5-5 shows a comparison of hard magnetic materials.

Magnetic Steels: Cobalt steel (36% cobalt, 3 to 5% chromium, 3% tungsten, 0.85% carbon) is easily magnetized and demagnetized. The addition of cobalt

Material	Energy Product (MGOe)	Coercive Force (Oe)	Remanence (G)	\$ Cost Per Lb.
Carbon Steels	0.1	50	10,000	3.00
Alnico	2 - 10	600 - 2,000	6,000-13,000	12.00
Ferrites	3 - 5	1,600 - 2,400	2,000 - 4,000	1.40
Samarium-Cobalt	14 - 30	7,000 - 9,000	7,500 - 11,000	90.00-160.00
Neodymium	26 - 40	9,000 - 15,000	10,000-13,000	90.00-115.00

Fig. 5-5: Comparison of hard magnetic materials.

significantly increases both coercivity and the available energy product. Cobalt steels are not commonly used due to their expense, lack of a domestic source of cobalt, and their tendency to react to strong demagnetizing fields.

Aluminum-Nickel-Cobalt-Iron Alloys (Alnico): Alloys of Al, Ni, Co, Cu, Fe and Ti, alnico magnets are formed either by powdered metal processes or by casting. Alnico (alcomax in England) materials must be cooled at a controlled rate in a strong magnetic field to develop their outstanding magnetic qualities. These materials have a high flux density and are relatively easy to magnetize and demagnetize. Alnico is thermally stable and may be used at high temperatures. However, it tends to be extremely brittle and difficult to machine. Alnico is used extensively in stepper motors and other applications requiring a high performance coefficient (strength of the magnetic field vs. breadth of the air gap between magnetic poles).

Rare Earth-Cobalt Alloys:

Like many newer magnetic materials, rare earth magnets are produced with powdered metallurgy techniques. Alloys of cobalt and samarium, lanthanum, yttrium, cerium and praseodymium provide excel-

lent magnetic qualities and temperature stability. A very high energy product allows for compact magnet structures, excellent resistance to demagnetization and good temperature stability. Typically bonded to rotor structures in brushless motors, these materials are extremely costly even in small quantities.

Neodymium-Iron-Boron (NdFeB): Instabilities in the supply of cobalt have led researchers to substitute neodymium in order to obtain an alloy element which is both readily available and provides the high coercivity of the rare earth-cobalt magnets. Produced by quenching molten alloy on the edge of a rotating substrate disk, NdFeB alloys produce an energy product as high as 40 MGOe with a coercivity of 15 kOe. Although they promise to be important new materials in magnet design, neodymium alloys have relatively low Curie temperatures. With the addition of small amounts (6%) of cobalt, Curie temperatures can be raised to safe levels.

Ferrites: With more than 40% of the market for magnetic materials, ceramic ferrites are the mature entry in the magnet field. Developed after World War II, these

nonmetallic oxides of iron and other metals are pressed in powder form to the shape and size required, and are then heat-treated at temperatures between 1000°C and 1300°C. They are readily available and inexpensive, exhibit high resistivity to demagnetization and show full magnetic stability at greatest maximum field strength.

5.2 BEARINGS

In order to meet the often severe conditions of operation, a motor or gearmotor must be equipped with correct bearings. Since metal-to-metal contact during rotation causes friction and heat, the type of bearings used in a drive unit plays an essential role in the life and effectiveness of any driven machine.

Among the many considerations which affect the choice of bearings are: speed requirements, temperature limits, lubrication, load capacity, noise and vibration, tolerance, space and weight limitations, end thrust, corrosion resistance, infiltration of dirt or dust, and of course, cost. Because of the many factors which enter into bearing selection, it is evident that one bearing design cannot possibly meet all criteria and the choice must represent the most desirable compromise.

There are two principle types of bearing supports used in fractional horsepower motors: sleeve (journal) and ball. Gearheads use sleeve, ball, tapered roller, needle thrust and drawn-cup full-complement needle bearings. Figure 5-6 shows a representative sample of bearing types. In addition, the table in Fig. 5-7 outlines the characteristics of ball and sleeve bearings.

Sleeve (Journal) Bearings:

Sleeve or journal bearings are the simplest in construction and therefore, the most widely used bearing when low initial cost is a factor. They are quiet in operation, have

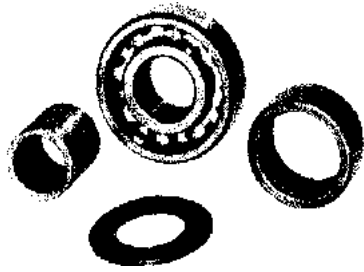

Fig. 5-6: Typical bearing types used in fractional horsepower motors and gearmotors.

fair radial load capacity, and may be used over a fairly wide temperature range. Sleeve bearings also have virtually unlimited storage life if the motor is to remain unused for extended periods. They show good resistance to humidity, mild dirt infiltration and corrosion (when made of bronze). Under light loads, static friction of sleeve bearings is nearly as low as grease-packed ball bearings (although it is higher than oil-lubricated ball bearings).

The principle disadvantages of sleeve bearings are their need for relubrication and size. They are, by necessity, longer than ball types, and in general, add somewhat to the overall length of the motor.

Sleeve bearings cannot be allowed to run dry. An oil reservoir (or felt or similar oil-retaining material) must also be incorporated into the end shield and the lubricating oil periodically replenished.

A variation of the ordinary sleeve bearing, the graphited self-lubricating bearing, is made of solid bronze, with graphite-filled inner recesses (often in the shape of two figure eights). It may also employ graphite-filled holes to conduct oil between the reservoir and the inner bearing surface. The bronze body of such bearings provides strength and resistance to shock or vibration, while the presence of graphite helps to form a lubricating film on the bearing

Characteristics	Sleeve Bearing	Ball Bearing
Load: Unidirectional Cyclic Starting and Stopping Unbalanced Shock Thrust Overhung	Good Good Poor Good Fair Fair Fair	Excellent Excellent Excellent Excellent Excellent Excellent Excellent
Speed Limited by:	Turbulence of oil. Usual limit 5000 RPM max.	20,000 RPM max.
Misalignment Tolerance	Poor (unless of the self-alignment type)	Fair
Starting Friction	High	Low
Space Requirements: Radial Axial	Small Large	Large Small
Damping of Vibration	Good	Poor
Type of Lubrication	Oil	Oil or Grease
Quantity of Lubricant	Large	Small
Noise	Quiet	Depends upon quality of bearing and resonance of mounting.
Low Temperature Starting	Poor	Good
High Temperature Operation	Limited by lubricant	Limited by lubricant
Maintenance	Periodic relubrication	Occasional relubrication. Greased bearings often last the life of the application without attention.

Fig. 5-7: Comparison of ball and sleeve bearing characteristics.

surface, and prevents metal-to-metal contact when the motor is stopped.

The graphite in the bearing will also act as an emergency lubricant if the oil level is allowed to run low. It should be noted, however, that it is not safe to depend on the graphite and allow the motor to run dry. Graphited bearings will also usually withstand higher operating temperatures than ordinary sleeve bearings.

Oil-lubricated motors or gearmotors should not be mounted in a vertical shaft

configuration except for right angle gearmotors designed for this purpose. When the oil reservoir is mounted above the motor, gravity may cause oil leakage into windings, causing subsequent motor failure and hazards to personnel. Although generally specified for radial loads, sleeve bearings can also be designed to cope with thrust loads or angle mounting. For this purpose, they may be supplied in the flange or "spool" configuration. In place of the

flange, thrust forces may also be accommodated by a hardened steel ball and disc at the end of the shaft (which can also be adjusted to control lengthwise shaft play and heavy thrusts with low friction).

Another type of self-lubricating sleeve bearing is constructed from porous bronze. The porous bronze sleeve bearing is oil-impregnated and can be used with a felt washer around its periphery to hold additional oil in suspension (eliminating the need for frequent relubrication).

Porous bronze bearings are more compact and offer more freedom from attention than solid bronze bearings. Their porous feature is achieved by powder metal fabricating techniques. Porous bronze bearings are often constructed to be self-aligning, and to reduce friction and shaft binding. The porous bearing is generally more economical than the graphited or solid bronze types and given proper design, will carry loads as well.

Ball Bearings: Ball bearings can be used for virtually all types and sizes of electric motors. They exhibit low friction loss (especially when oil-lubricated), are suited for high speed operation, and can be used for relatively wide ranges of temperatures. Ball bearings can also accommodate thrust loads, and permit end play to be conveniently minimized. Compared to sleeve bearings, ball bearings require significantly less maintenance (especially if grease-packed).

On the other hand, ball bearings are slightly more expensive. Due to the nature of the rolling action, they will also tend to be noisier than their sleeve bearing counterparts. Ball bearing manufacturers have developed special processing techniques for ball bearings used in electric motors. As a result, the difference in noise levels of sleeve and ball bearings has become minimal.

Since they are made of steel, ball bearings are more susceptible to rust. However, moisture access to the ball bearings can be precluded by proper design techniques. Grease-packed ball bearings may also have a limited storage life (motors which have been kept in storage for some time or exposed to low temperatures may show a tightening of the shaft due to lubricant hardening). This factor may require that sleeve bearings be chosen over otherwise more suitable ball bearings in some instances. In some cases, simply giving the motor some warm-up time will “rejuvenate” the ball bearing grease to a suitable condition. In recent years, greases which have long storage life have also been developed, but this advantage has been gained at the expense of limiting the rating at low temperatures.

Needle Bearings: In many gearheads, full-complement drawn-cup needle bearings may be used as supports for the gearshafts. This bearing type has a much higher length-to-diameter ratio than caged roller bearings and is generally lubricated by the lubricant in the gearhead. Compared with “pure” roller bearings, needle bearings have much smaller rollers and the highest radial load capacity of all rolling element bearings.

Needle bearings must, however, be used with a hardened steel shaft because the shaft becomes the inner race of the bearing. Maximum operating speeds are also much lower than those for ball or pure roller bearings. Their principle advantage comes with their high-load-capability-to-size ratio, providing the ability to support relatively severe radial and overhung loads in high torque, compact gearmotor drives. Needle bearings are not suitable for motor shafts chiefly because their noise levels increase somewhat exponentially with speed.

A variation, the needle thrust bearing, is also used in gearmotor application (prin-

cipally vertical shaft configurations). They employ the same type of rolling elements arranged like spokes emanating from a central hub. Set in a wafer-like retainer, needle thrust bearings can operate at reasonably high speeds with high static and dynamic load capacities.

Thrust Washers: It is common in small motors and gearmotors for thrust accommodation and/or tolerance adjustment washers to be used in situations where the thrust forces are light to moderate. Such washers are made of many materials, some of them having self-lubricating properties. Steel, nylon and graphite impregnated materials are common. In noise-critical applications, the nonmetallic materials are favored.

5.3 BRUSHES

Since they form the vital link between the power supply and the armature coils in a DC motor, brushes have always been an important consideration in DC and universal motor design. Viewed as a system, the commutator and brushes act as a rotary switching mechanism which distributes current from the power supply to the desired armature windings at the appropriate time.

Brushes must not only efficiently conduct line current to and from the armature conductors. They must also resist destruction from voltages induced in the armature coils undergoing commutation, and have sufficient bearing qualities to minimize friction and wear at surface speeds which may exceed 5000 ft/min. Almost all of the important limitations on brush performance are in some way related to the dynamic interface of brushes and the commutator. For example, friction generated at high speeds can cause sparking and nonconductive films to be formed between the brushes and the commutator if the brushes are not properly matched to the motor type and function.

While there is no magic formula for selecting the most suitable brush grade for a particular application, brush and motor manufacturers work together to narrow the choices from the many thousands of brush grades and materials available. Their final choice is based on the specific motor type and actual application parameters (since the commutation characteristics will vary depending on how the motor is to be applied).

A brush grade is considered to be ideal for a given application if it meets the following criteria:

- 1) long life,
- 2) minimum sparking,
- 3) minimum commutator wear,
- 4) minimum electrical and mechanical losses, and
- 5) quiet operation.

Since there are only a few brush grades that will deliver long life and proper commutation in any given application, proper brush selection is critical to motor performance.

To minimize electrical losses, it would seem reasonable to select brushes with low bulk resistance and a low voltage drop (contact drop) between the brush and the commutator. This approach is appropriate for low voltage motors where power-robbing voltage drops cannot be tolerated. However, it can cause excessive sparking and commutator surface damage in motors with high armature coil inductance. In these situations, brushes with high resistance and high contact drops will improve commutator and brush life by dissipating the energy in the short-circuited commutator coils and reducing the short-circuit current during switching, thus improving the overall efficiency. Mechanical factors such as commutator surface speed, wear properties of the insulation between the commutator segments (flush or undercut), and brush

dimensions must also be considered. Dimensions are particularly important because the cross-sectional contact area is proportional to the amperage-carrying ability of a given brush material.

Other motor design details such as winding type, current rating, ampere-turns ratio and type of commutator can affect brush selection in a number of specific ways. For example, series motors often operate more efficiently when designed with a lower than usual ampere-turns ratio. But, if a “normal” brush grade is used, sparking will be more pronounced and the commutator will become blackened and burned. For low ampere-turns ratio motors, a harder grade of brush with a slight cleaning action can be specified which will effectively counteract this condition.

Application parameters like frequent starting and stopping (or reversing), overload capacity, need for high efficiency, the presence of vibration or the minimizing of brush noise will all influence brush selection. In some cases requirements may be contradictory, forcing a compromise in the ultimate selection. For all practical purposes, there are four popular groupings of brush materials, covered below.

Carbon and Carbon Graphitic Brushes: Amorphous carbon (which is relatively hard) and crystalline carbon or graphite (which has good lubricating qualities) are used in varying percentages in this brush classification. The two materials are mixed and bonded together. Hard carbon and carbon graphite brushes are particularly well-adapted for use with motors having flush mica commutators (where appreciable polishing action is required to keep the mica flush with the copper bars). Their high coefficient of friction, however, generally restricts their use to slow speed motors having peripheral speeds below an upper limit of approximately 4500 ft/min (1370 m/min).

In addition, the resistance of the carbon and carbon graphite brushes limits their current density to 35-45 amperes/in² (5.4 to 7.0 amp/cm²). This characteristic generally restricts the application of this brush type to low current fractional horsepower motors.

Electro-Graphitic Brushes:

The electro-graphitic brush is made by subjecting carbon to intense heat (2500°C). The conversion to crystalline carbon or graphite is a physical (not a chemical) change.

This group of brush materials has a lower coefficient of friction than the carbon and carbon graphite class of brush and is therefore better suited for use at higher commutator peripheral speeds. The preferred average speed application is about 6500 ft/min (1980 m/min). This material is less abrasive than carbon graphite. It is also tougher, and has greater current density capability, with 75 amp/in² (11.6 amp/cm²) being fairly standard. The electro-graphitic group of brush materials is most often used to solve difficult commutation problems.

Graphite Brushes: Natural graphite is a mined product. Graphite brushes, as a class, are characterized by more polishing action than electro-graphitic grades. Their frictional properties are usually very low and their characteristic softness gives them good sliding qualities, adapting them for use at commutator peripheral speeds as high as 8000 ft/min (2440 m/min).

Due to the ability to orient the flake graphite during the manufacturing process, this material's specific resistance can be maintained at a very high level in one direction and yet achieve a current density in the range from 50-65 amp/in² (7.7-10.0 amp/cm²) in the other direction. This feature results in very favorable commutation

characteristics because short-circuited coil currents are limited during commutation, while still providing a low resistance path for the active motor current. Sparking and noise are generally low with this brush type. However, the softness, which produces quiet operation, also limits the life of these brushes.

Metal-Graphite Brushes:

Metal-graphite brushes normally contain copper and graphite in varying percentages. The two materials are either mixed and bonded together or the graphite is impregnated with molten metal.

The most important characteristic of this brush class is its extremely high current-carrying capacity, varying almost directly with the percentage of copper content (the higher the copper content, the greater the current-carrying capacity and the lower the contact drop). A brush containing in excess of 50% copper may have current-carrying capacity greater than 100 amp/in² (15.5 amp/cm²). Normal speed limits are 5000 ft/min (1520 m/min).

The life of such brushes is relatively low because of the wear properties of copper brushes sliding on copper commutators. Therefore, copper-graphite brushes are usually employed only in high-current low-voltage motors where no other brush choice is possible.

General brush application guidelines include:

1) **Shunt-wound DC motors generally exhibit better brush life than series wound motors** due primarily to their lower average speeds. However, poor commutation can result even with a standard brush if resistance is inserted into the shunt field to weaken the field strength and increase motor speed. This additional resistance alters the ampere-turns ratio relationship of the field and armature so that the armature coils are commutated in a less favorable position

in relation to the magnetic flux. This factor must be considered in alternate brush selection.

- 2) **Frequent starting and stopping** imposes challenges on brushes because of the higher starting currents involved. This factor has a particularly pronounced effect with high voltage shunt motors. Also, starting friction considerations play a role in performance. Selection of a high contact-drop brush (one with a voltage-drop of one volt or more) may be more suitable.
- 3) **Quietness of brush operation** is dependent primarily on the maintenance of uninterrupted, smooth surface contact between the brushes and the commutator. Concentricity of the commutator, brush spring pressure and fit of the brushes in their brush holders also relate to quietness. When quietness is of prime importance, the normally-used brush can be replaced with a softer grade with enough spring pressure to ensure adequate commutator contact.
- 4) **Humidity levels affect brush wear.** Low wear rates are dependent upon the formation of a conductive lubricating film on the commutator. Applications that are subjected to an environment of extremely low humidity (high altitudes) cause high brush friction and relatively rapid brush wear because of insufficient moisture to form the required film. Special grades of brushes are available and should be selected for low humidity applications. High humidity, on the other hand, may increase the electrolytic action on the brushes. To improve commutation in high-humidity applications, brushes with a certain degree of abrasiveness are normally specified.

- 5) **The presence of chemical fumes, dirt or dust** will also be a deciding factor in brush selection. Recommendations for brush grades to be used in environments subjected to those contaminants usually include brushes with some cleaning action. The use of totally-enclosed motors also helps to prevent contaminants from reaching the commutator and brushes.
- 6) **The nature of the commutator surface affects brush operation.** Satisfactory service requires that a smooth surface of uniform finish and concentricity be maintained. A change in the character of the commutator surface, for any reason, is almost certain to result in a noticeable effect on brush and commutator system performance.
- 7) **Springs.** The pressure exerted by springs holding the brushes against the commutator surface is an important consideration in the total commutation system. While specific spring composition details will not be discussed here, there are three basic spring types in general use:
- Coil Type*—Inexpensive and most popular, but contact pressure decreases as the brush wears, because the spring exerts less force as it uncoils.
 - Roll Type*—Expensive, but contact pressure is constant throughout the life of the brush due to the constant force exerted by this spring type as it coils or uncoils.
 - Lever Action Type*—The pressure exerted vs. distance traveled curve of this spring type falls somewhere in between the two previously mentioned types.
- 8) **Preventive Maintenance.** The wear rate of brushes is dependent upon many parameters (armature speed, amperage

conducted, duty cycle, humidity, etc.). For best performance, brush-type motors and gearmotors need periodic maintenance. The maintenance interval is best determined by the user.

SAFETY NOTE: Always disconnect power to the motor before inspecting or replacing brushes. Follow instructions in motor manufacturer's documentation or contact the motor manufacturer before attempting preventive maintenance.

Typical maintenance procedures include:

- < Inspecting brushes regularly for wear (replace in same axial position),
- < Replacing brushes when their length is less than 1/4 inch (7 mm.),
- < Periodically removing carbon dust from commutator and inside the motor. This can be accomplished by occasionally wiping them with a clean, dry, lint-free cloth. Do not use lubricants or solvents on the commutator. If necessary, use No. 0000 or finer sandpaper only to dress the commutator. Do not use solvents on a nonmetallic end shield if the product is so equipped.

In conclusion, the motor manufacturer has considered many factors in specifying the brushes for a particular motor design and application. For this reason, it is important to replace worn brushes with the original type (available from qualified service centers).

5.4 INSULATION SYSTEMS

An insulation system, as defined by the National Electrical Manufacturers Associa-

tion (NEMA) Standard MG-1, is “an assembly of insulating materials in association with the conductors and the supporting structural parts” of a motor. The stationary parts of a motor represent one insulation system and the rotating parts make up another.

Coil Insulation: All of the insulating materials that surround the current-carrying conductors and their associated turns and strands and which separate them from the motor structure are part of the coil insulation. These include: varnish, wire coatings, encapsulants, slot fillers and insulators, tape, phase insulation, pole-body insulation and retaining ring insulators.

Connection and Winding Support Insulation: All of the insulation materials that surround the connections which carry current from coil to coil, and which form rotary or stationary coil terminals or lead wires for connection to external circuits, as well as the insulation for any metallic supports for the windings, are considered part of the connection and winding support insulation system.

Associated Structural Parts: Slot wedges, spacers and ties for positioning the ends of the coils and their connections, as well as any non-metallic winding supports or field coil flanges, make up this insulation system.

Insulation Class	Maximum Hot Spot Temperature	
	°C	°F
A	105	221
E	120	248
B	130	266
F	155	311
H	180	356
N	200	392
R	220	428
S	240	464
C	Over 240	Over 464

Fig. 5-8: Maximum hot spot temperatures of insulation systems.

Insulation systems are rated by temperature and divided into classes according to the maximum operating temperature they can safely endure for extended periods of time. The four classes of insulation most commonly found in motors are Classes A, B, F and H. The table in Fig. 5-8 shows the hot spot temperatures for these and other classes of insulation systems.

The hot spot operating temperature is a theoretical value. Under normal conditions, a motor is operated at a temperature less than the values shown in Fig. 5-8. Various end-use standards for different types of motors and controls use different methods to measure the hot spot temperature for a given insulation system.

5.5 ENVIRONMENTAL PROTECTION

The environmental conditions in which a motor will operate are critical factors to consider when selecting a motor for a specific application. Some types of motors are more suited for specific conditions than others and some may perform well under a variety of conditions.

In some applications, the service conditions may constitute a hazard such as areas where flammable vapors accumulate and create an explosive situation. Another example would be an application which requires the motor to operate within a high ambient temperature environment for prolonged periods, increasing the risk of fire or motor failure.

NEMA has defined usual and unusual service conditions for motors. They are categorized by environmental and operating conditions as shown below:

Usual Environmental Conditions:

- 1) Exposure to ambient temperatures between 0° and 40°C,
- 2) Operation at altitudes less than 3300 ft. (1000 meters),

- 3) Installation on a rigid mounting surface,
- 4) Installation in enclosures or areas that provide adequate ventilation, and
- 5) Most V-belt, fan belt, chain and gear drives.

Unusual Environmental and Operating Conditions:

- 1) Exposure to:
 - a) combustible, explosive, abrasive or conducting dust,
 - b) conditions which could interfere with normal ventilation,
 - c) fumes, flammable or explosive gasses,
 - d) nuclear radiation,
 - e) steam, salt-laden air or oil vapors,
 - f) very humid or very dry conditions, radiant heat, vermininfested areas, or areas conducive to fungus growth,
 - g) abnormal shock, vibration or mechanical loading, and
 - h) abnormal axial or side thrust applied to the motor shaft.
- 2) Operating:
 - a) where there is excessive departure from rated voltage or frequency,
 - b) where the deviation factor of the AC source exceeds 10%,
 - c) where the AC supply voltage is unbalanced by more than 1%,
 - d) from an unbalanced rectified DC supply,
 - e) where low noise levels are required,
 - f) at higher than rated speeds,
 - g) in poorly ventilated surroundings,
 - h) under torsional impact loads, repetitive abnormal overloads, reversing or electric braking,
 - i) in a stalled condition with any winding continuously energized, and

j) a DC motor at less than 50% of rated armature current for long periods of time.

Various definitions and classification of motors have been defined by NEMA in Standard MG-1 based on a motor's ability to withstand environmental conditions. A brief summary of the environmental protection classifications for fractional horsepower motors and gearmotors is presented here.

Open Motor: One which has ventilator openings so air can flow over and around the windings for cooling.

Drip-Proof: An open motor with ventilator openings that will prevent liquids and solids dropped from an angle of 0° to 15° from vertical, from interfering with its operation.

Splash-Proof: An open motor with ventilator openings that will prevent liquids or solids that strike the machine at any angle of 100° or less from vertical, from interfering with its operation.

Guarded: An open motor surrounded by screens, baffles, grilles, expanded metal or other structures to prevent direct access to live metal or rotating parts through the ventilator openings.

Semiguarded: An open motor with ventilator openings that are partially guarded, usually on the top half.

Open, Externally Ventilated: A machine which is cooled by a separate motor-driven blower mounted on the machine enclosure.

Weather-Protected: An open motor with its ventilating passages constructed to minimize the entrance of rain, snow or other airborne particles.

Totally-Enclosed Motor: Motors that prevent the free flow of air from the inside of the motor enclosure to the outside.

Totally-Enclosed, Nonventilated: A totally-enclosed motor that is not equipped with an external cooling device.

Totally-Enclosed, Fan-Cooled: A totally-enclosed motor equipped with a separate external blower.

Explosion-Proof Motor: A totally-enclosed motor which will withstand an explosion of a specific vapor or gas within its housing, or which will prevent sparks or flashes generated within its housing from igniting a surrounding vapor or gas.

Dust-Ignition-Proof: A totally-enclosed motor which will not allow ignitable amounts of dust to enter the enclosure and cause performance loss, or which will

not permit sparks or heat generated within the motor enclosure from igniting dust or other airborne particles which accumulate around the motor.

Waterproof: A motor which will exclude a stream of water from entering its enclosure from any angle.

Encapsulated Windings: Usually a squirrel cage motor with random windings filled with an insulating resin to form a protective coating against environmental contaminants.

Sealed Windings: Usually a squirrel cage motor with an insulation system that is protected from outside contaminants by using a combination of materials and processes to seal the windings.

IP 54= IP 5 4			
IP letter code		IP 5 4	
1st digit		2nd digit	
1st digit	Protection from solid objects	2nd digit	Protection from moisture
0	Non protected	0	Non protected
1	Protected against solid objects greater than 50mm	1	Protected against dripping water
2	Protected against solid objects greater than 12mm	2	Protected against dripping water when tilted up to 15°
3	Protected against solid objects greater than 2.5mm	3	Protected against spraying water
4	Protected against solid objects greater than 1.0mm	4	Protected against splashing water
5	Dust protected	5	Protected against water jets
6	Dust tight	6	Protected against heavy seas and powerful water jets
		7	Protected against the effects of immersion
		8	Protected against submersion

IEC 60034-5 environmental protection matrix

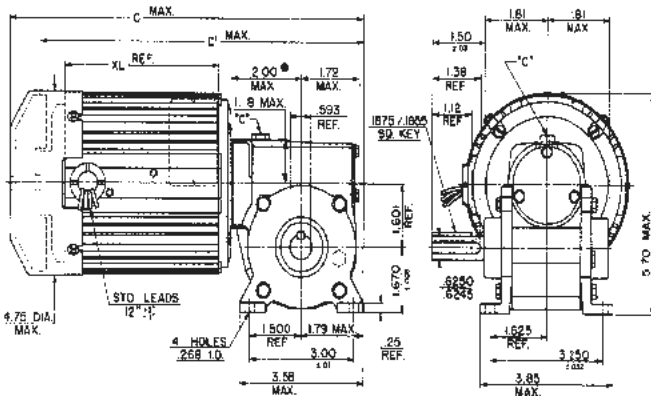

Gearhead Construction

The functionality and efficiency of a particular AC or DC type gearmotor is a factor of both the motor and the gearhead. This Chapter will focus on the mechanical aspects of the various types of gears and gear trains, which are employed in fractional horsepower gearmotors to control motor speed and output torque.

6.1 GEARING

Over time and because of varying application demands, gears have evolved from

one form to another. They can be categorized into five basic types: spur, helical, bevel, hypoid and worm. Gears facilitate power transmission by providing a positive means to engage the output of machine drives. The direction of rotation, speed of rotation, output torque, environmental conditions and efficiency requirements of a specific application determine which type of gear should be used.

Spur Gears: A typical spur gear is shown in Fig. 6-1a. Its teeth are cut paral-

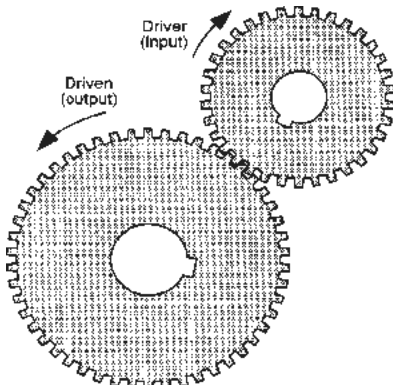

Fig. 6-1a: External-toothed spur gears.

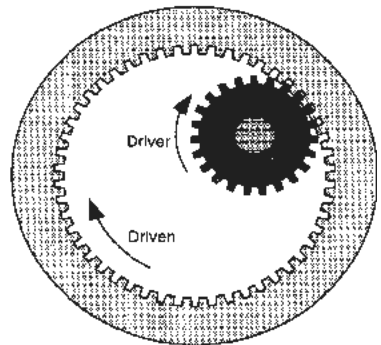

Fig. 6-1b: Internal-toothed spur gears.

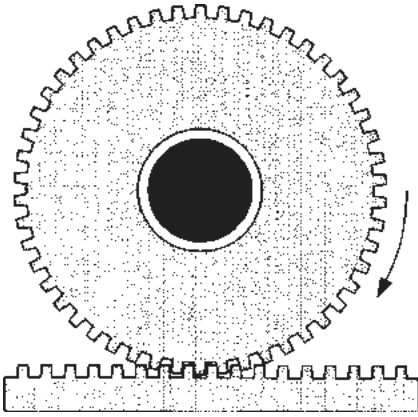

Fig. 6-2: Spur rack and pinion.

parallel to the shaft axis. Spur gears can be external-toothed (teeth cut on the outer edge) or internal-toothed (teeth cut on the inner edge, see Fig. 6-1b).

The pair of external-toothed spur gears in Fig. 6-1a makes up a single reduction stage. The output rotation of such a stage is opposite the input rotation. When multiple gear stages are combined, larger speed reductions can be achieved.

A single stage made up of an internal-toothed “ring” gear and an external-toothed spur gear produces an output rotation that is in the same direction as the input (Fig. 6-1b). Ring gears are employed

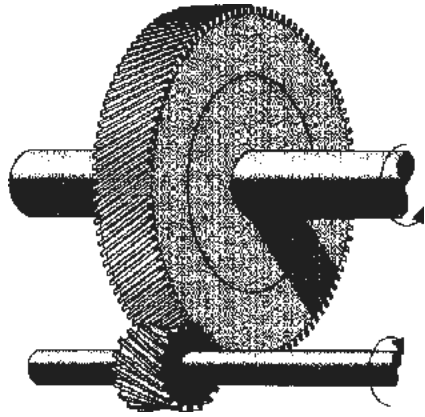

Fig. 6-3: Helical gears.

in planetary gear trains which will be discussed in the next section.

A special spur gear configuration is the rack and pinion, where the rack is simply a flat bar with teeth cut in it, which meshes with a conventional cylindrical spur gear. See Fig. 6-2.

Helical Gears: Helical gears are similar to spur gears except that their teeth are cut at an angle to the shaft axis. See Fig. 6-3. Several teeth make contact at any point in time which distributes the load and reduces wear. The noise and vibration associated with spur gears is also reduced with helical gears.

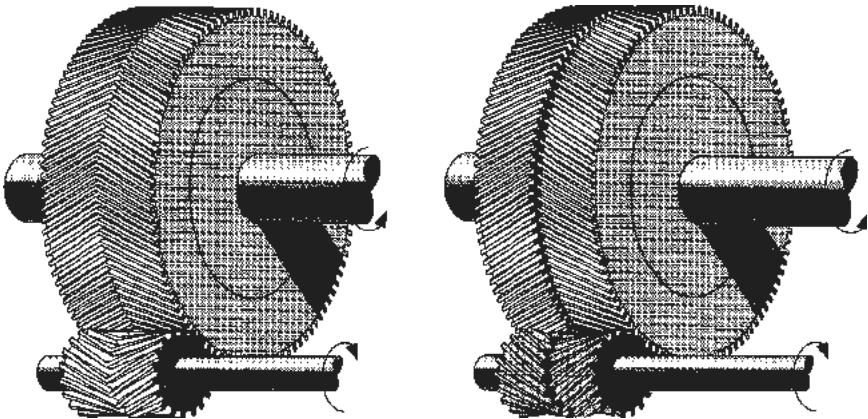

Fig. 6-4: Double helical and herringbone gears.

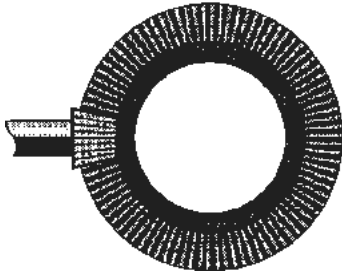

Fig. 6-5a: Straight bevel gears.

Helical gears have more stringent lubrication requirements because of the inherent sliding action between the gear teeth. Thrust bearings may be needed to absorb the side thrust which helical gears produce.

Double helical gears (two helical gears mounted side-by-side on the shaft) and a variation called herringbone gears (Fig. 6-4) are sometimes employed to eliminate the net thrust load on the shaft. In both cases, the side thrusts produced by each gear cancel each other.

Bevel Gears: Bevel gears are employed in applications where an intersection of the input and output shaft centerlines occurs. Teeth are cut from a conical or angular surface and at an angle so that the shaft axes intersect, usually at 90° . See Fig. 6-5a.

Bevel gears are available in straight and angular or “spiral” cut versions. Straight bevel gears are usually noisier than spiral cut and create side thrusts which tend to separate the two gears. Spiral bevel gears function much like helical gears. See Fig. 6-5b.

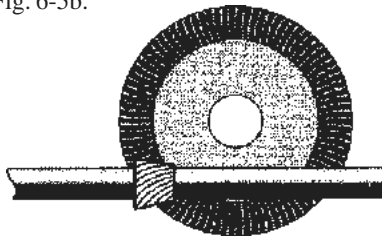

Fig. 6-6: Hypoid gears allow shaft clearance for additional support.

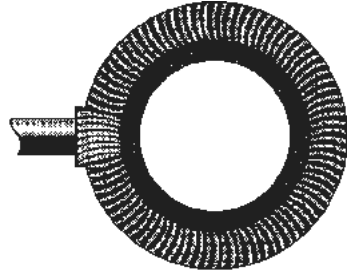

Fig. 6-5b: Spiral bevel gears.

Hypoid Gears: Hypoid gears are similar to spiral bevel gears with one major distinction. The shafts to which they are connected do not intersect as in bevel gear configurations. This allows end bearings to be installed on each shaft for additional support. See Fig. 6-6.

Worm Gears: Worm gears have screw-like threads that mesh with a larger cylindrical gear. See Fig. 6-7. It takes several revolutions of the worm to cause one revolution of the gear. Therefore, a wide range of speed ratios can be achieved from a single stage reduction. The worm is usually the driving member although reversible worm gears are available. An advantage of worm gear drives is less wear and friction due to an inherent sliding action. However, the same sliding action decreases the overall efficiency of the system.

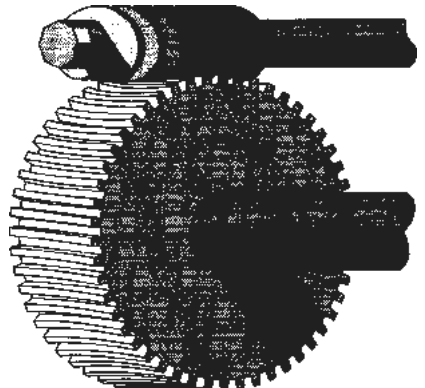

Fig. 6-7: Worm gear assembly.



Fig. 6-8: Comparison of parallel shaft gearmotors. On the left is an in-line shaft, on the right is an offset configuration.

6.2 GEAR TRAINS

The inherent characteristics of gear types have an overall effect on the power, efficiency and torque ratings of a drive when combined in different configurations. In this section, we'll take a look at how various gear trains can be used to adapt fractional horsepower motors to specific applications.

Parallel Shaft Gear Trains:

The term "parallel shaft" applies to gear trains with shafts facing the same direction as the motor shaft. In other words, the axis of the gear train shaft is parallel to the motor shaft axis.

Although the gear train shafts are parallel they can be either in-line with (concentric with) or offset from (parallel to) the motor shaft. See Fig. 6-8. The offset configuration is generally more compact than in-line designs because it eliminates the axial space needed for the bearing support of the inboard end of the driveshaft. The offset output shaft makes it possible to locate the shaft in a 3, 6, 9 or 12 o'clock position, providing greater versatility in mounting. The shaft location, however, may necessitate changing the location of oil level and oil fill plugs.

Fractional horsepower parallel shaft gearmotors usually employ spur and/or helical gearing. Both types provide high efficiency within a small axial space. Spur

and helical gears commonly provide ratios up to 6:1 per gearing stage. Spur gearing is easier to manufacture and is therefore less expensive.

Besides slightly higher cost, helical gearing often requires additional constructional features to accommodate its inherent axial thrust. The magnitude of the axial thrust forces is proportional to the load transmitted and the tooth angle of the helical gearing. Because of the greater overlapping or "load-sharing" of helical gear teeth, the transmission of power is usually smoother and quieter with helical than with spur gearing. Gear quietness is also dependent upon rotational speed. It is common in parallel shaft gearmotors for high speed stages to be helical and slower speed stages to be spur (for economy).

The efficiency of spur or helical gearing alone is about 97% per stage. Additional losses result from bearing friction and circulation of lubricant. These losses, in typical fractional horsepower parallel shaft gearmotors, reduce efficiency to about 92% per stage.

Right Angle Gear Trains: In right angle gear trains the axis of the output shaft is at a right angle (90°) to the motor shaft axis. See Fig. 6-9. They are frequently used in applications where space restricts the use of parallel shaft gear trains of comparable strength. Right angle gearmotors are especially desirable where a vertical output shaft is required.

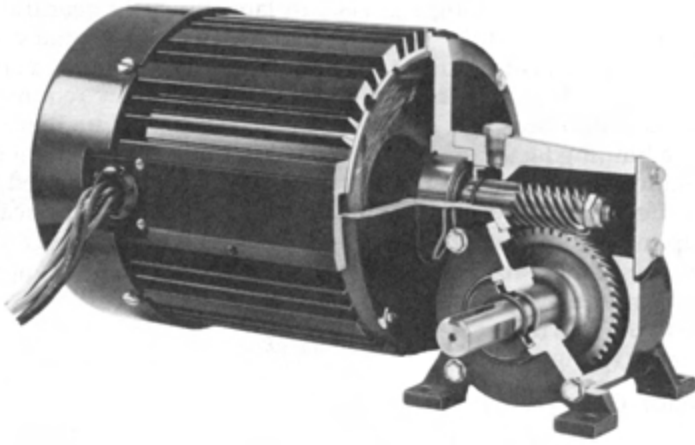

Fig. 6-9: Typical single reduction right angle gearmotor.

Right angle gearmotors can be configured with vertical shafts without mounting the gear train above the motor (an undesirable arrangement due to the risk of gear train lubricant leakage into the motor).

Various types of worm, bevel and spiral bevel gearing are used in right angle gear trains from about 1/100 to 40 hp. The cylindrical worm is by far the most popular type used in right angle designs. Ratios up to approximately 72:1 per stage are common in fractional horsepower worm gearmotors. Both single and double stage reductions are possible, and overall reductions of over 2000:1 can be achieved in two stages (with high single stage reductions). Because of the limited reduction possible with bevel gearing, it is normally used only when necessary to provide an output shaft at a right angle, but not offset from the motor shaft axis.

Precision, simplicity and reliability are some of the benefits of using worm and spiral bevel gearing. However, “self-locking” characteristics can also be achieved. Self-locking prevents external torque applied to the driveshaft from “backdriving” the motor, and depends upon tooth angles and the coefficient of friction between the worm and gear. Generally, worm gear sets

are self-locking if the lead angle is less than 5° . Gearmotors may start out being self-locking when new, but become non-self-locking as the parts wear in and efficiency improves. The manufacturer should be consulted if the self-locking feature is necessary for positioning or hoisting applications over the life of the motor.

Because the worm and gear teeth are under crushing (rather than cantilever) loads and many teeth are usually in contact, worm gears have higher resistance to shock loads than spur or helical gearing.

The sliding tooth action of worm gears offers minimal noise in comparison with spur and helical types. However, sliding tooth action is more difficult to lubricate and, as previously mentioned, less efficient than the rolling action of spur and helical gearing. The lower efficiency of worm gearing is more pronounced in the higher ratios. Worm gear efficiency also decreases with a decrease in speed. It is most critical during starting conditions where the torque multiplication may be as much as 20% less than under running conditions. This factor must be considered if the torques required by the application approach the gearmotor rating.

Thrust loads are always present with right angle gearing, and many right angle

gearmotors use rolling element bearings for severe duty conditions. Right angle gearmotors also impose relatively high thrust loads on the rotor shaft bearings, which can be a limiting factor in overall gearmotor life. Spiral bevel gearing has different efficiencies depending upon the direction of rotation. This should be considered if the torques required by the application are close to the gearmotor's maximum torque rating.

Combination Gear Trains:

Some applications can benefit from a combination of parallel and right angle gear trains. This is especially true in situations where large reductions are required and space is at a minimum. Combination gear trains accommodate right angle turns in the drive and can often result in a reduction of bearings and other system components. The right angle reduction is usually added as the first or last stage.

Epicyclic Gear Trains: Another type of gear train is the epicyclic or planetary gear train. It is comprised of three stages:

- 1) a central "sun" gear,
- 2) several "planets" which engage the sun gear and rotate around it, and
- 3) a large ring gear or "annulus" which surrounds the entire assembly and engages the planets.

Because the points on the rotating planets trace epicycloidal curves as they turn, the term "epicycloidal" is used. The term "planetary" is also applicable because the rotating action of the entire assembly about the central sun gear mimics the movement of a solar system. Epicyclic gear trains are being used increasingly as actuators in applications where more torque is required from a smaller drive train package. A typical application in the aviation industry is where a small motor must produce high

torque output to control the wing flaps on an airplane. Epicyclic gear trains are also used for differential systems and applications where very low reduction ratios are required. The input, output and auxiliary shafts can be connected to any of the three stages to achieve the speed/torque requirements of the application.

Epicyclic gear trains can be configured in three arrangements:

- 1) planetary,
- 2) star, and
- 3) solar.

See Fig. 6-10. The number of planet gears required depends on the ratio desired. The ratio also determines the type of system to be used. Each epicyclic gear train configuration can be further categorized as:

- 1) simple,
- 2) compound, and
- 3) coupled.

The simple epicyclic gear train has already been described in detail.

Compound versions consist of a common shaft with two planet members connected to it. Coupled epicyclic gear trains combine two or more simple epicyclic trains so that two elements of one train are common to the other train.

6.3 GEARMOTOR LUBRICATION

Both metallic and nonmetallic gearing are used in the gear trains of small multiple reduction gearheads. A nonmetallic gear is often used in the first stage for noise reduction and a metallic gear used in subsequent stages for strength. For reliable service life, both types of gear materials must be properly lubricated.

Long service life (10,000 hours and up) requires a fluid lubricant which is circulated throughout the gearhead. Oils or semi-fluid

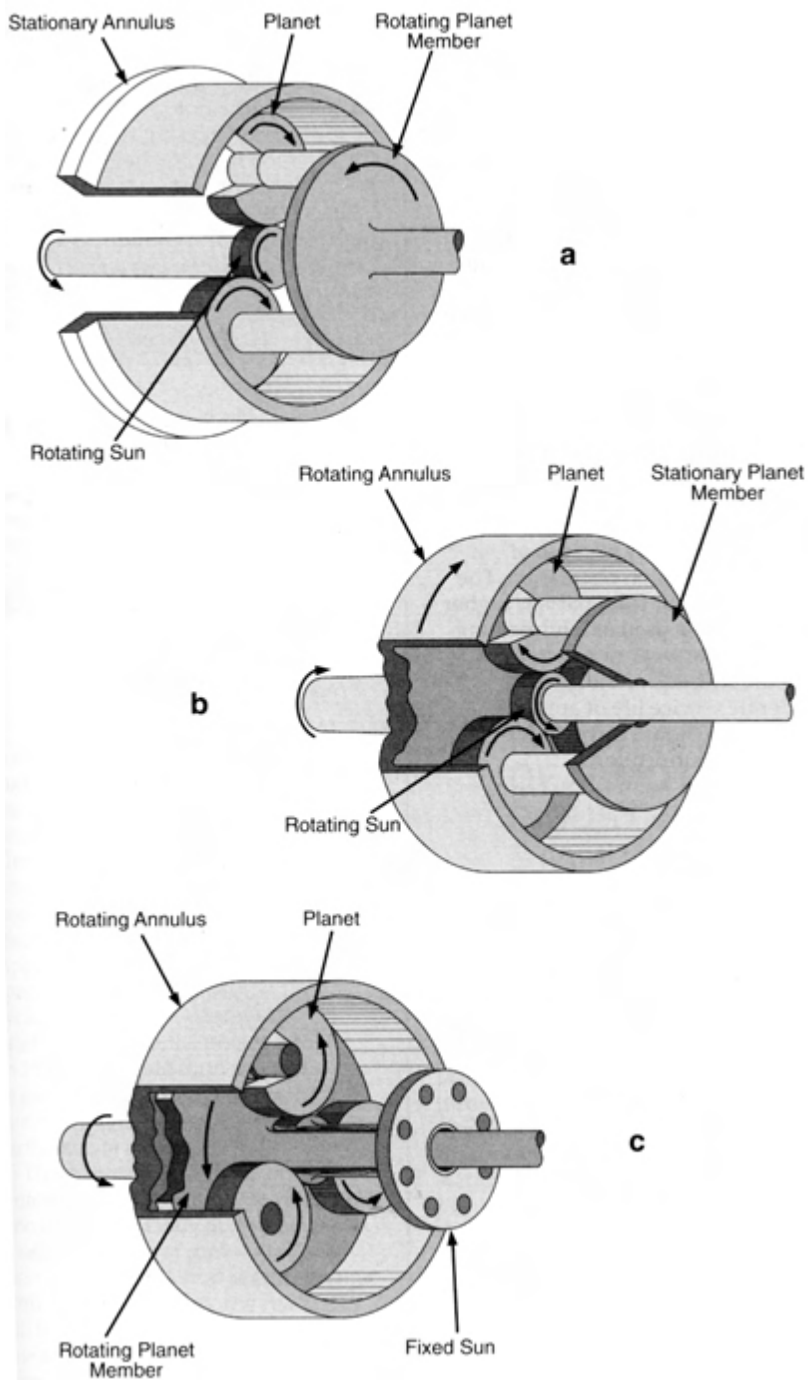

Fig. 6-10: Simple epicyclic gear trains: a) planetary (top), b) star (middle), and c) solar (bottom).

greases provide the best combination of lubrication properties and is nearly always used in gearmotors larger than 1/10 hp designed for industrial applications.

Despite its advantages, oil is not always used in smaller fractional horsepower gearmotors because of sealing problems. Gearmotors under 1/10 hp do not always have adequate surface area for gaskets and more importantly, may not have sufficient power to overcome the friction of a contact seal on the rotor shaft. Therefore, in many small fhp gearmotors, grease is used as a compromise to achieve lubrication without oil leakage.

Shorter service intervals are required when grease is used as a lubricant, primarily because of reduced lubrication circulation. The wear rate of gear train parts is higher when grease is used as a lubricating agent and the wear rate increases with the stiffness of the grease. Moderate service life of approximately 2,000 hours can be achieved with grease lubrication.

Gearhead inefficiencies (frictional losses) are converted into heat. Because of their inherent low efficiency, gearmotors with worm or spiral bevel gearing require careful attention because their lubricants reach higher operating temperatures. Worm gear lubricants generally have high viscosity and contain "extreme pressure" additives as well as other additives.

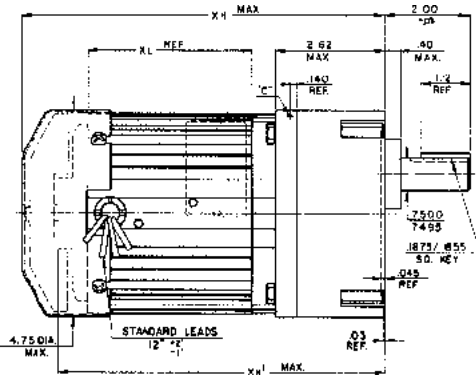

Motor/Gearmotor Selection and Application

Until now we have concerned ourselves with motor theory, operation and construction. But like any machine, motors never operate under theoretically ideal conditions. Therefore, when choosing a motor for an application, specific information about the tasks it is to perform must be known and evaluated. Application parameters such as speed, torque, drive train, duty cycle, operating environment, safety requirements, noise factors and thermal protection must all be evaluated against the type of motor being considered and its performance ratings.

This Chapter will focus on how motors and gearmotors are rated and then discuss various methods used to select and adapt motors to meet specific environmental requirements. With this information, the reader will have a better understanding of how to choose the right motor for a given application in order to assure efficient operation and required service life.

7.1 MOTOR AND GEARMOTOR INDUSTRY STANDARDS

In Chapter 5 on motor construction, we discussed the various types of motors and insulation systems as defined by the National Electrical Manufacturers Association (NEMA). NEMA has established the rating procedure for the U.S. motor industry in order to ensure safe optimum operating conditions for motors and generators. NEMA standards, in part, conform to other industry standards established by the American National Standards Institute (ANSI), the Institute of Electrical and Electronic Engineers (IEEE) and the National Fire Protection Association (NFPA).

This standardization allows for maximum interchangeability between motor types produced by different manufacturers. Conformance to the standards assures the motor customer that certain minimum guidelines are in effect for products produced by member companies.

Other organizations have also established standards for motor design to ensure safe operation and conformance to local electrical codes. In the United States, Underwriters Laboratories (UL) develops safety standards for motor enclosures,

thermal protectors and controls. Similar standards have been established in Canada by the Canadian Standards Association (CSA).

In Germany, national standards are approved by the Deutsche Institute für Normung (DIN) in conjunction with the International Electrotechnical Commission (IEC). Additional safety test specifications are also established by the Verband Deutscher Elektrotechniker (VDE).

The International Organization of Standardization (ISO) has also set standards

Organization	Standard No.	Scope
CSA	C22.2 No. 100-M1985	Motors/generators - general
CSA	C22.2 No. 77-M1988	Motors with inherent overheating protection
DIN	40-050	Motor enclosure protection
IEC	34-5	Motor enclosure protection
IEEE	IEEE-Std. 1	Temperature limits in rating electric equipment
IEEE	IEEE-Std. 43	Testing insulation resistance of rotating machinery
IEEE	IEEE-Std. 112	Test procedures for polyphase induction motors and generators
IEEE	IEEE-Std. 113	Guide for testing DC machines
IEEE	IEEE-Std. 114	Test procedures for single-phase induction motors
IEEE	IEEE-Std. 115	Test procedures for synchronous machines
ISO	ISO-R-1000	SI units and their use
NEMA	MG-1	General motor/generator design and applications standards
NEMA	MG-7	Motion/position control - motors and controls
NEMA	MG-10	Energy management - polyphase motors
NEMA	MG-11	Energy management - single-phase motors
NFPA	ANSI / NFPA 70-1987	National Electrical Code
UL	UL-519	Impedance-protected motors
UL	UL-547	Thermal protection for motors
UL	UL-1004	Electric motors - general

Fig. 7-1: Common industry standards for electric motors.

for international units of weight and measure, called the *Système International d'Unites* or SI (metric) system.

Figure 7-1 lists various design and safety standards which apply to fractional horsepower motors and gearmotors.

As mentioned previously, most standards organizations work with others to assure a level of consistency and continuity with their standards. It is beyond the scope of this *Handbook* to list every standard that is applicable to electric motors. In many cases, the ones listed in Fig. 7-1 contain references to other standards on which they were based. A list of industry associations and testing organizations is also provided in the Appendix. Most of these organizations publish an index of their respective standards.

7.2 MOTOR AND GEARMOTOR NAMEPLATE RATINGS

An electric motor or gearmotor nameplate is an extremely important source of information regarding the capabilities and limitations of the machine. Care must be

exercised to operate electric motors and gearmotors in conformance with the ratings expressed on their nameplates.

In other words, the manufacturer will indicate on the nameplate the conditions under which it is felt the product can be operated safely while giving optimum service. See Fig. 7-2. Any variation from these operating condition specifications may cause damage to the motor or gearmotor and create potential safety hazards to personnel.

NEMA defines three basic classes of electric motors for the purpose of rating: general purpose, definite purpose and special purpose. We will consider general purpose motors first, since they constitute by far the largest segment of electric motors.

Rating General Purpose Motors

A general purpose motor is not restricted to any specific application, but is suitable for "general use" under usual service conditions. Usual service conditions, as defined by NEMA, were discussed in Chapter 5, Section 5.5. General purpose motors have standard ratings and provide standard operating characteristics and construction features.

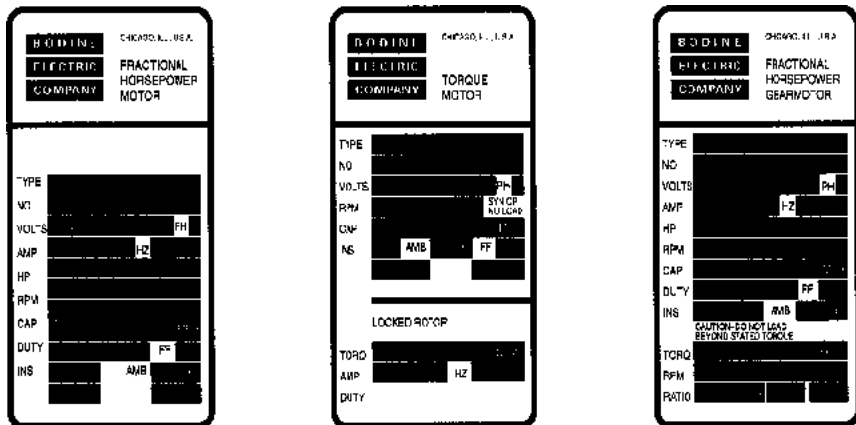

Fig. 7-2: Typical motor and gearmotor nameplates.

The Motors and Generators Standard (MG-1), published by NEMA, defines the various physical and performance characteristics which apply to these motors.

A general purpose motor is designed to develop a certain amount of power while operating continuously within safe temperature limits. The basis for rating, therefore, is a rated power output within prescribed winding temperature limits when operated for an extended period of time under usual service conditions.

The rated horsepower and speed stamped on the nameplate are those values nominally expected at rated power input. Likewise, at the rated power input, the nameplate temperature will not be exceeded when delivering rated load.

The amount of output power that can be developed in a motor is limited by the losses in the motor, resulting from transforming the electrical input into mechanical output. These losses are exhibited in the form of heat, and any attempt by the motor designer or user to increase the output of a motor beyond practical limits will produce excessive losses resulting in a temperature rise beyond safe limits. If the designed rated load or established safe torque of a motor is exceeded on an application, higher operating temperatures and / or premature failure will usually result.

Every motor has a maximum temperature limit dictated by the class of insulation material used in the motor windings, and a maximum ambient temperature listed on the nameplate. These maximum limits should not be exceeded. (See Chapter 5, Section 5.4.) For example, a motor with Class "A" insulation is designed for a maximum continuous winding temperature of 105°C in a maximum ambient temperature of 40°C.

Operation for prolonged periods in overload conditions or high ambient temperatures (above 40°C) will shorten motor life. The rule of thumb is that for each 10°C above the rated maximum temperature, the

life of the insulation system will be approximately halved.

Furthermore, prolonged operation at excessive temperatures will have a detrimental effect on the mechanical components not associated with the windings. That is, the life of seal materials and lubricants will be similarly decreased.

The output power capacity of a motor is given on the nameplate in terms of horsepower or watts and is the product of torque, speed and a constant. The formulas are:

$$\text{Power (horsepower)} = \text{torque (oz-in.)} \times \text{RPM} \times 9.92 \times 10^{-7}$$

$$\text{Power (watts)} = \text{power (horsepower)} \times 746$$

$$\text{Power (watts)} = \text{torque (newton-meters)} \times \text{RPM} \times 0.105$$

Typical standard horsepower (watts) ratings for fractional horsepower motors are 1/20 (37.3), 1/12 (62.2), 1/8 (93.2), 1/6 (124.3), 1/4 (186.5), etc. Ratings below 1/20 hp (37.3W) are sometimes classified as "subfractional" and are often rated in millihorsepower (for example, 2 mhp instead of 1/500 hp).

In addition to horsepower, the motor speed is usually shown on the nameplate. With horsepower (watts) and speed information, the rated torque can be calculated with the equation(s) above. Some standard 60 Hz fhp AC motor speeds are: 3450, 1725, 1140 and 850 RPM. These are for relatively constant speed drives. The corresponding synchronous speeds for 60 Hz AC motors are 3600, 1800, 1200 and 900 RPM.

If a motor has a gearhead, the output shaft torque rating is usually expressed in terms of torque and takes into account gearhead efficiencies and motor and gear train capabilities. With gearmotors, the motor horsepower should be regarded as primarily a

reference parameter, and the nameplate safe output torque rating should not be exceeded to assure personnel safety and gearmotor life.

Generally, both AC and DC general purpose motors will operate under slight variations in power source voltage and frequency (as described by NEMA), but may not provide the output values defined at rated voltage and frequency.

For some motors, NEMA also defines other operating characteristics for each horsepower and speed rating such as: breakdown torque, starting torque, locked rotor current and allowable speed variations.

NEMA standards do not cover all conditions or all motors, especially in the sub-fractional ratings. In these cases, reputable manufacturers make a practice of paralleling as closely as possible the standards for listed NEMA ratings.

General Purpose AC Motors: A general purpose AC motor, as defined by NEMA, is an open construction motor with a service factor rating. The service factor is a multiplier which is applied to rated horsepower to establish a permissible “overload” horsepower under defined conditions (see NEMA MG-1 paragraph 14.36 et al.). The standard fhp motor service factors listed by NEMA range from 1.25 to 1.40. A motor with no service factor indicated on the nameplate is understood to have a service factor of 1.0.

Most U.S. single-phase voltages are 115 and 230 V. Since the standard frequency in the United States and Canada is 60 Hz, this value would be indicated on the nameplate of all motors sold in those countries. In Western Europe, the nameplate would list the European standard of 50 Hz, usually at 220 or 240 V.

General Purpose DC Motors: The basis for rating fhp DC motors includes a “form factor” (ff) value. See

Chapter 8, Section 8.5. If the direct current supplied to the motor is very close to pure DC (low ripple), its form factor will be 1.0. As ripple increases, the form factor increases. A fractional horsepower DC motor is not intended to be operated continuously from a power supply that produces a form factor (at rated load) which is greater than the rated form factor. The user should also be aware that the form factor of unfiltered rectified AC and SCR type power supplies changes as a function of the output torque and speed of the motor. Operating a motor continuously at rated load with a form factor greater than rated will cause overheating and may have an adverse effect on commutator and brush life.

DC motors are often used in variable speed applications, which means they may be called on to operate at speeds lower than rated for extended periods of time. There is no consensus among standards organizations that a general purpose DC motor should be capable of operating at reduced speeds (particularly if equipped with a ventilating fan), or at a standstill with only the field energized, without excess temperature rise. It is important, therefore, that the user obtain from the manufacturer information concerning the capability of the particular DC motor under the aforementioned conditions.

In the past, common DC voltages were 115 and 230 V for motors operated from low ripple (1.0 form factor) generator-type power supplies. With the advent of efficient solid-state devices, a 90 V armature and 100 V field became popular for motors operated from an unfiltered, full-wave rectified 115 V supply. Similarly, a 130 V armature and 100 V field are popular for motors operated from filtered, full-wave rectified controls. The form factor will depend upon the particular motor and control combination and may vary by manufacturer.

Rating Definite and Special Purpose Motors

The basis for rating definite and special purpose motors is essentially the same as for general purpose motors. That is, ratings are based on developing a certain amount of power while operating within safe temperature limits (on specific power supplies) to provide long or expected motor life. The differences that do exist are due to differences in the types of applications.

For example, motor operation for definite or special purpose duty is not necessarily assumed to be continuous, as in the case of the general purpose motor; the duty cycle may be intermittent. Also, the output of a definite or special purpose motor is not necessarily expected to be a certain torque at a certain speed—starting torque may be the most important requirement (for example, as in a torque motor).

Definite Purpose Motors: A definite purpose motor is designed for use in a particular type of application, or for use under service conditions other than usual. In some instances, definite purpose motors have standard ratings and provide standard operating characteristics and construction features.

The NEMA Motor and Generator Standard, MG-1, lists the performance and construction requirements for certain definite purpose motors (oil burner motors, fan and blower motors, sump pump motors, instrument motors, etc.).

Allowable variations in voltage and frequency, and the proper application of belts, chains and gear drives, are also defined for usual service conditions. Unusual service conditions like those listed in Chapter 5, Section 5.5 must be considered.

Special Purpose Motors: A special purpose motor or gearmotor can

be considered a one-customer motor. Special purpose motors are developed when an OEM (original equipment manufacturer) defines the operating characteristics or construction features of the required drive such that a general purpose motor cannot be used. Therefore, the motor supplier must design a special motor to meet the OEM design specifications.

A special purpose motor, unlike the general purpose motor and definite purpose motor, may not have standard operating characteristics or standard mechanical features. It is designed for a particular customer's application, which has not evolved to the point that an industry standard can be written.

Although special purpose motors are not usually catalogued, the basis for rating remains much the same. The motor is again designed to develop a certain output while operating within safe temperature and mechanical limits. Unique circumstances may exist (for example, operating on an intermittent basis). When applied intermittently, a motor may be "beefed up" (a much stronger winding provided without the danger of overheating the motor). For example, high starting torques and faster motor response can be provided for servo and torque motor applications not previously obtainable under continuous duty operation.

It should be noted that NEMA defines the usual ambient service condition as a maximum of 40°C. This is why 40° is used for "maximum ambient" nameplate rating purposes for general purpose motors. In the case of definite and special purpose motors, the maximum ambient may be only 25°C. The permissible temperature rise of the motor can then be higher without exceeding the maximum recommended insulation temperature. Thus, a stronger motor can usually be supplied if it is known that the ambient is less than usual. Conversely, a higher than normal ambient would restrict

the motor output and may dictate a higher class insulation system and special lubricant and seal materials.

A special purpose motor may even be designed for shorter than normal life, because the motor (as used in the equipment) need not last longer than the equipment. Also, it is sometimes more important to satisfy other requirements such as size and power output at the expense of long life. The choice, of course, is determined by the application after a careful review of all the parameters with the customer.

IMPORTANT—Since definite and special purpose motors are designed for specific applications, they should not be indiscriminately used on other applications. They usually will give satisfactory service only in the application for which they were designed.

Rating fhp Gearmotors

Currently, there are no industry standards for fractional and subfractional horsepower gearmotors. Consequently, there has been a lack of agreement between manufacturers on gearmotor output shaft speeds, mounting methods, life vs. torque ratings and other criteria. Each manufacturer uses a different set of rating conditions.

Before any standard gearmotor ratings can be established, certain conditions for satisfactory performance must be set by the manufacturer. These criteria consist of application particulars and construction features which will ultimately affect the life of a gearmotor.

Duty cycle, ambient temperature, application load characteristics, gear materials, and bearing and gearing lubricants all contribute to the gearmotor's actual life. When comparing manufacturers' ratings, one of the most important factors (usually not published) is expected gearmotor life at nameplate rated load. Furthermore, the

design of the gearmotor involves material and component selection that optimizes its performance properties for a given application. For example, a gearmotor rated at 60 lb-in. of torque output, based on an expected life of 500 hours, could be totally unacceptable in an application which requires 40 lb-in. torque load for 2000 hours.

Expected life is a function of gearmotor design, manufacture and loading. However, tests and experience have proven that the type of gearhead lubricant is an important variable in assigning a life expectancy to a small gearmotor. Typically, grease-lubricated gearmotors are rated to perform satisfactorily (under normal operating conditions) for one year (2000 running hours). Oil-lubricated gearheads are generally rated for satisfactory performance for 5,000 to 10,000 hours at nameplate torque. Also, in recent years, the use of greases approaching the consistency of oil have enabled gearheads to have a life expectancy between 2000 and 8000 hours at rated torque.

Gearmotor Output Torque

Rating: For standard gearmotors, the torque rating shown by the manufacturer represents a complete gearmotor rating and reflects the capacity of the weakest link or most limiting gearmotor component. Some of the design limitations considered are: motor input power, strength or wear rating of the gearing, radial and / or thrust capacity of the bearings, and rotor, armature and shaft strengths. Obviously, gearmotor torque ratings should not be exceeded.

For some built-to-order gearmotor applications, a manufacturer may incorporate nonstandard gear materials to provide high shock load capacity on an intermittent basis. In such instances, the nameplate rating of the gearmotor will usually not be increased above its rated value for standard construction since the addition of

nonstandard materials does not always increase the long-term performance of the motor.

Gearmotor Output Speed

Rating: The speed value shown on the nameplate is established by one of the following methods:

- a) For constant or relatively constant speed motors (generally motors with 6% or less speed regulation with respect to load, such as: permanent split capacitor, split-phase, polyphase or synchronous types), the output shaft speed is determined by dividing the rated motor speed by the gear ratio.
- b) For variable speed motors (more than 6% speed regulation, such as: series, shunt and induction motors with high slip rotors), output speed rating is determined as follows:

Case I: The gearmotor is “motor limited”. In this case, the gearhead has more than sufficient capacity to transmit the rated motor torque. Rated motor speed is divided by the gear ratio.

Case II: The “package” is “gearhead limited”. In this case, the gearhead cannot transmit the full rated input torque provided by the motor. The actual speed provided by the motor when the gearhead is loaded to capacity is determined experimentally.

Note: Allowance must be made for seal friction if a seal is used on the input side of the gearhead. After the specific motor input speed required to drive the gearhead at its capacity has been determined (which will always be equal to or greater than the motor’s rated speed), it is then divided by the gear ratio. It should be understood that the speed at which a variable speed gearmotor actually operates in a particular application is a function of the load and its uniformity.

Hazards of Operating at Other Than Nameplate Values

Nameplate values stipulate the limits at which a motor or gearmotor can safely operate. To operate the motor either over or under the nameplate rated limit can have adverse effects on motor performance and safety. Some of the restrictions and associated consequences of ignoring them are listed below.

- 1) *Do not operate motors at voltages beyond $\pm 10\%$ of nameplate rating.* Higher voltages produce adverse effects on motor temperature, noise and vibration, operation of current-sensitive relays, motor life and capacitor life, and could create nuisance operation of thermal overload protectors. Lower voltages create starting problems with current-sensitive starting relays and could cause thermal overload protectors, with internal heating coils, to trip at winding temperatures which exceed the maximum allowable limits.
- 2) *Do not operate motors on a nominal power source frequency other than that specified on the nameplate.* With the exception of brush-type motors, motor speed will vary directly with frequency. While it is understandable that original equipment manufacturers would seek to design a machine that operates on several different frequencies, any decrease in speed due to lowering frequency may have an adverse effect on temperature and on the proper operation of centrifugal cutout switches and relays. At higher frequencies, the torque capability is reduced, and starting relays may fail to engage the auxiliary winding.
Motor laminations (and the windings installed in them) are specifically designed for operation at nameplate frequency. For

example, the laminations for 60 Hz motors are considerably different than those used for 400 Hz motors. Moreover, motor manufacturers usually do not laboratory test at frequencies more than 5% from that shown on the nameplate. Since the amount and type of noise and vibration emanating from a motor will change directly with frequency, undesirable hum and other resonance effects are quite likely with deviations from nameplate frequency.

Dual frequency (50/60 Hz) motors can be provided by manufacturers, usually at output ratings lower than the standard for a given frame size.

- 3) *Do not drive a load in excess of nameplate rating.* Where nameplate rating is in horsepower or watts, the rated torque can be readily computed by mathematical equations (relating speed, torque and power). Overload limitations also apply to gearmotors where maximum gearhead torque is shown. Technical assistance should be requested from the manufacturer if overloads are anticipated. Operation at higher torque loads can result in lower speeds, higher winding temperatures, reduced life of windings, gears and bearings, and nuisance operation of thermal overload protectors. In many cases, overloads can create hazards to personnel. Noise and vibration also increase with excessive loading.
- 4) *Do not operate permanent split capacitor motors at light loads.* An inherent characteristic of permanent split capacitor motors is that they generally run hotter at very light loads than at rated loads. To prevent PSC motors from running “too hot”, they should be matched to the application with respect to load.
- 5) *Do not exceed nameplate ambient temperature.* Lack of air intake, obstructions to the ventilation flow, and

excessive deviations from the nameplate parameters will result in excessive motor temperatures. Operating at excessive temperatures will reduce the motor life, and in general, result in decreases in motor torque and speed. High temperatures may also result in nuisance operation of thermal overload protectors, and motor start failures where current-sensitive relays are employed. These hazards can be avoided by ensuring that the application provides adequate ventilation for the motor.

- 6) *Do not indiscriminately change the value of capacitance.* This parameter applies mainly to permanent split capacitor motors. Motor start capacitors, used with split-phase motors, are normally specified to achieve maximum starting torque and / or minimum locked current and deviations are not usually made by the user. Changing to a higher value of capacitance will increase the starting torque and in some cases, speed. It can also introduce hazards such as: higher winding temperatures, shortened motor life, nuisance operation of thermal overload protectors, and increases in the level of noise and vibration. The voltage rating of the applied capacitor must also be capable of handling the voltage it experiences during operation.
Problems may be encountered with safety testing laboratories (UL, CSA, etc.) if the applied capacitor differs from the value specified on the nameplate. Always obtain assistance from the motor manufacturer when evaluating the proposed deviation and explore the possibility of changing the nameplate rating or developing a more satisfactory motor design.
- 7) *Do not subject the motor to duty cycles for which it was not designed.* Continuous (cont.) or intermittent (int.) duty, as stamped on the nameplate,

indicates the designed mode of operation for the motor and is generally based on the motor's insulation system class and the power (watts) that the motor must dissipate as heat when energized. Adverse effects can develop from operating a continuous duty motor in an application requiring a high rate of starts and stops, or from operating an intermittent duty motor continuously.

Generally, an adverse deviation in duty will result in higher winding temperatures with a shortened motor life and the possibility of nuisance operation of thermal overload protectors. Increased frequency of starts could result in failure of electrolytic motor start capacitors and a reduction in the life of motor starting switches or relays.

In summary, a motor is designed to provide satisfactory operation and long trouble-free life when operated in accordance with its nameplate specifications. The motor user should develop an awareness of the hazards that could result from any deviation from these performance characteristics, and if deviations are anticipated, the motor manufacturer should be consulted.

7.3 NOISE AND VIBRATION

Noise, quite simply, is objectionable sound. The human ear responds to two different characteristics of noise—volume (loudness) and frequency (pitch). The noise characteristic of most concern in motor operation is frequency, since motor noise can be very annoying (even at low volume) when its frequency is irritating to the ear. Objectionable vibration and noise differ only in the way they are transmitted. Vibration is transmitted by the motor structure to surrounding parts while noise is transmitted by the surrounding air. The causes of motor noise and vibration can be separated

into two general groups: mechanical and electrical. We will discuss mechanical causes first, since their effects are more obvious.

Mechanical Noise

Mechanical noise is usually a result of bearings, fans or gear trains. Some of the noise is inherent and can be minimized but not eliminated.

Another source of noise is the result of unbalanced rotation. Most motor manufacturers take precautions to balance internal rotating parts during production. The end user must take precautions to assure that motor loads are balanced. Besides noise, unbalanced rotation can cause premature wear of bearings and shafts which can shorten motor life.

Dynamic Unbalance: Dynamic unbalance is caused by the nonsymmetry of the rotating member with respect to mass. Lack of uniform wire spacing in a wound armature, nonuniformity of rotor material or attached fan assembly, or eccentricity of the shaft can all cause relatively noticeable unbalance. In fractional horsepower motors, balance can be corrected to within thousandths of an ounce-inch by dynamic balancing. Standard balance limits are established by manufacturers based on motor type, weight of the rotating member and motor speed.

Special tolerance balancing is also possible, but seldom necessary, after other noise and vibration-causing factors are checked and corrected. An easy way to check for dynamic unbalance, in some motors, is to bring the motor up to speed and then disconnect it from the power source. If vibration is still present during coasting, the problem is likely to be mechanical dynamic unbalance.

Ball Bearings: Bearing noise is very closely related to bearing speed and preload. Preload refers to an axial force

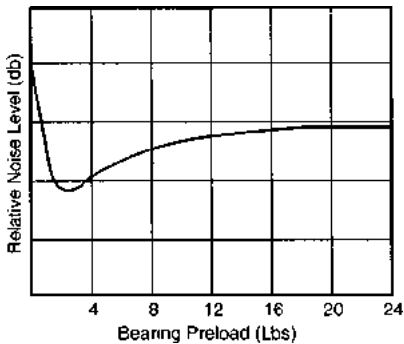

Fig. 7-3: Typical noise level vs. ball bearing preload of a fhp motor.

applied to a ball bearing to eliminate “rattling” of unloaded balls. This is commonly achieved with spring washers of various configurations which act as the bearing’s outer race. The inner race is constrained axially by the shaft shoulder. The amount of preload necessary to produce minimum noise levels is amazingly low (below two pounds for most fhp motor ball bearings). Refer to Fig. 7-3. Noise-critical applications may require a preload feature consisting of an adjustment screw to transmit the axial force (preload) to the outer race of the ball bearing. See Fig. 7-4. A locking nut maintains the factory-set adjustment screw position.

Even with carefully manufactured and electronically inspected ball bearings, motor noise levels below 40 db are very difficult to achieve, and noise levels approaching 60 db are not uncommon. The slightest variations in ball bearing manufacture can have significant effects on noise level. For this reason, pronounced variations in noise levels (10 db or more) between seemingly identical motors is common.

Sleeve Bearings: Sleeve bearings have much lower inherent noise levels, making them the first choice if their load and service limitations can be met. The most frequent problem with sleeve bearing construction is control of thrust washer

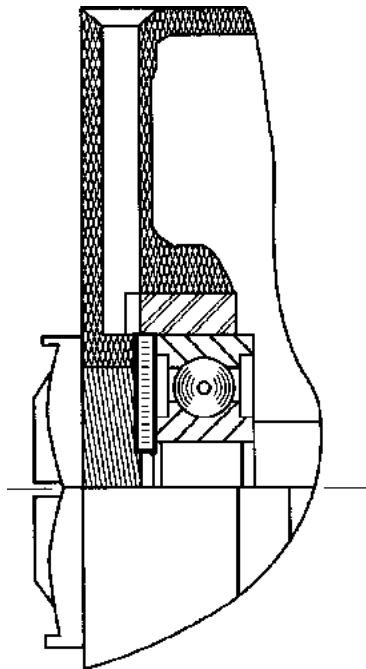

Fig. 7-4: End shield showing preload adjustment.

noise. The intermittent scraping sound from thrust washers is very difficult to control, and the use of a ball/thrust arrangement is often specified where absolute minimum noise is required.

Since sleeve bearings require clearance for proper operation (in contrast to preloaded ball bearings), they are sensitive to radial vibration, which is often experienced with a powerful motor operated at or near electromagnetic saturation, or with a high degree of dynamic unbalance. Under these conditions, and especially if high temperature thins the bearing oil film, “knocking” or “pounding” will occur in the bearing. The motor manufacturer will control shaft-to-bearing clearance tolerances more closely than normal when this condition is likely to occur.

Fans: Fans can be a major source of noise, even in low speed motors. Noise from air movement is usually very low in

frequency, at a point where the human ear is less sensitive. However, the swish or rumble of air passing through an exhaust opening can be very annoying. High speed fan design requires special attention to avoid a siren effect, and the fan blades must not be brought in close proximity to a stationary surface.

NOTE: Noise-measuring equipment should not be placed in direct line with substantial air flow, to avoid erroneous noise level readings.

Gear Trains: Gear trains may or may not contribute to overall noise levels, depending on the type of gearing and the precision with which they were made. Worm-type gearing, with its sliding contact action, is normally considered noiseless. If, however, it has a numerically low ratio with high input speed, even slight deviations from print tolerances can cause noise.

Helical gearing is also quiet because its overlapping teeth produce a smooth transfer of load from tooth to tooth. Spur gearing noise is usually the most difficult to control, especially if maximum ratio per stage of gearing is used. Under these conditions, the small number of teeth in contact at any one time causes a rather abrupt load transfer and resulting noise. This type of noise is worse under load, and generally increases in intensity as the load is increased.

An important factor with all types of gearing is the “backlash chatter” that can occur at very light loads. At light loads, even the slightest tolerance deviations in precision-made gearing will cause very slight momentary speed changes and resulting noise. Loading the gearing more heavily can eliminate the noise. Backlash noise in very lightly loaded gear trains, especially in numerically low ratios, should be considered normal. (In most cases the applied load is sufficient to load the gearing beyond the backlash noise point.)

Electrical Noise and Vibration

Although less obvious than their mechanical counterparts, electrical sources of noise and vibration can be just as disturbing. Most of the electrical sources of noise must be minimized at the manufacturing stage since they are directly related to the construction and design of the motor rather than its application.

Saturation: Over-saturation of magnetic circuits is one of the most frequent causes of excessive electrical noise and vibration. The magnetic path of any motor is designed to carry a certain amount of flux without undue magnetic stress. If the flux becomes excessive, it will not only result in increased flux leakage, but sets up excessive vibration-inducing stresses on the weakest portion of its path (usually the stator teeth) with a resultant increase in electrical noise and vibration.

Distribution of Ampere Turns: The quietness of motor operation is dependent not only on the strength of the field flux, but also on how it is distributed in the air gap. The ideal distribution is sinusoidal, with the windings (of induction motors) placed around the teeth of a slotted stator so as to produce a sinusoidal flux configuration. More stator teeth produce a more sinusoidal distribution pattern.

Permanent split capacitor type motors, which employ two windings for a more even flux distribution and a true rotating field, are inherently quieter in operation than split-phase start motors, running on one winding with a pulsating field.

Air Gap: The radial length of the air gap in induction motors has an influence on motor noise. The air gap in some motors can be increased to reduce noise. In general, larger air gaps are not desirable, since

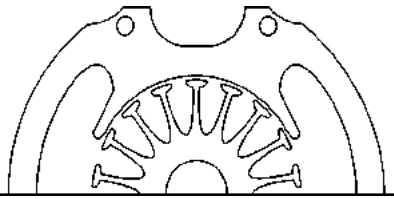

Fig. 7-5: Half-view of field and armature laminations of typical brush-type motor.

they will have an adverse effect on motor efficiency. Larger air gaps for the purpose of noise reduction are restricted, therefore, to applications that can tolerate less motor output for a given motor volume.

Quieter operation of brush-type motors can be achieved by increasing or tapering off the air gap at the tips of the field poles. See Fig. 7-5.

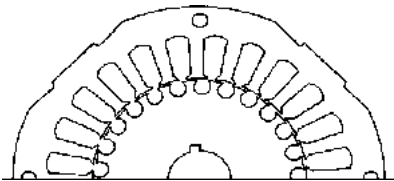

Fig. 7-6: Half-view of stator and rotor laminations of typical induction motor.

Number of Stator Teeth and Rotor Conductors: There are only certain ratios or combinations of stator teeth and rotor conductors that will produce a quiet running motor. See Fig. 7-6. However, combinations which are optimum for quiet operation tend to sacrifice motor efficiency or torque output. For this reason (unless quietness is the most important factor), motor designs will always be a compromise between desirable motor noise and necessary output and efficiency.

Salient Pole Effect: Reluctance synchronous rotor cores are normally flattened or “notched out.” The areas where ferromagnetic material remains at the outer diameter of the rotor are called salient poles. During motor operation,

these poles become areas of relatively concentrated magnetic force. The concentrated magnetic force in the salient poles makes such rotors more susceptible to magnetic imbalance, and closer tolerances must be maintained with regard to rotor position, concentricity and other magnetic symmetry considerations, in order to maintain quiet operation of reluctance-type synchronous motors.

By comparison, hysteresis synchronous motors are inherently quieter because of their nonsalient pole construction.

Number of Stator Poles: A basic stator lamination design is usually employed for all induction winding types of a given fractional horsepower motor frame, regardless of the specific operational speed desired. This is dictated by the number of stator poles wound into the stator lamination. The stator lamination geometry establishes the magnetic path for all winding types and is usually optimized for the most popular operational speed. Four-pole operation is most common. For a given horsepower output, when such a lamination is employed, the magnetic noise is usually less with a two-pole winding. When a four-pole stator lamination is used for six-pole operation, the higher flux density in the air gap generates increased magnetic noise per given hp output.

Frequency of Applied Voltage: Higher harmonics (multiples) of the line frequency are generated by all induction motors and are taken into account during lamination design. Conditions of near saturation or over-saturation magnify the harmonics and produce unwanted electrical noise. In general, the higher the line frequency, the more objectionable the electrical noise generated by the harmonics. At very low frequencies (below 25 Hz), harmonics may cause resonance effects in the motor frame, making it

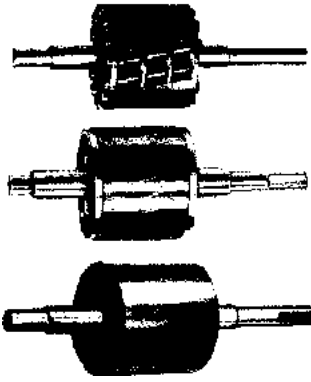

Fig. 7-7: Typical rotors: a) reluctance synchronous (top), b) nonsynchronous (middle), and c) hysteresis synchronous (bottom).

necessary to use resilient mounting to dampen the vibrations.

Skewing of Armature or Rotor Cores:

Quieter operation can be obtained when the rotating core is skewed as shown in Fig. 7-7. This permits the rotor conductors or armature winding to enter the magnetic field at an angle, reducing sudden variations in the circuit reluctance and minimizing vibration of the stator and rotor teeth. There are, however, practical limits to the angle of skew that can be used because of difficulties encountered in rotor or armature assembly. Consideration must also be given to the fact that skewing somewhat reduces the speed regulation and efficiency of a motor.

Commutation and Ampere-Turns Ratio:

Quiet operation of a brush-type motor is dependent upon good commutation. To assure good commutation in wound field motors, a proper ratio of field ampere-turns to armature ampere-turns must be maintained. Motor brushes must be designed to ride smoothly and quietly, and hold sparking to a minimum. Good commutation also depends on the correct grade of brush material to per-

mit an even commutator film build-up on the commutator and a resultant reduction in sparking.

Armature Slots: The number of armature slots of a brush-type motor has a direct relationship to the motor's noise level during operation. A large number of armature slots is considered preferable, with an even number of slots being more conducive to smooth and quiet operation.

Noise Control

In addition to measures taken by the manufacturer to ensure that motors run at minimum noise and vibration levels, there are several noise reduction procedures that can be followed by the motor user. The general approach to noise reduction can be divided into reduction of noise at its source and reduction of the airborne noise level.

The overall study of motor noise and vibration shows that in addition to the motor design itself, its use or application, its mounting and the presence or absence of sound absorbing or reflecting surfaces near the motor, each affect the measurable level of sound at the various frequencies generated by motor operation.

Reduction of Noise at Its Source:

Before attempting to reduce noise "at the source" it is important that we understand the relationship between frequency and noise or vibration. This is probably the most overlooked aspect in noise reduction studies.

Low Frequency Disturbances= Mechanical low frequency disturbance is confined to rotor or armature unbalance which occurs at the rotational frequency of the motor. In the case of a 60 Hz, 1800 RPM motor, the rotational frequency is 30 Hz. This frequency is actually below the normal hearing range. However, vibrations generated by this frequency can excite audible resonant frequencies in other parts of



Fig. 7-8: Motor frame is coupled to mounting brackets via resilient material.

the motor unless preventive measures are taken.

The most effective approach to minimizing the effects of low frequency disturbances is to use resilient mountings and couplings. See Fig. 7-8. Resilient elements such as rubber, felt, cork or springs can be placed under the feet or between the base and body of the motor. The ideal mounting is soft enough so that the natural frequency of the motor and the support system is lower than the minimum disturbing frequency. Because of other considerations (such as deflection of the mounting under load), the ideal mounting condition is not always obtainable. In general, it is best to use the most resilient mounting possible.

In those cases where vibration still presents a problem after resilient mounting, adding weight to the motor assembly may effectively reduce the vibration. For example, doubling the weight of a motor assembly can reduce the amplitude of the vibration by half.

An additional problem, often present in portable equipment, is the use of thin sheet metal panels as mounting surfaces. Thin walled structures can act as diaphragms with resulting “soundboard” effects. Some trial and error in the addition of stiffening members, or crimping, may be necessary to solve problems of this type.

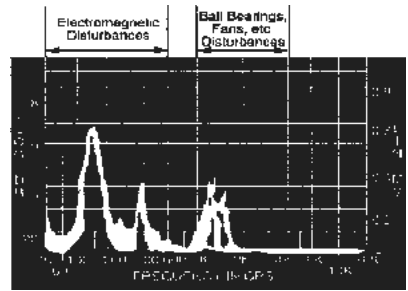

Fig. 7-9: Recorded vibration trace of a typical fractional horsepower motor. (1800 RPM at 60 Hz.)

Generally, electromechanically sourced disturbances for a 60 Hz induction motor are stronger at 120 Hz and usually negligible above 500 Hz.

High Frequency Disturbances ≡ The major sources of high frequency disturbances (in the range above 500 Hz) are caused by ball bearings and cooling fans. Brush noise can also be a factor in brush-type motors.

Ball bearing noise is usually the most troublesome noise disturbance in induction motors and almost always occurs in the 1000 to 4000 Hz range. See Fig. 7-9. Usually selecting motors with sleeve bearings will eliminate these problems provided it is compatible with the load requirements. Changing brush materials will help reduce brush noise but this should not be done without consulting the motor manufacturer. See Chapter 5, Sections 5.2 and 5.3. Airborne noise in this frequency range can be effectively lessened by the use of acoustic deadening materials.

Reduction of Airborne

Noise Level: An increase in distance between the noise source and the listener, or merely changing the relative position of the source with respect to the listener, can serve to decrease the noise level.

Acoustical absorbing materials can be used to control and reduce the noise level. Such materials are very effective in

reducing high frequency noise. However, when acoustical absorbing materials are used, care must be taken to ensure that motor ventilation is not obstructed.

Almost any degree of reduction of airborne sound can be achieved through the use of a “total enclosure” or a combination of several enclosures. Although not as effective as total enclosures, barriers may be used to shield high frequency sound.

It is important to note that motor heating usually requires that total enclosures incorporate some means of ventilation. Carefully designed ventilation ducts, lined with acoustical material, will assure that the sound reduction provided by the enclosure will not be lost by sound transmission through the ducts while motor heat is being dissipated.

7.4 THERMAL PROTECTION

Since motor overheating and possible “burnout” of winding insulation materials is a major cause of motor failure, the effects of heat on motor parts have long been an important consideration in the design and construction of electric motors. No matter how carefully they are designed and applied, temperatures over the maximum allowed for a given insulation system may occur under abnormal conditions (see Fig. 7-11). Therefore, in applications where the load, line voltage, ambient temperature, duty cycle, form factor, etc., are likely to change and result in excessive motor temperature, the addition of some type of thermal protection device is advised.

Thermal protectors are available in a wide variety of designs for specific functions, but all employ some type of sensing device which monitors motor temperature and automatically switches the machine off when a designated temperature level has been reached. These temperatures are

based on the class of insulation used in the motor. See Chapter 5, Section 5.4.

Thermal Protection Devices

A motor properly designed for the maximum normal load requirements of a specific application will provide the user with the desired motor life, safety and reliability, as long as no abnormal condition arises to increase motor heating. While the causes for abnormal conditions such as increase in the motor load, low or high line voltage, contamination of lubricants, jamming of the driven device, etc., are numerous, the end result is the same—overheating and possible motor insulation breakdown. While the breakdown of the motor insulation system may result in immediate failure of the motor, the underlying cause—overheating—is less detectable. This is especially true with fractional horsepower motors, which are usually “buried” or mounted within an external machine enclosure. Overheating for prolonged periods will create degradation of the insulation system, and bearing and gear reducer lubricants as well. Both types of degradation result in a reduction of normal motor life.

The National Electrical Code (NEC) is one basis for determining whether thermal protection is required. (UL, CSA, VDE and other safety regulatory agency requirements are also factors.) The NEC dictates that a separate overload device (thermal protector) integral with the motor—or motor impedance protection—shall be provided for a continuous duty motor (one hp or less) if the motor is:

- a) automatically controlled,
- b) manually started out-of-sight of the motor,
- c) manually started and permanently installed,

- d) manually started and over 125 volts, and
- e) manually started and operated on a branch circuit where branch circuit protection exceeds 20 amperes.

Intermittent duty motors are treated separately. The reader should refer to the latest edition of the Code to avoid any misunderstanding of the subject. Other safety controls are also considered in the Code.

As indicated by the NEC, there are various means by which the motor can be prevented from operating at excessive temperatures. Current-sensitive fuses (usually selected by the appliance or machine manufacturer), special motor design to provide high impedance (commonly referred to as impedance protection), and the use of devices that are sensitive to motor temperature or a combination of motor current and temperature, can be used to give this additional protection.

Temperature-sensitive protectors or thermostats commonly consist of a bimetallic disc, which will cause a normally closed set of contacts in series with the motor winding circuit to open if temperature exceeds a specified level. The difference in the rate of expansion between the two metals, when exposed to heat, causes the disc to change from a concave to a convex shape with a snapping action (opening the contact and de-energizing the motor). These thermostats are capable of being calibrated to specific temperatures, usually within $\pm 5^{\circ}\text{C}$.



Fig. 7-10a: In-the-winding type thermal protectors.

For motors operated from controls, the bimetallic contacts will activate a logic circuit which disables the motor. The control circuit may provide braking and may even prevent the motor from being automatically re-energized after cooling.

The type of thermostat commonly referred to as an “in-the-winding” or “on-the-winding” protector is shown in Fig. 7-10a. These types may be located in the stator winding slot or winding end-turns. The “on-the-winding” thermostat will automatically reset when the motor has cooled sufficiently. Certain appliances could result in a safety hazard to the operator if automatically re-energized. Therefore, they should not be equipped with automatic reset-type protectors.

A manual reset-type protector, equipped with a reset button that must be depressed before the motor is re-energized (even though the motor has cooled), can be mounted to the motor enclosure. The primary limitation of temperature sensitive protectors is that the mass of their enclosures causes a “thermal lag” which prevents the following of rapidly rising temperatures found under locked rotor conditions in some motor types.

Motor manufacturers also employ protectors which are sensitive to both the motor current and temperature. These protectors (Fig. 7-10b) are designed for placement in the motor enclosure and are available in both manual and automatic reset construction for single or three-phase motors. Basically, these protectors are similar



Fig. 7-10b: In-the-enclosure type thermal protectors.

to the thermostats, except that a heater coil is placed in the proximity of the bimetallic disc and connected in series with the disc and motor circuit to rapidly activate the protector under high motor overloads and locked rotor conditions.

Therefore, in the application of a current-temperature sensitive protector, it is essential that consideration be given to the motor operating current and temperature (with respect to the ultimate trip temperature of the protector) and the locked rotor current of the motor (with respect to the short trip time of the protector). The availability of ultimate and short trip time curves

from protector manufacturers has greatly simplified the proper mating of protector to motor.

A successful mating is accomplished through analysis of motor, application and protector characteristics. Premature or “nuisance” trip-outs of the protector during normal operation are as intolerable (though less damaging) as failure to prevent the motor from reaching destructive temperatures. It should be obvious that the proper matching of a protector and motor is a tailoring process involving a significant amount of testing.

UL standards UL-519 and UL-547 define the locked rotor and running

UL Requirements				
1. Maximum acceptable overload and locked rotor temperature limits (thermocouple method).				
A. Thermally Protected Motors (UL-547)				
			Maximum Temperature	
			Class A	Class B
1. Running Overload:			140°C	165°C
	Max. Temp.		* Max. Ave. Temp.	
2. Locked Rotor:	Class A	Class B	Class A	Class B
a. Automatic Reset:				
1) During 1st hour	200°C	225°C		
2) After 1st hour	175°C	200°C	150°C	175°C
b. Manually Reset:				
1) During 1st hour or 10 cycle (whichever is shorter)	200°C	225°C		
2) After 1st hour	175°C	200°C	150°C	175°C
*Multiple windings individually monitored.				
B. Impedance-Protected Motors (UL-519)				
			Maximum Temperature	
1. Locked Rotor:			Class A	Class B
1) During 1st 72 hours			150°C	175°C
2) During 15 day test			150°C	175°C

Fig. 7-11: UL-acceptable overload and locked rotor temperature limits for thermally protected and impedance-protected motors.

overload temperature limits for impedance-protected and thermally protected motors. Refer to Fig. 7-11. These temperatures, which represent maximum limits for motors employing thermal protection, are higher than those normally allowed for a particular insulation class because they are only expected to occur for short durations under abnormal conditions.

A motor properly designed to meet the load requirements of an application would normally operate under much lower temperatures (based on its class of insulation). The maximum acceptable continuous duty temperatures are specified in either UL-1446 for the type of insulation system employed or in the applicable end use standard for the specific product in which the motor is being used.

Although we are still faced with the threat of abnormal conditions attributed to the causes mentioned earlier, plus the never-ending uniqueness of machine operators in creating "improbable situations," the use of thermal protectors in motors will provide greater assurance of safe, reliable operation and long life of electric motors.

7.5 ENERGY MANAGEMENT

Proper selection, application and maintenance of electric motors is essential to an effective energy management program. With increasing shortages and higher costs, energy management is becoming increasingly important. It is crucial to mankind from the standpoint of conservation of natural resources, energy independence and energy availability. As part of a system, electric motors play a significant role in total energy consumption. However, they cannot be considered alone and are only one of many factors in the analysis of an entire system.

Users and specifiers of electric motors must now, more than ever, understand the proper selection, application and maintenance of drive components. Reprinted below are excerpts from the *NEMA Energy Management Guide for the Selection and Use of Polyphase Motors* (NEMA No. MG-10) and the *NEMA Energy Management Guide for Selection and Use of Single-Phase Motors* (NEMA No. MG-11). Contact NEMA for more information.

Efficiency

The efficiency of a motor is the ratio of its mechanical output to its electrical input. It represents the effectiveness with which the motor converts electrical energy into mechanical energy. The efficiency of a motor is a function of the load, horsepower rating and speed, as indicated below.

- 1) A change in efficiency as a function of load is an inherent characteristic of motors. Operation of the motor at loads substantially different from rated load may result in a change in motor efficiency.
- 2) Generally, the efficiency of motors, as measured at rated load, increases as the motor horsepower rating increases. That is, large motors are inherently more efficient than small motors.
- 3) For the same horsepower rating, motors with higher speeds generally have a higher efficiency at rated load than motors with lower rated speeds. This does not imply, however, that all apparatus should be driven by high speed motors. Where speed changing mechanisms, such as pulleys and gears, are required to obtain the necessary lower speed, the additional power losses of the mechanisms may reduce the efficiency of the system to a value lower than that provided by a direct-drive lower speed motor.

A definite relationship exists between the slip and efficiency of an induction motor (the higher the slip, the lower the efficiency) because slip is a measure of the losses in the rotor winding. Under steady load conditions, squirrel cage induction motors with less slip should be used, if the application permits.

Slip of an induction motor is expressed (approximately) in the following equation:

$$\% \text{ Slip} = \frac{N_{NL} - N_{FL}}{N_{NL}} \times 100$$

where: N_{FL} = Full load speed
 N_{NL} = No load speed

The efficiency of a multi-speed motor at each operating speed is somewhat lower than that of a single-speed motor having a comparable rating. Single-winding multi-speed motors are generally more efficient than two-winding multi-speed motors. Significant energy savings may be possible by operating at low speeds where possible, and at high speeds only when necessary.

Motors which operate continuously or for long periods of time provide a significant opportunity for reducing energy consumption. Examples of such applications are processing machinery, air-moving equipment, pumps and many types of industrial equipment. A small change in motor efficiency can make a significant change in total energy consumed per annum, due to the lengthy operating time.

While many motors operate continuously, some motors are used for very short periods of time and for a very low total number of hours per year. Examples of such applications are valve motors, dam gate operators and industrial door openers. Thus, a change in motor efficiency would not substantially change the total energy consumed since very little total energy is involved.

Viewed from a motor losses standpoint, a modest increase of a few percentage points in motor efficiency can represent a

significant decrease in percentage of motor losses. For example, for the same output, an increase in efficiency from 75% to 78.9%, from 85% to 87.6% or from 90% to 91.8% may each represent a 20% decrease in motor losses.

For two similar motors operating at the same specified load but having different efficiencies, the following equation can be used to calculate the savings in operating costs when using motor A rather than motor B:

$$S = (0.746)(hp)(C)(N)\left(\frac{100}{E_a} - \frac{100}{E_b}\right)$$

where:

S = savings (dollars per year)

hp = horsepower rating of the specified load

C = energy cost (dollars per kilowatt hour)

N = running time (hours per year)

E_a = efficiency (in percent) of motor A at the specified load

E_b = efficiency (in percent) of motor B at the specified load

The equation applies to motors operating at a specified constant load. For varying loads, the equation can be applied to discrete portions of the cycle where the load is relatively constant for a reasonable increment of time. The total savings are the sum of the savings for each load-time period. This equation is not applicable to motors operating on pulsating loads or on loads which cycle at rapidly repeating intervals.

Motor Losses

An electric motor converts electrical energy into mechanical energy incurring losses which are described here in general terms (for a more accurate explanation of losses, see IEEE Test Codes 112 and 115). These losses are converted into heat, causing the temperature of the windings and other motor parts to rise.

Electrical Losses (vary with load): Current flowing through the motor winding produces losses which are approximately proportional to the current squared times the winding resistance (I^2R). Similar losses result from current flowing in the squirrel cage of an induction motor.

Iron Losses (essentially independent of load): These losses are confined mainly to the laminated core of the stator and rotor. The alternating magnetic field, essential to the production of torque in the rotor, causes hysteresis and eddy current losses that increase with frequency.

Mechanical Losses (independent of load): Mechanical losses occur in the bearings, fans and brushes (when used). In open, low-speed motors, these losses are small. However, they may be appreciable in large, high-speed or totally enclosed, fan-cooled motors.

System Efficiency

Since the system efficiency is the combination of the efficiencies of all of the components of the system, good energy management requires a consideration of the total system of which the motor is a part. Typical factors to be considered are covered below.

Motor Rating: The optimum motor rating necessary to handle the load should be determined. Where the load is constant, the appropriate motor rating is readily indicated. A close matching of motor and load generally optimizes the economic considerations. Moreover, the selection of a motor rating adequate for the load is important to avoid unnecessary losses which consume energy and might overheat the motor. The use of motors having an output rating excessively greater than the load causes a reduction in the system power factor, with resultant added losses in the distribution system.

Application Analysis: When the driven machine provides a widely varying load involving a number of stops and starts, a careful analysis of the application can result in savings in energy. Operating conditions such as starts, plug stops, reversals, some forms of braking, etc., all consume energy at rates much higher than when the motor is operating continuously at a rated load. When variable duty cycles are encountered, two actions can be taken to minimize energy usage. The first is to reduce the mass of the moving parts wherever possible, because energy used to accelerate these parts is proportional to the mass or inertia.

Secondly, all aspects of the load should be carefully analyzed. This should involve consultation with the motor manufacturer for recommendations. Motors which are designed for high full-load efficiency may not be suitable for applications involving frequent starting, intermittent duty operation and repetitive pulse loading.

Process and Machinery: The most efficient process and machinery should be selected. Frequently, alternate means are available for doing a job, and a variety of machines often exist that are capable of performing the task. Once these determinations have been made, the appropriate motor rating and design type consistent with system economics can be specified.

First Cost vs. Long-Range Energy Costs: For variable and multi-speed drives, the first cost and long-range energy costs should be carefully evaluated because such systems vary widely in first cost and in operating efficiency, (i.e., the choice of multi-speed or adjustable speed motors as compared to throttling control), or the choice of a high-speed motor with speed reduction as compared to a low-speed motor.

Maintenance

Because the electric motor generally needs little maintenance, it is often neglected. Proper care of the motor will prolong its life and will conserve the material which would be needed for replacement if it fails prematurely. A basic motor maintenance program requires periodic inspection and, when encountered, the correction of unsatisfactory conditions. Among the items to be checked during inspection are: lubrication, ventilation and the presence of dirt or other contaminants which form a heat transfer barrier, alignment of the motor and load, possible changing load conditions, belts, sheaves, couplings, and the tightness of the hold-down bolts.

Sometimes, additional friction develops within the driven machine as a result of a dust build-up on the fan, wearing of parts, misalignment of gears or belts, or insufficient lubrication in the driven machine. These conditions cause the driven machine to become less efficient by making the motor work harder, thus reducing system efficiency and increasing energy consumption.

All motors should be provided with proper overload protection at the time of their initial installation. If the protective device should trip, the cause should be determined immediately. Increasing the trip rating of the protective device should be avoided because it may:

- 1) conflict with the National Electrical Code,
- 2) permit overheating of the motor,
- 3) waste energy,
- 4) mask the problem, and
- 5) create hazards to personnel.

To ensure continued efficient operation and long motor life, a regular schedule for inspecting motors and driven equipment should be established.

7.6 LOAD TORQUE MEASUREMENT

In order to determine the size of a motor or gearmotor to optimally drive a given machine, a host of variables must be known. Perhaps the most significant of these is the torque or turning force needed to rotate the machine shaft from standstill through the different stages of its operating cycle.

Torque requirements may vary depending on the machine. In some inertial load devices, maximum torque is required at the start to bring the machine up to speed, while the necessary running torque is a fraction of the starting requirement.

Other machines such as a printer may start with no load applied, and at some point later in the cycle, clutch in the maximum load. See Fig. 7-12. In this application, the average torque must be sufficient to drive the machine without noticeable decreases in drive speed when peak loads are seen by the drive. If the machine can stop at peak load, the drive starting torque must be sufficient to start the peak load. Because these kinds of variations exist, one must know starting and running torque as well as peak loads occurring in the machine cycle. In some cases it is not practical to measure peak requirements, and average running torque must be given.

Whenever possible, it is extremely useful for machine designers to supply the motor manufacturer with load diagrams like that illustrated in Fig. 7-12. Such load vs. time graphs are valuable in selecting a

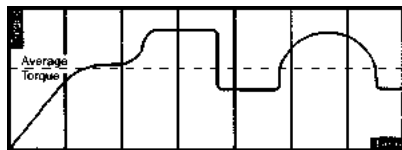

Fig. 7-12: Load diagram for a machine that starts at essentially no load, with peak loads occurring later in the cycle.

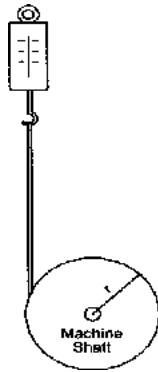

Fig. 7-13: Simple string and pulley torque measurement method. (Torque = force reading on scale x radius of pulley.)

motor with the best set of performance characteristics for a given application.

In making a final load requirement diagram, it is important to consider not only the load cycle itself, but any anticipated changes that may occur over the life of the machine. Most machines will tend to “loosen up” after a break-in period, while some (particularly those in hostile environments) may actually “tighten.” Obviously, the load diagram should reflect the most demanding torque condition of the machine.

NOTE: This discussion concentrates on the determination of torque requirements. Other factors are important in final drive selection, and the Application Guidelines outlined in Section 7.8 should be reviewed before the final selection is made.

There are three principle means by which torque can be measured:

- 1) the “string and pulley” method,
- 2) the torque wrench method, and
- 3) the “test” motor method.

The String and Pulley Method:

Affix a pulley to the shaft of the machine to be driven. See Fig. 7-13.

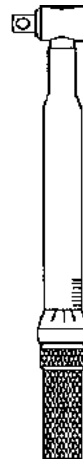

Fig. 7-14: Typical torque wrench.

Secure one end of a cord to the outer surface of the pulley and wrap the cord around it a few times. Tie the other end of the cord to a spring scale (like those used to weigh fish). Pull on the scale until the shaft turns. The force, in pounds indicated on the scale, multiplied by the radius of the pulley (in inches) gives the torque or twisting effort in pound-inches (if the scale is read in ounces, the result will be in ounce-inches).

Depending upon the application and if used carefully, this method is often successful in determining both starting and running torque. The spring scale reading, when the pulley begins to turn, indicates starting force. If a long enough string can be used, an indication of the average running torque can be obtained. When the torque characteristics of the machine vary in different parts of the operating cycle, the starting torque must be determined at the point where the motor or gearmotor will “see” the highest resistance (torque) to starting.

Torque Wrench Method: A simple torque wrench can also be applied to the shaft of the machine to be driven. See Fig. 7-14. Turn the wrench as you

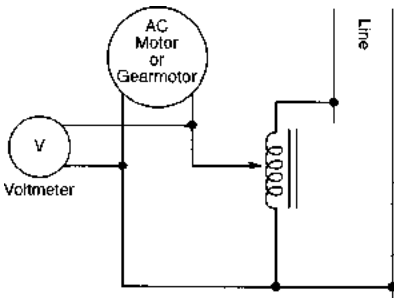

Fig. 7-15: AC motor or gearmotor with adjustable autotransformer.

would an ordinary pipe wrench, and when the shaft begins to rotate, read the value (in ounce-inches or pound-inches) on the torque wrench gauge. The observed value represents the torque required to start the machine.

This method is generally limited to measuring starting torque or peak torque since it is unsafe and difficult to continuously rotate a torque wrench.

“Test” Motor Method: Both AC and DC test motors or gearmotors can be used to measure a machine’s starting and running torque. This method requires more time and instrumentation, but can be well worth the expense in the long run. It is the best way to optimally match the machine and drive unit, and is popularly used for all high volume OEM applications.

Whether AC or DC drives are used, the method is basically one of experimenting with an “oversize” drive at reduced power levels, recording the experimental readings, and then bench-testing the drive to determine the torque that was being produced at the recorded readings. The method is actually a variation of dynamometer testing a machine (the test motor is, in reality, a substitute dynamometer).

AC Method: Use a torque wrench or “string and pulley” to find the approximate size of the test motor or gearmotor

needed. An AC motor or gearmotor whose rated output speed is close to the desired “final” speed of the machine should be obtained. Next, connect the AC drive, powered by a variable autotransformer to the load as shown in Fig. 7-15.

With a voltmeter connected to the line, increase the voltage supplied by the autotransformer until it starts and accelerates the load up to speed. (To check the speed, use a tachometer or stroboscope.) Record the starting voltage at all possible starting locations of the device. Next, back off slowly until the motor breaks down. Read the voltage and supply the data and the test motor (gearmotor) to the manufacturer.

DC Method: The DC method, utilizing a permanent magnet DC motor, provides the experimenter with more latitude in that the speed of the device can be varied. This can be an advantage if the “final” speed of the machine has not yet been decided and experimentation is desired for optimizing.

The DC method requires the measurement of the test motor input voltage and current once the desired operation of the load is achieved. Speed of the DC motor is proportional to voltage while torque is proportional to the current. For maximum accuracy, the actual test motor should be sent to the manufacturer with the voltage, current and speed information for dynamometer testing. The minimum starting torque should also be supplied.

7.7 MOTOR SIZING

While determining the maximum torque requirement for a potential application is important, many other performance characteristics may affect machine operation at different stages of the operating cycle.

The motor speed / torque curve should be examined to determine if the load can be started and accelerated to running speed. When the time accelerate the load

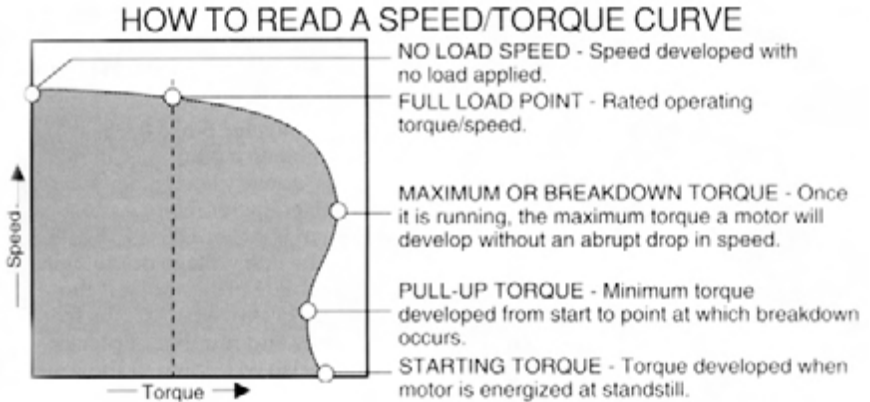

Fig. 7-16: How to read a speed / torque curve.

is a specified requirement, additional acceleration torque must be available in excess of the needs to overcome friction. It is also important to be sure that the motor selected can cope with peak load requirements. The curve shown in Fig. 7-16 contains the basic speed / torque information for a typical AC squirrel cage, nonsynchronous motor.

7.8 APPLICATION GUIDELINES

Proper application of any motor or gearmotor requires careful preliminary planning. The factor which most often determines the success or failure of a motor-driven device is the initial care exercised in matching the load characteristics of the machine to be driven with the performance characteristics of the motor to be used as the driving member. A motor too large or too complex is unnecessarily expensive to purchase and operate, while a motor too small may fail to drive the load under all conditions to be met in the normal course of the application.

The characteristics chart shown in Fig. 7-17 provides a good general guide to the selection of a proper motor with respect to electrical type, but many other factors must

be taken into consideration before the final selection is made.

Unfortunately, some of the more important factors are not always apparent and may be recognized only by an applications engineer having years of small motor design experience.

Supplying Application Data

Unnecessary communications, loss of time, excessive development and experimental costs, and repeated trial and error can often be avoided if a machine designer supplies the motor manufacturer with complete application data before the design of a driven machine reaches the detailing stage. Figure 7-18 shows a typical application data sheet provided by motor manufacturers to assist product designers in supplying all information necessary for motor selection. Since this selection process is critical, we will consider each point individually.

- 1) *Product to be Powered?* What kind of machine is it and what kind of work will it be expected to do? (For example, main drive for an office copier, reel drive for a magnetic tape deck, etc.)
- 2) *Estimated Quantity?* Is the production run to be large or small? This

question is asked because the feasibility of some alternative solutions may depend upon the quantity projected.

3) *What Does the Motor Drive?* The first question defines the end product. This question determines how the motor or gearmotor is related to the operation of the machine. The function of the motor may take on many forms. In its simplest form, the motor may be directly coupled to the load (as in a grinding wheel in a lathe attachment). On the other hand, the motor may be the main

source of power for several functions in a machine via chains, gears, belts, etc.

4) *Power Supply?* Since the power available to a plant has, in most cases, already been installed, this is a fixed factor. Here it must be known if AC or DC is to be used, and the line voltage or voltages available. Furthermore, if the source of power is AC, the frequency and number of phases must also be known. If the source of power is not pure DC, the form factor must be known. Sometimes there is a choice of

	Duty	Typical Reversibility	Speed Characteristic	Typical Start-Torque	
Polyphase	AC	Continuous	Rest or Rotation	Relatively Constant	175% & up
Split Phase Synch	AC	Continuous	Rest Only	Constant	75 - 150%
Split Phase Non Synchronous	AC	Continuous	Rest Only	Relatively Constant	175% & up
PSC Non Synchronous High Slip	AC	Continuous	Rest or Rotation	Varying	175% & up
PSC Non Synchronous Normal Slip	AC	Continuous	Rest or Rotation	Relatively Constant	75 - 150%
PSC Reluctance Synchronous	AC	Continuous	Rest or Rotation	Constant	75 - 150%
PSC Hysteresis Synchronous	AC	Continuous	Rest or Rotation	Constant	125 - 200%
Shaded Pole	AC	Continuous	Uni-Directional	Relatively Constant	50 - 60%
Series	AC/DC	Intermittent/Continuous	Uni-Directional	Varying	175% & up
Permanent Magnet	DC	Continuous	Rest or Rotation	Rel. Constant & Adjustable	175% & up
Shunt	DC	Continuous	Rest or Rotation	Rel. Constant & Adjustable	125 - 200%
Compound	DC	Continuous	Rest or Rotation	Rel. Constant & Adjustable	125% & up
Shell Armature	DC	Continuous	Rest or Rotation	Rel. Constant & Adjustable	175% & up
Printed Circuit	DC	Continuous	Rest or Rotation	Rel. Constant & Adjustable	175% & up
Brushless DC	DC	Continuous	Rest or Rotation	Rel. Constant & Adjustable	175% & up
DC Stepper	DC	Continuous	Rest or Rotation	Constant & Adjustable	N/A

Fig. 7-17: Motor characteristics chart.

APPLICATION INFORMATION

BODINE**ELECTRIC****COMPANY**

Company _____
Address _____
City _____ State _____ Zip Code _____
Name _____ Title _____
Phone Number _____ Date _____

This form has been prepared to assist you in supplying us with the basic information required to propose a trial motor for your application. The success of the motor selected will depend upon the accuracy and completeness of the information you supply.

1. Product to be powered: _____
2. Estimated quantity requirements: Initial order _____ First year _____
3. What does motor drive? _____
4. Power supply: 115 VAC, 60 Hz () _____ Other _____
5. Fixed speed _____ RPM. Allowable variation _____ %.
6. Variable speed (universal or DC motors only) _____ to _____ RPM.
7. Direction of rotation viewing drive end of motor or gearmotor:
CW () CCW () Reversible () Optional ()
8. Load requirements and conditions: Load data obtained from present practice (), estimated (), determined by actual test (). If equipment was successfully driven by a Bodine or competitive motor, give complete nameplate data.

a) Continuous load _____ torque.
b) Intermittent load _____ torque.
 - 1) Maximum length of time at full load _____
 - 2) No-load running time _____ Average time at rest _____
 - 3) Maximum momentary or peak torque _____c) Reversing service:
 - 1) Maximum reversals per minute _____
 - 2) Must motor reverse while rotating? () Or from rest? ()d) Shock loads, if any. Describe _____
- e) Radial loading:
 - 1) Directly applied type: Indicate (by sketch on next page, No. 20) magnitude, direction, and point of concentration of loads such as initial belt tension, supported weight, etc. Show front and side views.
 - 2) Reaction type: Indicate (by sketch on next page, No. 20) how motor is coupled to driven load, giving pitch diameter of pinion, worm, sprocket or pulley, location on shaft, and direction of load. Show front and side views.f) Axial loading: What is magnitude and direction of load? (Show by sketch on next page, No. 20). If worm drive is contemplated, include complete worm data.
- g) Direct drive: If load is coupled directly to shaft, describe type of coupling employed _____
- h) Is motor started under load? _____ If so, what is starting torque required? _____
- i) Is load of inertia (flywheel) type? _____
- j) Is time a factor in bringing load up to speed? _____
9. Life expectancy of motor _____ hours. (Motor life varies with operating and load conditions, and duty. Normal duty is considered to be 8 hours per day, 5 days per week, or 2000 hours per year.)
10. How frequently will motor be serviced? (annually, quarterly, monthly, never)
 - a) lubrication _____
 - b) brushes _____
 - c) general cleaning _____

Fig. 7-18: Application data sheet (continued on next page).

11. Space and weight limitations, if any _____
12. Motor mounting: Standard Floor (), Other (). Show by sketch (in space below, No. 20) if other than standard floor mounting.
13. Temperature surrounding motor: Max. _____ °F, Min. _____ °F
14. Is equipment designed to provide adequate ventilation to motor? _____ How? _____
15. What is the condition of the air surrounding the motor? (dusty, gritty, humid, acid, explosive, etc.) _____
16. Shaft end play restrictions _____
17. Shaft dimensions if other than standard _____
(If shaft features are complex, show by sketch.)
18. Electrical leads:
- a) Bodine standard acceptable ().
 - b) Special material or length (). Describe _____
 - c) Cord (). Describe, including type, length, plug or switch specifications, etc. _____
 - d) Terminal box ().
19. Give additional requirements not covered by the above data such as UL, CSA, sanitary, municipal or military, braking, overload protection, degree of quietness, etc. (Describe fully) _____
20. Use this space for sketches as required.

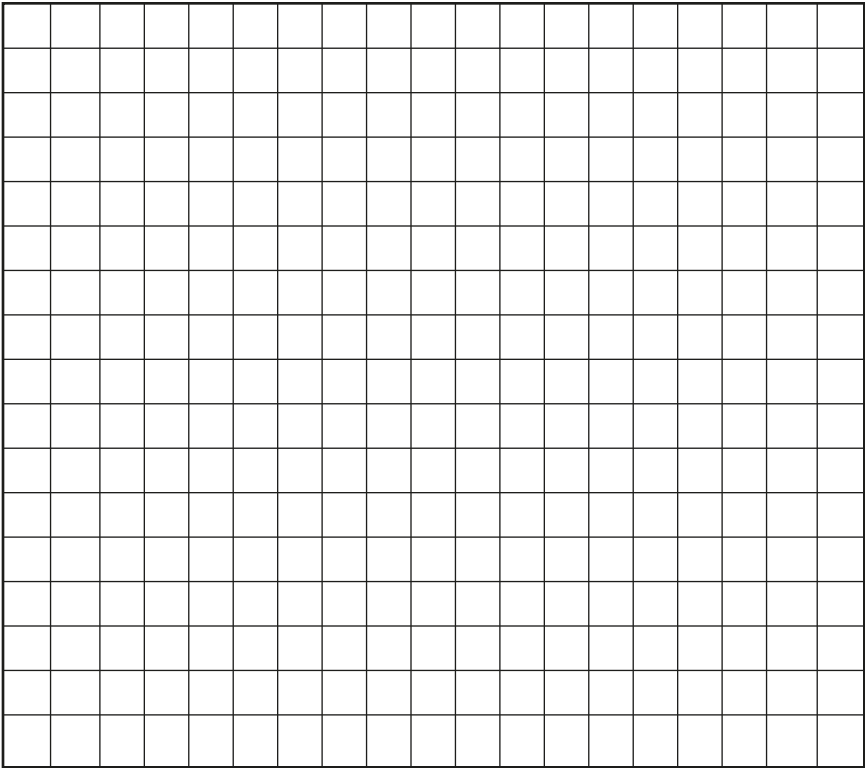

Fig. 7-18: Application data sheet (continued from previous page).

there is a choice of currents and voltages. In situations involving unusual voltages or voltage fluctuations, high form factors, or unusual and varying frequencies, special care must be exercised in selecting a motor. The power source, therefore, must be fully defined and understood before proceeding.

- 5) *Fixed Speed? Allowable Variation?* The answer to the first half of the question will usually establish whether a motor or a gearmotor is required. The variation allowable will establish the speed constant required; that is, if the motor is to be of synchronous or non-synchronous type, or if tachometer feedback or openloop control is required.
- 6) *Adjustable Speed? Universal (series wound), brush-type DC or brushless DC motors* are usually indicated if adjustable speed is required. Brushless DC motors offer excellent speed regulation plus less maintenance and greater torque-per-motor frame size than brush-type DC motors. Series motors can be adjusted over a wide speed range by means of a rheostat, adjustable autotransformer or an electronic speed control. However, due to loss in torque with decrease in voltage, the practical speed range is usually limited. Shunt-wound motors and PM motors used in conjunction with SCR or similarly controlled power sources are better suited for applications requiring relatively constant (with respect to load) but adjustable, speed over wide ranges.
- 7) *Direction of Rotation?* The National Electrical Manufacturers Association (NEMA) has established that the standard direction of shaft rotation for all DC motors, all AC single-phase motors and all universal motors shall be counterclockwise when facing the end opposite the driveshaft.

Most motor manufacturers have adopted this designation, but some, including the Bodine Electric Company, have historically considered the direction of rotation of motor and driveshafts to be that which is seen when looking at the end of the shaft, and so indicate in their literature.

Since there is inconsistency between motor manufacturers, there is always the possibility of misunderstandings which can result in motors being wound for the wrong direction of rotation. To avoid this, when specifying the direction of rotation of unidirectional motors or gearmotors, always include a point of reference. For example, in the case of a single-shafted motor, a typical specification might read: "Rotation clockwise, facing end of shaft," or in the case of a single-shafted gearmotor: "Rotation counterclockwise, facing the end of the driveshaft extension."

Motors or gearmotors with multiple shafts present special communication problems. In these cases a point of reference should be the extension that is depicted as "standard" on the catalog dimension sheet. For example, in the case of a motor, the specification might read: "Rotation clockwise, facing extension at end opposite leads," or in the case of a gearmotor: "Driveshaft rotation clockwise, facing end of left-hand extension." Use of the sketch space under Item 20 in the application form (Fig. 7-18) will help to alleviate any possibility of error in complex cases.

- 8) *Load Requirements and Conditions?* This question basically asks:
- 1) what is the power or torque requirement, and
 - 2) how is it determined.

It is quite possible that the design engineer has determined the power requirements analytically or by some

mechanical means, accomplishing the latter by the string and pulley method (Section 7.6) or by actually powering the device with a test motor. If the load were determined by use of a test motor, it is probable that tests were run at rated voltage. There is always the possibility that the test motor developed more power than was actually necessary for the application and that a motor providing less power, and quite possibly less costly, would be adequate for the application.

This possibility can best be established by employing a variable autotransformer and measuring the minimum voltage required to start and drive the load. By means of a brake test on the same or an identical motor, one can then measure the torque developed at the minimum voltage and establish the magnitude of the actual load under starting and running conditions. There is a tendency for design engineers to specify their power requirements in terms of horsepower.

It is better, in all cases, to establish the power requirements in terms of torque. This is especially true for gearmotor applications.

8a-b) *Continuous Load or Intermittent Load?* Once the magnitude of the load has been determined, we are ready to define the duty cycle as continuous or intermittent. By definition, a motor which continues to operate after it has reached normal operating (steady) temperature is operating under continuous duty conditions. Conversely, one which never reaches a steady temperature, but is permitted to cool between operations, is operating under intermittent duty conditions. Intermittent duty motors are given a time rating by the manufacturer. It can be seen, then, that the subparts of question

8a) take on vital significance since the answers determine the extent to which heat generated under load will be dissipated during the time the motor is operating at no-load or at rest.

8c) *Reversing Service?* It might seem at first that the only reason for this question is to select the winding type. While this is true, reversing service is also an important factor in the mechanical life of gearmotors, and in brush life of DC or series wound motors.

The reply to this question must be weighed with other information provided about the load to determine its relative importance. For example, if the load is inertial and must be reversed, it could produce excessive shock loads on the gear train, possibly necessitating a slip clutch on the output shaft to reduce the shock.

Basically, we should be concerned with the frequency of reversals, and whether the motor must reverse while rotating or from rest. In connection with the latter, there are some applications where the design engineer may specify "Motor must reverse in three seconds." If this is specified, the inertia of the load must also be given. (See 8i.) One would then analyze feasibility of reversing with different kinds of motors. A sample motor may need to be built to determine if the requirement could be met.

8d) *Shock Loads?* It is important to establish if shock loads exist in the application. Although we all have an intuitive idea of what shock loading is, formulating a precise definition (without resorting to mathematical terms) is somewhat difficult, and long-term testing by the customer of a drive may be required to establish the suitability or fitness of a drive for the application.

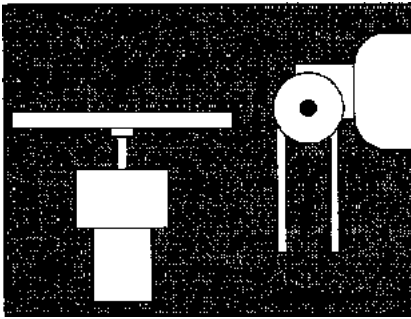

Fig. 7-19: Typical applications imposing axial and radial loads.

The important aspect of all common definitions of “shock” is that they imply a degree of suddenness and severity. The combination of these two parameters will have immense consequence in determining the overall life of a drive system. When describing a shock load condition, it is imperative to state as accurately as possible (in terms of time) the degree of suddenness and (in terms of torque) the severity to which the motor or primarily the gearmotor will be subjected.

Running a drive against a stop is the one most commonly thought of shock condition. However, since shock loading is a matter of degree, the complete load requirements of the application must be studied. Loads which vary significantly and can be classified as shock loads should be described thoroughly (with a torque vs. time diagram, if possible). Common examples of more moderate shock conditions would be clutched inertia loads or cam loads. In the case of the clutch, the amount of inertia and the time of clutch engagement should be reported on the application form. For cam loads, a dimensioned sketch of the cam on the reverse side of the form and a description of the load will greatly assist the drive manufacturer.

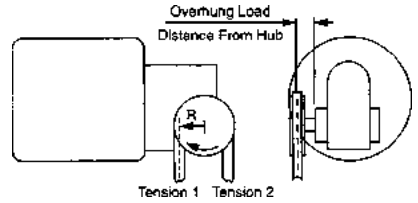

Fig. 7-20: Sketch illustrating a typical overhung load application.

An important area not to be overlooked is whether the load will be braked or reversed, or both, when driven by a gearmotor (especially one with “self-locking” worm gearing). In the case of inertial loads, such service can result in severe shock if mechanical protection devices are not employed. The method of braking (including point of application) and reversal should be described thoroughly.

The effect of shock loading on the overall life of a drive system cannot be overemphasized. Extreme care and attention should be given to this portion of the application information form.

8e) *Radial or Overhung Loads?* These are loads which are applied in a direction perpendicular to the axis of the shaft. These may be directly applied as shown in Fig. 7-19, or reaction type as shown in Fig. 7-21. Examples of the first type are loads imposed by belt or chain tensioning and loads created by supported weights such as those found in hoist applications. Examples of the second type are loads which are developed when the shaft is coupled to the load through belt or chain drives or through external spur, helical, bevel or worm gearing.

A sketch, like the one in Fig. 7-20, should be used to describe the radial loads to be expected in an application. Figure 7-20 shows an application

employing a belt and pulley coupling. Given the torque at normal operating speed (Item 8a of Fig. 7-18) and the pitch radius of the driving pulley, the driving force at the point of application can be calculated as follows:

Driving force = torque ÷ pulley pitch radius

and,

Driving force = tension 1 - tension 2

The overhung load to which the driving shaft will be subjected is determined by adding the total initial belt tension applied in a direction perpendicular to the axis of the shaft.

8f) *Axial or Thrust Loads?* These are loads which are applied in a direction parallel to the axis of the shaft. They may be directly applied as shown in Fig. 7-19, or the reaction type as shown in Fig. 7-21.

Axial fans or directly supported turntables and centrifuges are typical applications developing direct axial loads. Reaction type thrust loads are typically found in applications employing helical or worm gearing to couple the motor or reducer to the load.

In most cases, directly applied axial loads are those developed in applications where the motor or reducer shaft is vertical. In the case of plain motors, it must be known whether the shaft will be up or down, since the weight of the rotor must be taken into consideration. The thrust developed in gear reaction loads is the product of the driving force and the tangent of the external gear tooth helix angle. It is necessary, therefore, for the designer to provide information about the actual torque loading and details regarding the external worm or helical pinion in order for the axial load to be calculated.

8g) *Directly Driven Loads?* Properly aligned directly driven loads are those which present only “pure” torque loads to the motor or gearmotor driveshaft and its bearings. If radial or axial loads are present, they are carried instead by bearings in the equipment being driven, in which case the motor is usually coupled to the load by means of a flexible coupling to avoid alignment problems or, in some cases, to reduce shock.

Couplings usually employed for directly driven loads include steel sleeve, multi-jaw, jaw types with resilient inserts and universal joints. Each has its own unique characteristics and knowledge of the type of coupling to be employed is of value in determining if the motor will be properly applied.

8h) *Is the Motor Started Under Load?* This section prompts a “yes” or “no” answer, but in some unusual cases, it might be answered “sometimes.” There are many applications where the motor normally “sees” little or no load at start but, at certain points in the load cycle, will experience maximum possible starting load. For example, in an electric typewriter application, the maximum load condition normally occurs when the carriage is being shifted. Should the operator turn the machine off, or should the power plug be inadvertently pulled at this load point, the motor must be designed to develop sufficient starting torque to overcome the load when the power is restored. For applications of this type, it is useful to obtain information as to load variations expected throughout the operating cycle.

The answer to the second part of the question (“If so, what is the starting torque required?”) should be a real number expressed in oz-in., lb-in., kg-

cm, n-m, etc. This can usually be determined by the string and pulley method. (Refer to Section 7.6.)

8i) *Is Load of Inertia (Flywheel) Type?*

When the reply is "yes," we should obtain information about the actual load inertia or WR^2 (sometimes referred to as WK^2). If the information is

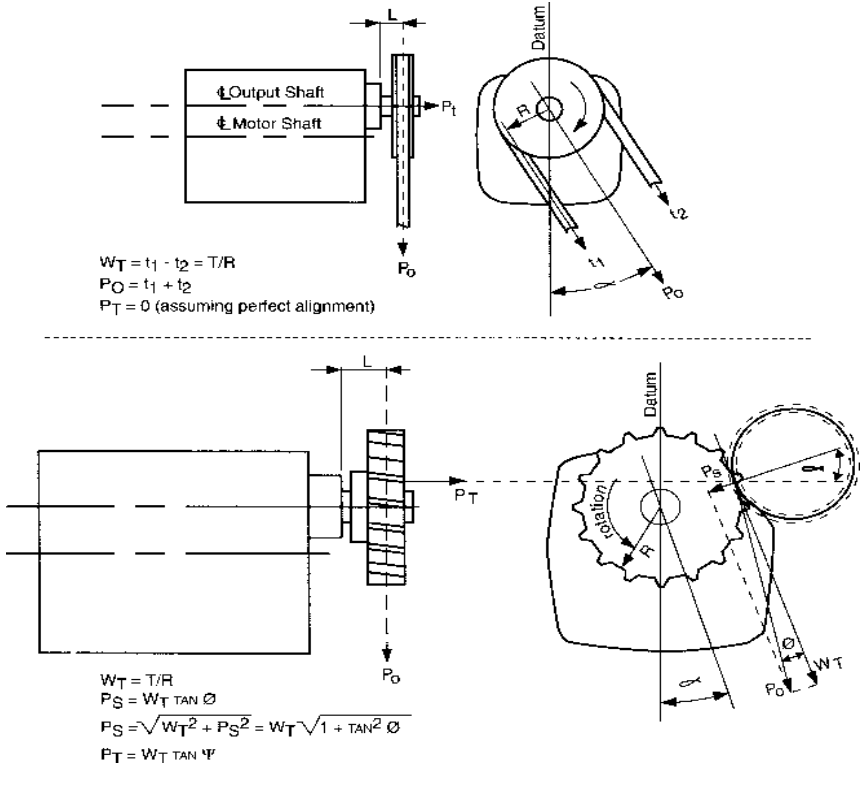

NOTE

If conditions do not permit exact measurements of t_1 & t_2 , the following are generally accepted approximation factors:

- | | |
|------------------------------|----------------------------|
| Chain: $P_O = 1.0 W_T$ | V-belt: $P_O = 1.5 W_T$ |
| Timing belt: $P_O = 1.2 W_T$ | Flat belt: $P_O = 2.5 W_T$ |
| Gear: $P_O = 1.2 W_T$ | |

NOMENCLATURE

- W_T = Tangential force
- P_O = Overhung load (force)
- P_S = Separating load (force)
- P_T = Thrust load (force)
- R = Pitch radius (length)
- T = Torque (force x distance)
- t = Belt tension (force)
- Ψ = External gear tooth helix (zero for spur gear or chain drive)
- ϕ = External gear tooth transverse pressure angle
- α = angle of force W_T along line connecting shaft centers with respect to a defined datum line on a gearhead
- L = Distance from housing datum

Fig. 7-21: Method for calculating overhung and thrust loads on gearmotors: a) for driving belts and chains (top), and, b) for driving via external spur or helical gearing (bottom).

unavailable, it may be necessary to send the device to the motor manufacturer for testing.

Load inertia information is especially important if a salient pole synchronous motor is being considered as the rotary power source. The reason is that the “pull-in” to synchronism torque capability of the motor must be great enough to overcome the WR^2 or combined inertia of the motor and the driven load.

- 8j) *Is Time a Factor in Bringing the Load Up to Speed?* This relates mostly to inertial loads which invariably use more power to start and accelerate to running speed than they do to keep running at full speed. The torque required to accelerate the load from stand-still to running speed varies inversely with the time allocated for acceleration. Therefore, it is necessary to know if there is any minimum time limit. If so, the limit should be specified here.
- 9) *Life Expectancy of Motor (Number of Hours)?* Life expectancy is extremely important in the selection of the best and most economical motor or gearmotor for the application. In addition to supplying information about total life expectancy in hours, it is important to establish the number of starts and the expected running hours over a given period of time.
- An example of manufacturer standards for life expectancy under normal operating conditions are:
- a) steady load with no shock,
 - b) continuous duty, eight hours perday, five days per week,
 - c) infrequent starts,
 - d) ambient temperature of 0°C to 40°C ,
 - e) voltage to be within 10% of nameplate rating, and
 - f) frequency to be within 5% of nameplate rating.

In addition, altitude limits are sometimes specified or implied. The life of most motors may be greatly affected by any deviation from normal operating conditions.

Temperature is particularly important, as motor life expectancy is a function of total temperature. Insulation, lubricant and seals are all affected by temperature. This is illustrated by the following.

- 1) As a general rule, ball bearing or gear lubricant life is halved for every 25°F (approximately 14°C) increase in temperature. Heat will eventually degenerate most lubricants and seals, leading to leakage, increased friction and extra maintenance.
- 2) Generally, the motor insulating life is halved for each 10°C increase in total temperature.

Therefore, it is apparent that temperature has a direct bearing on the life of a given motor. When considering life expectancy, we should cross-reference the following application considerations that directly affect the motor’s operating temperature:

- a) bearings,
 - b) lubricants,
 - c) duty cycle,
 - d) radial load,
 - e) axial load,
 - f) mounting,
 - g) enclosure,
 - h) ambient temperature,
 - i) ventilation, and
 - j) electronic controls.
- 10) *How Frequently Will the Motor be Serviced?* Answers to this question in conjunction with information concerning life expectancy, duty and ambient temperature are important in selecting the best bearing and gear lubricant. Similarly, brush selection, in the case of series wound or DC motors, is dependent to a degree upon the service anticipated. If

cleaning is seldom or not expected, a totally enclosed motor may be necessary, depending on the environment.

- 11) *Space and Weight Limitations?* If space is limited, this becomes a very important consideration. Show the maximum space envelope (using a sketch) and indicate how and where the load should be coupled to the motor or driveshaft. The sketch should also show any space restrictions caused by interference with other components.

In analyzing an application's space and/or weight limitations, the associated cost elements must be recognized. Here are a few general areas which might be affected.

- a) Where a reduction in speed is needed, an integral speed reducer motor should be considered. By combining the motor and speed reducer in one unit, cumbersome and complicated speed reduction transmissions can be avoided. This alone may resolve the space problem.
 - b) If space and weight for the motor is figured too closely, a totally new redesigned special purpose motor may be required. This could involve extensive engineering and special tooling. One of the most frequent application mistakes is to ignore the potential need for more space to accommodate a larger motor if one is required at a later time.
 - c) If the design does not afford sufficient motor ventilation to keep the temperature rise within tolerable limits, a larger and more expensive motor may be required.
- 12) *Motor Mounting?* A sketch should be used if standard mounting cannot be adapted. The standard mounting Posi-

tion is usually described in a dimension diagram supplied by the manufacturer.

In the "standard" position, the axis of the motor lies in a horizontal plane. For gearmotors in standard mounting position, the axis of the output driveshaft also lies in a horizontal plane. The choice of motor mounting may depend on motor design, operating conditions, space requirements and life expectancy. Factors to be considered include:

- a) sleeve vs. ball bearings,
- b) oil vs. grease lubrication,
- c) ventilation,
- d) care and servicing, and
- e) special modifications.

In all sleeve bearing motor and/or gearmotor applications, the mounting must be specified. If the unit and/or the output driveshaft is rotated from horizontal to another position, almost without exception a different lubrication arrangement is required (sometimes at additional cost).

The nature of the differences will depend largely upon the choice of mounting and/or whether the application requires an oil-lubricated or grease-lubricated gearmotor.

Special lubrication arrangements can include new location of drain, fill, vent and level indicators, or special oil seals. Mounting the gearhead above the motor is not recommended and should be avoided because of the risk of lubricant leakage down into the motor if a seal fails or wears out. Lubricant leakage into the motor can cause motor failure with additional hazards to personnel and equipment.

- 13) *Temperature Surrounding Motor?* This is the "ambient" temperature and directly affects a motors life expectancy.

Most locations expose a motor to the normal operating range (0°C to 40°C or 32°F to 104°F). Temperatures above or below this range may create lubrication problems in both motors and garmotors or insulation problems.

Temperatures lower than normal may require special considerations in order to provide adequate starting torque due to stiffening of bearing and gear lubricants. Also, a time lag may exist in reaching operating speed, which could affect the performance of the driven equipment.

Temperatures higher than normal present lubrication and sealing problems because of viscosity changes in the lubricant. In addition, the maximum operating temperature for the winding insulation system is established on the basis of the motor type and insulation class.

14) *Is Equipment Designed to Provide Adequate Ventilation to the Motor?*

A motor in a suitable ambient temperature may still overheat if the equipment confines the motor in such a way that its generated heat cannot be dissipated. The ambient temperature in close proximity to the motor should never exceed the nameplate value (normally 40°C).

A motor external to the equipment in a suitable ambient temperature is exposed to circulation of free air and normally would have adequate ventilation. A motor housed within the equipment needs ventilation. Depending upon the degree of confinement, circulating free air may be provided from vents in the equipment housing, or by forced ventilation.

15) *What is the Condition of the Air Surrounding the Motor?* Dust, grit, humidity and acid fumes can damage motors. Airborne particles may clog

ventilation openings, preventing sufficient heat transfer. Moisture and fumes may deteriorate motor components. The answer to this question helps define the type of enclosure, environmental treatment, shaft materials and lubricants required.

Open, ventilated motors are suitable for clean, dry locations where cooling air is not restricted. Enclosed products are suitable for dirty, damp locations. For outdoor use, wash downs, etc., enclosed products must be protected by a cover while still allowing adequate air flow.

In open-type motors, sparking of starting switches in AC motors so equipped, and of brushes in commutator-type motors can be expected during normal operation. In addition, open-type enclosures may eject flame if the insulation fails. Therefore, avoid placing open-type motors, garmotors, or controls in the presence of flammable or combustible materials.

Most totally enclosed products are not explosion-proof. Explosion-proof motors, garmotors and controls should be used for hazardous locations (flammable/explosive gas, vapor, dust). When dealing with hazardous locations, an approved explosion-proof product is the recommended approach. Exceptions are allowed by the National Electrical Code. NEC and NEMA safety standards should be studied thoroughly before exercising this option.

Moisture increases the electrical shock hazard. Open-type motors should always be protected from moisture. Totally enclosed motors will reduce the hazard if all openings are sealed.

16) *Shaft End Play Restrictions?* Standard “end play” (or axial shaft freedom) of rotor (or armature) shaft and gearmotor driveshaft is controlled by the manufacturer during assembly. Some typical end play specifications are as follows.

On sleeve bearing supported shafts:

- a) Soft spacing washers limit motor and armature end play to within 0.005 to 0.020 inch.
- b) Reducer driveshafts are limited to within 0.005 to 0.020 inch end play by means of hardened washers of varying thickness.

On ball bearing supported shafts:

- a) The ball bearings of rotors or armatures are preloaded by means of spring-type washers to provide quiet bearing operation under cold and normal operating temperatures. This results in essentially no free end play of the shaft unless a sufficient axial force is applied.
- b) The ball bearings of the secondary shaft and the driveshaft of many gearmotors are spaced to a minimum of end play by flat steel washers of various thicknesses as required.

On needle bearing supported shafts:

- a) In this type of bearing, the drive shaft acts as the inner race of the bearing and consequently is similar in free end play to that of a sleeve bearing. The sections of the shaft in the journal area are hardened. End play is typically limited to within 0.005 to 0.020 inch by means of spacer washers.

In rare cases, requests are made for more closely held end play than standard tolerance for sleeve bearing

supported shafts. Any limited end play requirement would necessitate special gauging fixtures for assembly and final inspection checking. It is not practical in production to space a sleeve bearing assembly to zero end play. In subfractional horsepower motors, added frictional losses resulting from a zero end play tolerance could mean the difference between success and failure. Additionally, within a short period of time (providing the motor does not overheat and fail), the washers or bearing faces will wear away and end play will develop regardless of precautions.

17) *Shaft Dimensions if Other Than Standard?* This detail on the application form. causes little or no problem unless a designer wants a special feature such as a cross-drilled hole located “x” inches from the bearing hub or centered to something less than up to .006 TIR. The normal method of dimensioning the location of a cross-drilled hole, a cross-milled flat or the shoulder of a reduced diameter on a shaft extension is from the end of the shaft, and the normal tolerance is ± 0.005 inch (0.196 mm). Ball bearing supported shafts have no free end play and the normal tolerance of the extension is ± 0.032 inch (0.8 mm). When checking the length of a sleeve bearing supported shaft, the measurement should be made with the shaft pulled out. Under these conditions, the tolerance is the same as above.

18) *Electrical Leads?* This item offers a choice of connections from the motor to the power source. Popular lead materials generally consist of individually tinned copper strands. Insulation is polyvinyl chloride or x-linked. polyethylene. If the designer requires something different, the number of strands and the

type and color of insulation should be included. Of course, the motor manufacturer's standard leads are the most economical choice.

19) *Give Additional Requirements Not Covered by the Above Data Such as UL, CSA, Braking, Overload Protection, and Quietness.*

Considering the unlimited application possibilities involving small motors and gearmotors, it would be impossible to cover every application consideration in one questionnaire. This space provides information for any special requirements not covered in the form. A continuation sheet should be attached if needed. The following comments apply to some of the specific examples listed.

- a) *UL, CSA, etc.* = Many applications require compliance with one or more of these organizations' standards. Their specific requirements should be made known to the motor manufacturer at the outset. At times, there are charges to the motor manufacturer for "third party" approvals.
- b) *Braking* = Frequently, the power transmission must be braked or stopped by some mechanical or electrical means. Complete data describing the method of braking required is essential (for example, frequency of braking time required to stop), and whether or not holding torque must be present after the motor has been stopped.
- c) *Overload Protection* = This may be a requirement of the testing or standards writing organization (as in No. 19a.) Four basic types of overload protective devices are normally used with fhp motors: fuses,

overload relays, thermostats and inherent overheating protectors. See Section 7.4. Fuses and relays are sensitive to motor current only. Thermostat devices, usually in direct contact with motor windings, respond to temperature only. Inherent overheating protectors respond to the total heating effect whether it is caused by temperature alone, current alone or the combined effect of both. Caution must be exercised if "automatic" reset protectors are used = they can reset without warning and be hazardous to personnel.

- d) *Quietness* - This is a complex problem including both mechanical and electrical design. See Section 7.3.

Although the foregoing is by no means a complete analysis of all the factors, it should provide a guideline for motor selection. It should again be stressed that the more time spent on this planning phase to provide the motor manufacturer with accurate, relevant information about the device to be driven, the easier it will be to match the right motor to the application.

Applying fhp Gearmotors

When gearmotors are specified, there are many factors to consider in addition to those mentioned previously. This is due to the gearing and the effects it has on other parts of the system.

Inertial, Reversing and Overrunning Loads: Inertial loads with high reduction ratios often produce extreme torque multiplication between input and output shafts.

The motor and gearhead must be sized to sustain the torque developed when starting or stopping this type of load. Reversing an inertial load should be avoided unless the gearing is disconnected from the load, and the load braked before reversal.

Overrunning loads can be inadvertently imposed on the gearhead. For example, power failure or disconnect on an elevating device driven by a gearmotor can cause the load to drive the gearmotor in reverse. If backdriving of a gearmotor is contemplated, the manufacturer should be contacted since many gearheads can be easily damaged by backdriving.

Service Factors for Gear-
ing: Service factors are correction factors which compensate for nonstandard load conditions and are applied to torque, overhung and thrust load ratings of gearing. These factors compensate for variable and shock loads. The service factors are not as well defined for gearmotors below approximately 1/8 hp as they are for larger units, and judgement should be exercised in their application. Unfortunately, there is no common agreement among small motor and gearmotor manufacturers to the magnitude of various service factors.

Service factors, developed through experience, are useful for estimating the severity of the actual duty, compared with average duty. The service factors (Fig. 7-22) as indicated for classes of service defined, are provided as application guidelines. They should be multiplied by the uniform steady, or average torque of the load resulting in "equivalent required torque."

$$\text{Equivalent required torque} = \text{service factor} \times \text{uniform steady torque.}$$

Equivalent required torque should not exceed rated torque of the gearmotor.

Type of Load	8 Hr.	24 Hr.
Uniform Steady	1.0	1.5
Light Shock	1.5	2.0
Moderate Shock	2.0	2.5
Heavy Shock	2.5	3.0

Fig. 7-22: Service factors for various types of loads.

Figure 7-21 provides formulas for calculating overhung and thrust loads on gearmotors. The following application guidelines also apply to the classification of load type.

Uniform Load ≡ A load which does not vary appreciably during operation or changes gradually. Blowers or chart drives would be in this category.

Moderate Shock ≡ A load which varies significantly during operation or is applied rapidly. Clutched loads of low inertia or cam loads would likely be in this category.

Heavy Shock ≡ A load which varies greatly in a relatively short time. Inertial loads braked or reversed through nonlocking gearing would be in this category.

Extreme Loads Not Covered ≡ An impact load or high speed, high inertial load driven by self-locking gearing cannot be covered by service factors and must be referred to the motor manufacturer.

No matter how well a motor or gearmotor is constructed, improper application can result in poor performance or complete failure. The foregoing illustrates the proper approach in the evaluation of the load to be driven by a motor or gearmotor. To aid in the selection procedure, most manufacturers can provide a selection worksheet which serves as a convenient checklist for both the customer application engineer and the manufacturer.

7.9 SAFETY

The use of electric motors and generators is potentially hazardous. The degree of hazard can be reduced by proper design, selection, installation and use, but hazards cannot be completely eliminated. Hazard reduction is the joint responsibility of the user, the manufacturer of the driven or driving equipment and the motor manufacturer.

Many motors, gearmotors and speed controls are designed and manufactured to comply with applicable safety standards, and in particular with those issued by ANSI, NEMA, UL and CSA. In addition, many overseas standards are being followed. In particular, IEC (International Electrotechnical Commission) standards are gaining influence.

Furthermore, many products are “third party approved” with respect to construction. Motors, gearmotors and controls recognized by UL are designated with a code on their nameplates. The use of codes is unique to each manufacturer. Each manufacturer must be consulted as to the status of their “third party approval,” if any.

However, since even well-built apparatus can be installed or operated in a hazardous manner, it is important that safety considerations be observed by the user. With respect to the load and environment, the user must properly select, install and use the apparatus. For guidance on all three aspects, see Safety Standards Publication No. ANSI C51.1/NEMA MG-2*.

Selection

Before proceeding with the installation, the user should review the application to confirm that the proper drive has been

selected. This should be done after thoroughly reading and understanding Section 7.8 and all applicable safety standards. If in doubt, contact the manufacturer.

Selections or application suggestions made in this Handbook are intended only to assist the reader. In all cases, the reader is solely responsible for determining a product’s fitness for application or use.

Installation

It is the responsibility of the equipment manufacturer or the person installing the motor to take diligent care in installing it. The National Electrical Code (NEC), sound local electrical and safety codes, and when applicable the Occupational Safety and Health Act (OSHA) should be followed when installing apparatus to reduce hazards to persons, other equipment and property.

Inspection

Examine the motor for damage from shipping before connecting. Do not attempt to turn the output shaft of a gearmotor with an externally applied torque arm.

Connection

Follow the nameplate for voltage, frequency and phase of power supply. See the accompanying wiring diagram for connections and rotation (and capacitor, if required). Make sure that the motor, gearmotor or control is securely and adequately grounded. **Failure to ground properly may cause serious injury to personnel.** (If the wiring diagram shipped with the drive unit is lost or missing, contact the manufacturer.)

*Standards Publication No. ANSI C51.1/NEMA MG-2 Safety Standard for Construction and Guide for Selection, Installation, and Use of Electric Motors and Generators is available from the National Electrical Manufacturers Association, 2101 L Street, NW, Washington, D.C. 20037, USA.

Wiring

For wire sizes and electrical connections, refer to the National Electrical Code (NEC) article covering motors, motor circuits and controllers, and/or applicable local safety codes. If extension cords are used, they should be kept short for minimum voltage drop. Long or inadequately sized cords can cause motor failure, with hard starting loads when current draw is at its highest.

Before starting the motor:

- 1) Check all connections and fuses.
- 2) Be sure keys, pulleys, etc. are securely fastened. **Proper guards should be provided to protect personnel from hazardous rotating parts.**
- 3) Other mechanical considerations include proper mounting and alignment of products and safe loads on shafts and gearing. Do not depend on gear friction to hold loads.

When starting the motor:

- 1) Test-start the motor or gearmotor in an unloaded state. (Because of possible reaction torque, the drive should be securely mounted when started, even when unloaded.)
- 2) If the drive unit does not start promptly and run smoothly, disconnect it at once.
- 3) If you are unable to correct the problem, contact your purchase source or the manufacturer, describing the trouble in detail. Include the serial number, type and other nameplate data. Do not dismantle the product unless authorized by the manufacturer; removing screws voids many warranties.

Operating

The chance of electric shocks, fires or explosions can be reduced by giving proper consideration to the use of grounding, thermal and overcurrent protection, type of enclosure and good maintenance procedures.

The following information supplements the foregoing safety considerations. This information is not intended to be all-inclusive, and other applicable sections of this *Handbook* as well as local and national safety codes should be referenced and understood before operating electric motors.

- 1) Do not insert objects into motor ventilation openings.
- 2) Sparking of starting switches in certain AC motors, and of brushes in commutator-type DC motors, can be expected during normal operation. In addition, open-type enclosures may eject flame in the event of insulation failure. Therefore, take all necessary precautions to avoid, protect from or prevent the presence of flammable or combustible materials in the area of open-type motors, gearmotors and controls.
- 3) When dealing with hazardous locations (flammable or explosive gas, vapor, dust), make certain that an approved, explosion-proof or dust-ignition-proof motor is specified.
- 4) When dealing with any environment that is unusual such as high humidity, high altitudes, low humidity, exposure to weather, etc., make certain that the proper motor has been specified. Refer to Section 5.5 for environmental classifications of motors.
- 5) Moisture will increase the electrical shock hazard. Special care should be exercised whenever moisture is present to avoid electrical shock.
- 6) Products equipped with thermal protectors are required to be labeled “

Thermally Protected.” If severe overloading, jamming or other abnormal operating conditions occur, such heat-sensitive protectors operate to open the electric power supply circuit. Motors/gearmotors with automatic thermal protectors must not be used where automatic restarting of the drive unit could be hazardous, in that clothing or parts of the human body could be in electrical or physical contact with a machine that starts unexpectedly when the thermal protector cools down. “Manual reset” protectors or suitable electric supply disconnect devices/procedures should be used where such hazards could be created.

- 7) Motors/gearmotors which employ capacitors can develop more than name-plate voltage across the capacitor and/or capacitor winding (depending upon design). Suitable precautions should be taken when applying such motors.
- 8) Abnormal conditions, such as cut-out switch failure, or partial winding failure due to overheating, etc., can, on rare occasions, cause certain types of AC motors / gearmotors to start in a direction reverse from normal. The chances are highest when the motor’s rotor “sees” a relatively light load. One-way clutches or similar devices are advisable if such a remote risk is not tolerable in the intended application.
- 9) Some additional considerations in applying speed controls include:
 - a) Chassis controls should be properly guarded or enclosed to prevent possible human contact with live circuitry.
 - b) Individual manufacturer’s specifications should be checked, but in general, the ambient temperature should not exceed 40°C (104°F) for encased-type controls. For chassis-type controls, maximum permissible

ambient temperature is usually 50°C (122°F.)

- c) As in the case of motors / gearmotors, controls must be properly grounded to prevent serious injury to personnel.

Maintenance

Different motors require different types of maintenance and care. Specific maintenance requirements are outlined in Section 7.10.

For general safety purposes, however, the area around an electric motor should be kept free from dust and dirt or from obstructions which could interfere with proper ventilation.

In addition, before servicing motors or gearmotors employing capacitors, **avoid any contact with the capacitor terminals until it has been discharged.** The capacitor should be discharged in accordance with safety instructions provided with the motor. If instructions are not available, contact the motor manufacturer for more information.

7.10 CARE AND SERVICING

With the availability of new and better insulating materials and the extensive use of grease-lubricated (“lubricated for life”) ball bearings, quality electric motors have become more reliable and maintenance-free than ever before. However, in order to help obtain the best service from an electric motor, a few helpful guidelines are given below.

IMPORTANT: Before servicing or working on equipment, disconnect the power source. (This applies especially to equipment using automatic restart devices instead of manual restart devices, and when examining or replacing brushes on brush-type motors/gear - motors.)

Regular Inspection and Maintenance

Small motors usually operate with so little trouble that there is a tendency to neglect them. Wherever possible, most motors should be inspected twice a year to detect wear and correct any other conditions which might lead to excessive wear or premature failure. Special attention should be given to the following common causes of motor failure.

Changing Load Conditions:

Sometimes additional friction develops gradually within the driven machine and thus imposes an overload on the motor which will cause overheating. Overload conditions should be promptly corrected. It is also important to protect motors with properly rated fuses. If overloads are likely, then an overload protector should be specified when selecting the motor. See Section 7.4, Thermal Protection.

Motor and Load Alignment:

When the motor shaft becomes misaligned with its load, damage to both the shaft and the bearings can occur. In some instances, the driven machine may also be damaged.

Excessive Overhung

Loads: Belt and pulley and other similar drives which subject the motor shaft to radial (overhung) loads must not be adjusted too tightly or placed too far out on the motor shaft. Otherwise, they can cause excessive bearing wear and/or shaft failure.

Excessive Axial Thrusts: Loads and couplings must be connected so that excessive axial pressure is not exerted on motor bearings that will cause premature failure.

Load Must Not Lock on Gearmotors: A torque-limiting clutch should be provided if there is a possibility that the output shaft might be locked or jammed.

Such locking quickly builds up tremendous forces within the gearhead, stripping gears or damaging other components. If a flywheel is necessary, consideration should be given to attaching it to the high speed motor shaft extension. If a flywheel or high inertia load is used on a slow-speed gearmotor shaft, it tends to keep the shaft turning after the motor has stopped, causing the same effects on a gearhead as locking the driven shaft.

Inadequate Wiring: When installing a new motor or transferring a motor from one installation to another, it is advisable to check the wiring. Adequate wiring (depending on the voltage, current, environment and distance from the power source) should be used to feed electrical power to the motor. (Consult the National Electrical Code.) Replacement of old, obsolete wiring will prevent future breakdowns and possible hazards to personnel.

Contamination: Next to overloading or abuse, contamination is probably the most common cause of motor failure. Ordinary dust and dirt can restrict ventilation and coat motor windings, cutting down on heat dissipation. This clogging can lead to continuous overheating and eventual insulation breakdown. Dirt can also cause wear in such moving parts as bearings.

Moreover, dirt which is electrically conductive in nature can cause grounding or shorting of motor windings. Contaminants can cause additional problems in motors having brushes and commutators or internal centrifugal switches. Therefore, if it is not possible to keep the motor reasonably clean, a totally enclosed motor should be considered.

Worn Brushes: Brushes are expected to wear, but they should not wear excessively. The wear rate of brushes is dependent on many parameters (armature speed, amperage conducted, duty cycle,

humidity etc.). For optimum performance, brush-type motors and gearmotors need periodic user-maintenance. The maintenance interval is best determined by the user. Inspect brushes regularly for wear. Periodically remove carbon dust from the commutator and inside the motor. This can be accomplished by occasionally wiping them with a clean, dry, lint-free cloth. Do not use lubricants or solvents on the commutator. If necessary use No. 0000 or finer sandpaper only to dress the commutator. Do not use solvents on a nonmetallic end shield or other motor parts if the product is so equipped.

Whenever a brush is removed for inspection, care should be taken to put it back in its original position. Changing brush alignment or position will result in poor contact between brush and commutator surfaces. This can cause excessive sparking with accompanying loss of power and damage to both the commutator and brushes. Brushes worn to a length less than 1/4 inch (7 mm) should be replaced with the same brush type.

Rapid wear of brushes is a symptom of trouble or misapplication. Rapid wear after a period of successful commutation may indicate that the commutator is badly worn. Resurfacing of the commutator may be necessary and should be performed by a qualified service shop or returned to the service department of the manufacturer.

Lubrication: Under normal operating conditions, the relubrication of sleeve bearings, ball bearings and gearboxes should be performed according to the manufacturer's recommendations. Under more severe conditions (higher ambients or increased exposure to contaminants), shorter service intervals should be established through frequent user-inspections. A word of caution: excessive oiling can do more harm than good if not restricted to a specific area. Excess oil can contaminate

windings, commutators and internal switches.

Ball Bearing Lubrication:

Ball and roller bearings require only small amounts of lubricant. Calculations show that 1/1000 drop of oil will lubricate all the surfaces of a 10 mm bearing. For ball bearing lubrication in electric motors, grease is generally preferred over oil for long maintenance-free service. This is due to the availability of improved ball bearing greases, simplified bearing housings and elimination of the "human error factor" which is frequently responsible for too much, not enough or the wrong kind of lubricant. Prelubricated bearings and the elimination of grease fittings help improve ball bearing life.

Premature bearing failures are caused by one or more of the following conditions:

- 1) foreign materials from dirty grease or ineffective seals,
- 2) grease deterioration due to excessive temperature or contamination, and
- 3) overheated bearings resulting from over-lubrication or overload.

Some danger signals are:

- 1) a sudden increase in the temperature differential between the motor and bearing,
- 2) running a gearmotor at temperatures higher than that recommended for the lubricant. The rule of thumb is that grease life is halved for each 25°F increase in operating temperature, and
- 3) an increase in bearing noise, accompanied by a bearing temperature rise, indicating a serious bearing malfunction.

Sleeve Bearing Lubrication:

Lubricants are used with ball or roller bearings to dissipate heat, prevent rust and prevent foreign matter from contaminating the bearings. Sleeve bearing lubricants, on

the other hand, serve a different purpose. The lubricant must actually provide an oil film that completely separates the bearing surface from the rotating shaft member and ideally, eliminates metal-to-metal contact.

Because of its adhesion properties and its viscosity (or resistance to flow), oil is “dragged” along by the rotating shaft of the motor and forms a wedge-shaped film between the shaft and the bearing. See Fig. 7-23. The oil film forms automatically when the shaft begins to turn and is maintained by the motion. The rotational motion sets up pressure in the oil film wedge which, in turn, supports the load. This wedge-shaped film of oil is an absolutely essential feature of effective, hydrodynamic sleeve bearing lubrication.

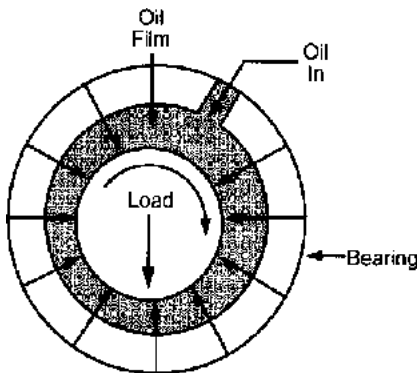

Fig. 7-23: Oil film in a hydrodynamic sleeve bearing.

Without it, no significant load can be carried without subsequent high friction loss, heat generation and resultant destruction of the bearing and / or shaft. When an adequate oil film is maintained, the sleeve bearing serves as a guide to accomplish shaft alignment. If the oil film fails, the bearing may function as a temporary safeguard to prevent damage to the motor shaft and other rotating members.

Good lubricants are essential to low maintenance costs. Top grade petroleum-based oils are recommended as they are substantially noncorrosive to metal surfaces. They are free from sediment, dirt and other foreign materials, and are stable with respect to heat and moisture. Their performance-to-cost ratio is very good.

An oil film consists of layers. The internal friction of oil, resulting from the sliding action of these layers, is measured as viscosity. The oil used should provide enough viscosity to prevent wear and seizure at ambient temperature, low speeds and heavy loads for any given application. Relatively light oils are recommended for use with fractional horsepower motors since they offer minimal internal friction, permit fuller realization of the motor's efficiency and minimize the operating temperature of the bearing.

High ambient and operating temperatures have a destructive effect on sleeve bearings lubricated with standard temperature range oils because the bearing operates at temperatures beyond the oil's capability. Such destructive effects include reduction in oil viscosity, an increase in corrosive oxidation products in the lubricant and a reduction in lubricant quantity. Special oils are available for high temperature and low temperature motor applications. The care exercised in selecting the proper lubricant for the expected extremes in bearing operating temperatures will have a decided influence on motor performance and bearing life.

Although sleeve bearings are less sensitive to a limited amount of abrasive or foreign materials than ball bearings, good maintenance practices recommend that oil and bearings be kept clean. In very small motors, dirty or insufficient oil can add enough friction to cause the bearings to seize (especially after cooldown). Frequency of oil changes will depend on local

conditions. A conservative lubrication and maintenance program should call for periodic inspection of the oil level and cleaning and refilling with new oil every six months.

NOTE: Sleeve bearing motors may tend to lose their oil film when stored for extended periods (one year or more).

Lubrication of Gearmotors

Oil provides the best combination of lubricating properties for gearmotors and is nearly always used in 1/10 hp and larger gearmotors designed for industrial service. Long service life (over 10,000 hrs.) requires a circulating fluid lubrication system.

All lubricants minimize friction, resulting in lower heat generation and load support. The fundamental characteristic of oil is its free flow and constant presence at the tooth surfaces of a gearhead during operation, thereby providing a consistent and continuous lubricating film under load.

The lubricant used in parallel shaft gearmotors (which usually employ spur or helical gearing) is relatively less critical than for right angle worm-gear types. Usually, a straight mineral oil suffices if the proper oil level is maintained. Some fhp gearmotors use hydraulic-type oils to decrease gear-shaft or journal wear.

Right angle gearmotors with worm or other types of sliding contact gearing require careful attention because the lubricants reach higher operating temperatures due to lower inherent efficiency. ("Inefficiency" is converted into heat which is absorbed by the lubricant.) Such lubricants generally have higher viscosity and contain protective additives.

Despite its advantages, oil is not commonly used in smaller gearmotors because of sealing problems. Smaller

garmotors characteristically do not have large gasket surfaces and may not have sufficient power to withstand the increased friction of a contact seal on the rotor shaft. Therefore, grease is used as a compromise in most small gearmotors under 1/4 hp (186.5 watts).

When compared with oil, grease provides less consistent lubrication to the gear teeth under load. Grease does, however, provide flexibility in mounting and minimizes the risk of leakage. Grease also eliminates periodic visual oil level inspections. The use of "stiff grease" eliminates the need for vent hole shipping plugs and their subsequent removal at the final destination. However, if a semi-fluid grease is used, vent hole plugging will be required to prevent leakage during shipment.

Grease requires a shorter service interval, primarily because of reduced lubricant circulation. Wear of the gear train parts is invariably higher when grease is used as a lubricant and the rate of wear increases as stiffer greases are used. Moderate life (approximately 2,000 hrs.) can be achieved with grease lubrication in a well-designed gearhead enclosure.

Relubrication: Oil relubrication under normal operating conditions primarily involves maintaining the oil at a recommended and indicated level. Loss of oil by evaporation or leakage is minimal over long periods of time under normal conditions which lengthens the relubricating cycle for an oil-lubricated gearmotor.

Relubrication periods for greaselubricated gearmotors are shorter and require complete removal of the old lubricant in the gear housing, proper cleaning of the residue and replenishing with the recommended quantity and type of grease (manufacturer's recommendation should always be followed). With proper maintenance and loading, life of the grease in the gearmotor under normal conditions of operation can

be appreciable. Manufacturers take careful steps to match the lubricant with the elastomers used in the oil seals as well as the requirements of the gearing and bearings in a particular gearmotor design.

Operating Temperature: Lubricant life in gearmotors is directly dependent on temperature. Generally, within the normal operating ranges, lubricant life doubles for every 25°F decrease in temperature.

Gearmotors operating in high or low ambient temperature ranges require special lubricants or lubricating systems. Gaskets, motor insulation and lubricant life may be seriously affected by temperature extremes. When other than normal ambient temperatures (0° to 40°C or 32° to

104°F) are expected, the gearmotor manufacturer should be consulted.

Mounting Considerations:

Distribution or circulation of gear housing lubricant is critical to gearhead life. Splash or special oiling gears are effective methods of oil lubrication. Grease cannot be circulated in this manner, however. So in cases where bearings and gears must be lubricated with grease, felt wicks are often used to transfer oil from the grease to the bearings. In other designs, gears are grease-lubricated and the bearings are externally oil-lubricated.

Special applications which involve rotating a gearmotor about an axis, or tilting it periodically, will require modified sealing and venting arrangements to prevent lubricant leakage. The special mountings, modified castings, additional oil seals or special lubrication systems will add to the cost.

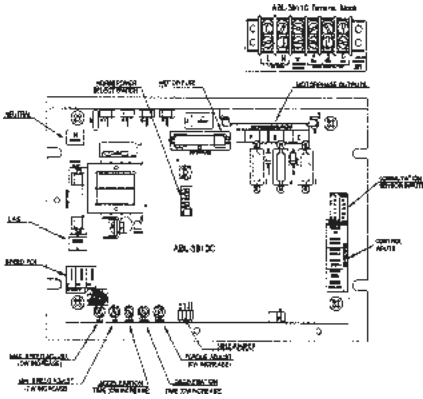

Motor Controls

Although some applications simply use a motor to drive a load at a constant or relatively constant speed (up to motor nameplate rating), most applications require some type of control device to adjust motor speed, sometimes from zero to speeds above rated. Other situations require velocity, torque and position control. The type and degree of control capability needed is determined by the application and by the type of motor used.

Up to this point in the *Handbook*, we have discussed motor theory, types and construction in a fairly straightforward manner. When discussing motor controls, however, it soon becomes obvious that there is an extremely wide range of control methods available today, ranging in complexity from the simple series rheostat to sophisticated electronic controls. The range of controls can be extended further with the addition of feedback transducers such as encoders and tachometers, which allow position and speed to be controlled quite accurately. In addition, refinements in motor technology such as brushless DC and improvements in stepper motor construction have increased motion control options even

further. These improvements are being driven by industry demands for motion control accuracy and by the need to develop more torque from a smaller motor frame size. As automation and control systems increase in number and complexity, new demands for improved performance will continue to be placed on motor and control manufacturers.

In the following sections, we will discuss the many aspects of motion control as they apply to a variety of control systems and motor types. The reader should be aware that choosing a motor control method is simply another form of problem solving. The more specifics you know about the problem, the simpler it will be to select a control method.

Certain criteria such as the power source (AC or DC), the degree of control required, the system controller type, the process you need to control, and your budget will all affect your decision. An understanding of these criteria will also allow you to narrow your focus on a particular type of motor and control very early in the process, making the decision easier.

8.1 MOTION CONTROL SYSTEMS

No discussion of motor controls would be complete without a basic understanding of the larger world of motion control systems. In order to select the most appropriate motor and control method, the designer must know what role the motor will play in the total process control system. If the system is controlling a number of similar processes, such as a series of conveyors that transport a relatively constant load on a continuous basis, then the motor selection and motion control method may be quite straightforward. If the motor must drive varying loads at a constant speed, or at speeds that must be synchronized with other processes, or if precise positioning is needed to perform a process, then motor and control selection becomes more demanding.

In complex process control systems, the system control and the motor control must be considered as well as the interface between the two.

Process Types

Process control systems, as the name implies, are used to control processes. This could be a batch process such as mixing ingredients in a food processing plant or mixing chemicals used in paint production. In either case, a specific number of individual steps are performed to get a batch of raw materials prepared for a process that is performed on the entire batch.

Another type of process is the continuous process where raw materials enter one side of a system and a fabricated or finished product exits the other side. A web printing press is an example of a continuous process. The blank paper is fed from a roll through the printer heads where ink is applied, then into an ink dryer, and finally through a variety of finishing machines that

fold, bind and cut the continuous web into finished printed booklets.

Discrete processing requires a series of precisely sequenced events to occur in order to produce a finished product. A cellular manufacturing operation where a piece of raw metal stock is placed in a machine which sequentially bores or drills holes (on one or more axes), taps the holes with varying thread sizes, and performs other similar functions to produce a finished subassembly is an example of discrete processing.

Control System Components

Most control systems consist of similar functional elements that are used to regulate the flow of materials through the system and to control the timing and sequencing of events or processes.

System Controller: The system controller provides the intelligence for the process control system. It may be a programmable logic controller (PLC), a microprocessor, an analog computer or a series of relays. Its primary function is to act as the system's timekeeper and traffic manager so that all of the functions occur at the right time and in the right order.

Actuators: Electromechanical actuators convert electrical power to some form of physical action. Motors are actuators. They can accept a control signal and move a conveyor belt to transport material to the next process. They can turn a shaft a set number of degrees to position a product for a specific operation to be performed on it. They can be used for intermittent or continuous processes depending on the type of motor and the requirements of the application. Other examples of actuators are brakes, clutches, solenoids, relays, valves and pumps.

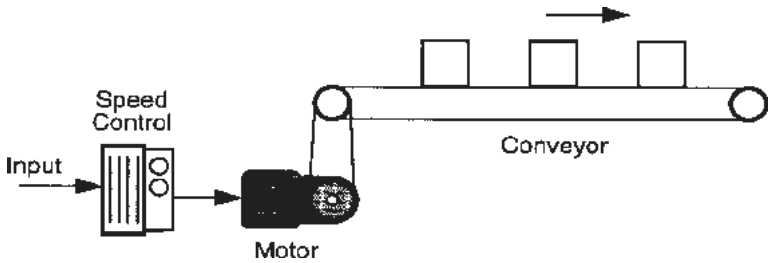

Fig. 8-1: Typical open-loop control system.

Actuator Controls: Actuator controls (such as motor controls) function as system controllers in very simple systems. In more complex control systems where the motor is one of many actuators, the motor control is usually under the command of a separate system controller.

Sensors: A variety of sensors are used in process control systems to determine the status of each process. They are used to measure velocity, position, weight, volume, tension, temperature, pressure, etc. They are transducers that convert a physical property to an electrical signal which can be interpreted by the controller. The sensor output causes the controller to trigger some form of actuator to begin, end or interrupt a process.

Signal Interfaces: Sensors, actuators and controllers all operate on a variety of signal levels and types. Therefore, interfaces must be employed to translate signals or boost signal levels from one device to another. For example, the output of a digital computer must be converted to an analog signal before it can be used by a brushless DC motor control. Conversely, the output of an analog transducer must be converted to a digital signal before a digital computer can act on it. The voltage or current levels of sensor outputs are often too low to be interpreted by a controller, and therefore need to pass through an amplifier stage before being processed.

Control System Types

Control system operation is usually divided into two basic types:

- 1) open-loop (no feedback), and
- 2) closed-loop (with feedback).

The type of system used depends on the type of application and the degree of control needed to control the process.

Open-Loop Operation: Open-loop control systems do not utilize feedback. In other words, the input to the system is set at a level to achieve the desired output and the state of the output has no effect on the input. See Fig. 8-1.

A simple motor-driven conveyor transporting boxes from one work area to another, at a set speed, is an example of an open-loop system. The speed is set by the conveyor operator and will vary only slightly depending on the load. If a person at the end of the conveyor fails to remove the boxes in a timely manner, the boxes will drop off the end of the conveyor. The motor speed will not adjust for variations in the output unless someone physically reduces the speed or turns the power off. The boxes dropping off the end of the conveyor (the output) have no effect on the motor speed (the input).

Closed-Loop Operation: A closed-loop system measures the output of the process and feeds a signal back to a junction point at the input of the system

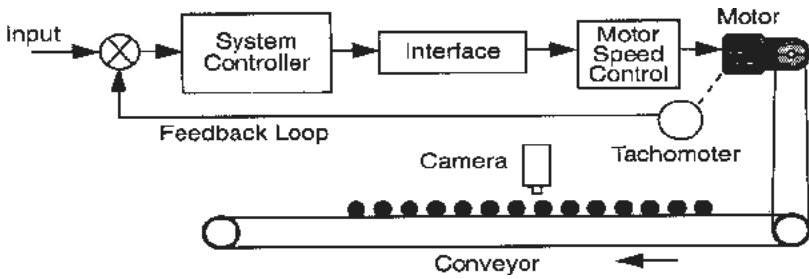

Fig. 8-2. Typical closed-loop control system.

where it is compared to the input signal. The input defines the desired output. Changes in load or component values can cause the output to differ from the input. This error signal causes the output of the system to change in a way that acts to reduce the error signal to zero.

A conveyor used in an automatic parts inspection process is an example of a closed-loop system. Since the parts must pass through a camera's field of view at a steady rate, the velocity of the conveyor must be held constant. Refer to Fig. 8-2. A tachometer, located at the drive output, feeds back a continuous signal to the system input that is proportional to the velocity of the output shaft. This feedback signal is compared to a reference input signal. Any variation in the output signal results in an error signal which causes the motor control to alter the speed of the motor until the error signal is reduced to zero.

The accuracy of such a system will depend on the calibration and stability of the input reference and the accuracy of the transducer converting the output quantity (velocity) to a voltage for feedback purposes. The input reference, feedback transducer calibration and stability are not included in the feedback loop, and as a result, are not subject to the loop's self-regulation.

Servo Control Systems: Servo systems are closed-loop systems that follow a velocity, torque or position com-

mand. Servo systems can be divided into three basic types based on the type of input signals used to control the output.

- 1) *Type 0* results in a constant position output when a constant input is applied.
- 2) *Type 1* results in a constant velocity output when a constant input is applied.
- 3) *Type 2* results in a constant acceleration output when a constant input is applied.

Various types of system controllers can be used to improve the response of a servo system by adjusting the error between the output signal and the input signal in different ways.

- 1) *Proportional (P)* controllers adjust the system gain.
- 2) *Proportional plus Integral (PI)* controllers adjust the gain and also increase the type number of the system by one, allowing other inputs to be accepted.
- 3) *Proportional plus Derivative (PD)* controllers allow the gain and the transient response of the system to be changed.
- 4) The *Proportional plus Integral plus Derivative (PID)* controller allows the gain, system type and transient response to be changed in order to improve operation.

For detailed information on servo control theory, the reader should consult the many reference sources available on the subject.

Motors used in servo drive systems must have certain performance characteristics:

- 1) linear speed / torque characteristics,
- 2) smooth torque delivery,
- 3) rugged construction,
- 4) high torque-to-inertia ratio,
- 5) high torque-to-power input, and
- 6) low electrical time constant.

The performance requirements of the system will determine which of these features are necessary. However, linear speed / torque characteristics are generally considered critical requirements for servo applications.

8.2 MOTOR OPERATING CHARACTERISTICS

Motor controls can be designed to regulate speed, torque, velocity and position. In some cases, acceleration and deceleration time constants can also be regulated. When motor velocity vs. torque is plotted on $\pm x$ and $\pm y$ axes, it reveals the characteristic speed / torque curve. In this discussion, velocity and speed are often

used interchangeably. If you refer to Chapter 1, you'll recall that speed is mathematically represented as the absolute value of velocity and therefore has no directional component.

Figure 8-3 shows the four quadrants of motor operation. Torque (T) is plotted on the "x" axis while angular velocity (ω) is plotted on the "y" axis. The direction of rotation (clockwise or counterclockwise) determines if a positive or negative torque or velocity is generated. Operating a motor within these four quadrants will produce various speed / torque relationships that will facilitate varying degrees of motion control. The designer needs to evaluate the degree of control that is required by the application early in the motor and control selection process to determine which motor is best suited for the application.

Different motors and controls exploit various aspects of the four quadrants better than others. A motor which can operate in all four quadrants offers more control over speed and torque and direction of rotation. The down side is that a motor control system, capable of four-quadrant operation, is usually costlier.

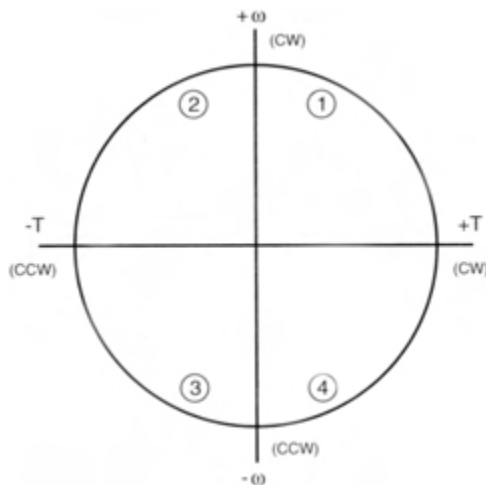

Fig. 8-3: Four quadrants of motor operation.

When selecting a motor control method, it is often advisable to discuss the control aspects with the motor or control manufacturer. Sometimes, solutions can be provided early in the design phase which will save considerable amounts of design time and money. For instance, servo motors are designed for high performance applications, which makes them more costly. However, not all four-quadrant applications require servo motor performance. Therefore, a system designer can often save money if the requirements of the application can be met by a less costly motor control system.

Single Quadrant Operation

A typical speed / torque curve for a permanent magnet (PM) motor or brushless DC motor is shown in Fig. 8-4a. The direction of shaft rotation is clockwise. By convention, when a motor shaft turns in a clockwise direction, it delivers some degree of positive torque at a given positive velocity. These characteristics are plotted in the first quadrant of the graph. A motor operating in the first quadrant is doing

work. It is generating a force to displace a mass at a certain speed.

Two Quadrant Operation

Figure 8-4b shows the characteristics for the same brushless DC motor running in a counterclockwise direction. The velocity and torque are negative since the direction of rotation is reversed. All motors are capable of first quadrant operation. Reversible motors can operate in the first and third quadrants. This simply means that they can provide positive torque at a positive velocity and negative torque at a negative velocity.

Controlling Motors with Linear Speed / Torque Characteristics

Motor design engineers have learned that controlling motor speed is easier when the motor exhibits linear speed / torque characteristics. A close look at the relationship between velocity and torque and how certain motor designs can exploit their

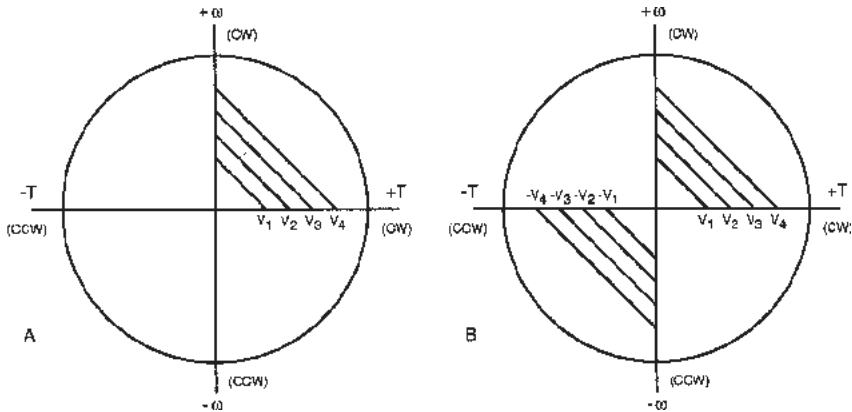

Fig. 8-4: Typical PM or brushless DC motor speed / torque curves: a) forward direction, positive velocity, positive torque (left), and b) reverse direction, negative velocity, negative torque (right).

linear characteristics will help the reader to understand why these motors provide more versatile control capability.

In Chapter 1, Section 1.2, we learned that force (F) on a current-carrying conductor immersed in a magnetic field is a product of the magnetic flux density (B), the conductor's current (I) and the length of the conductor (l):

$$F = BIl \quad [1]$$

A somewhat similar effect occurs when a conductor of length (l) is moved with velocity (v) through a magnetic field (B). A voltage (V) appears between the ends of the conductor according to the relationship:

$$E = \int_0^l (v \times B) dl \quad [2]$$

This formula reduces to $E = Blv$. In a motor, the effect of current on the force generated and the effect of velocity on voltage occur together. Motion is produced by applied current and a generated voltage is produced by the resulting motion. The generated voltage (E) always acts to oppose and limit the normal applied current flow. It is referred to as counter emf or back emf.

In rotating machines, the conductors take the form of coiled turns. The torque developed on each turn of such a coil is often alternately expressed as the product of the current and the rate of change of the flux linking the turn. Therefore:

$$T = i \frac{d\lambda}{d\theta} \quad [3]$$

where λ is magnetic flux linking the winding and θ corresponds to the angular displacement.

Similarly, the voltage generated in each turn of the coil may be expressed as the rate of change of flux linkage with respect to time.

$$E = \frac{d\lambda}{dt} \quad [4]$$

Since λ is a function of rotary position θ

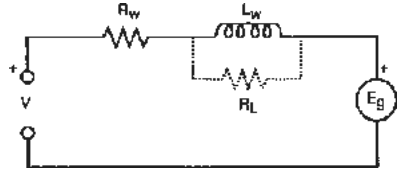

Fig. 8-5: Equivalent circuit for a single winding of a PM type or a brushless type DC motor.

the equation may be written:

$$E = \frac{d\lambda}{d\theta} \times \frac{d\theta}{dt} \quad [4]$$

where $\frac{d\lambda}{d\theta}$ = angular velocity.

Figure 8-5 shows the equivalent electric circuit for one phase of a PM brush-type DC motor. The same circuit also applies to a brushless DC motor. It is represented by a voltage source (V) connected to a series combination of R_w (winding resistance), L_w (winding inductance), with shunt resistance (R_L) and a voltage source (E_g) representing the counter emf. The resistance (R_L) is usually of a high enough value that its effect on motor operation is insignificant and can therefore be omitted from the circuit model.

Since the normal commutation function connects each phase or combination of phases in sequence to the voltage source (V), the circuit model for the overall motor is represented by the same basic circuit, except for the fact that the circuit values may represent more than one winding "on" at a time. The circuit model shows that the voltage generator (E_g) acts in opposition to the normally applied source voltage (V). Consequently, the current flowing in the phase will result from $(V - E_g)$ acting across the impedance made up of R_w and L_w .

The equation for the motor equivalent circuit is written:

$$V = L_w \frac{di}{dt} + R_w i + E_g \quad [5]$$

For the steady state analysis and since the inductance of the typical motor is usually small enough that it can be ignored, the

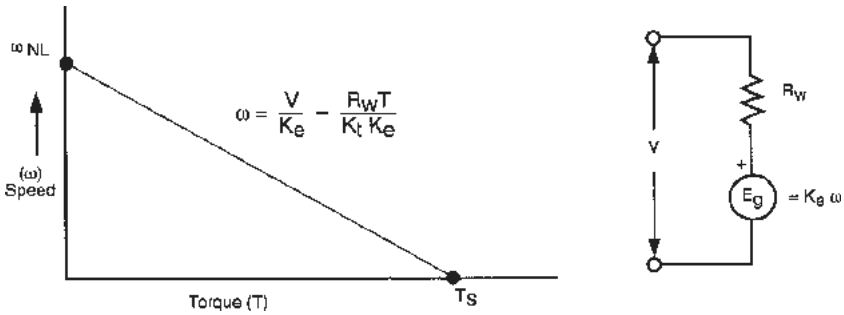

Fig. 8-6: Speed / torque curve of either a PM brush-type or a brushless DC motor using a simplified model.

above equation can be reduced to:

$$V = R_w I + E_g \quad [6]$$

or $V = R_w I + K_e \omega \quad [7]$

where K_e is a function of turns and magnetic flux. K_e is called the voltage constant. It is a proportionality constant that relates the generated voltage to shaft speed (ω).

If the motor current (I) is constant, a proportional torque is produced:

$$T = K_t I \quad [8]$$

where K_t is a function of turns and magnetic flux. K_t is called the torque constant and is a proportionality constant that relates current to developed torque.

Solving the torque equation for current and substituting the resulting expression for I in the voltage equation yields:

$$V = \frac{TR_w}{K_t} + K_e \omega \quad [9]$$

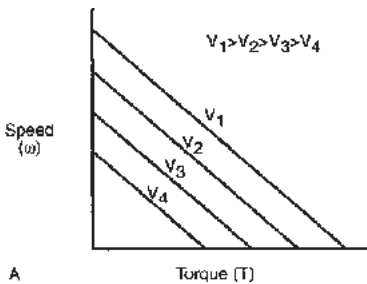

Fig. 8-7: Typical speed / torque characteristic of either a PM brush-type or a brushless DC motor.

Solving for ω results in a linear equation relating velocity (ω) to the developed torque (T):

$$\omega = \frac{V}{K_e} - \frac{R_w T}{K_t K_e} \quad [10]$$

where

$$-\frac{R_w}{K_t K_e} \text{ is the slope}$$

and

$$\frac{V}{K_e} \text{ is the axis intercept.}$$

The intercept corresponds to the operating point at which $T=0$ (no load).

Therefore:

$$\omega_{NL} = \frac{V}{K_e} \quad [11]$$

Torque at stall may be solved in similar fashion by setting $\omega=0$.

$$T_s = \frac{VK_t}{R_w} \quad [12]$$

Figure 8-6 shows a plot of the speed/ torque relationship. Both no-load and stall torque are influenced equally by changes in applied voltage (V). Increasing V shifts the speed / torque characteristic outward away from the axis in a parallel fashion. A given motor will therefore display parallel speed / torque characteristics corresponding to the different applied voltages as shown in Fig. 8-7.

Stall torque may be influenced independently by adjusting the equivalent circuit series resistance (R_w). An increase in

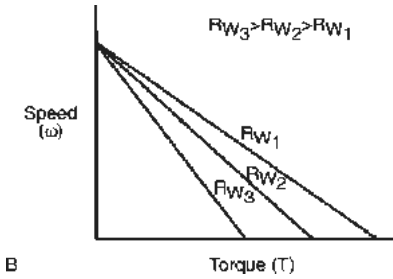

Fig. 8-8: Effect on speed / torque curve of varying R_w .

resistance has the effect of increasing the slope of the speed vs. torque characteristic while no-load speed remains unaffected. Figure 8-8 illustrates the effect of changing R_w . The motor design variables that affect K_t and K_e tend to have interrelated effects on the speed / torque characteristics. In developing the model for the speed/torque characteristic we assumed that the winding inductance (L_w) was negligible.

A further examination of the speed/ torque equation reveals that velocity (ω) decreases as the torque load (T) is increased with voltage (V) held constant. This is the expected result, and is typical of a permanent magnet DC motor. Similarly, velocity (ω) will increase with increasingly applied voltage if the torque is held constant. This relationship is significant in the control of motor speed. An increase in torque load will decrease the motor speed, but the speed can be corrected by a small increase in the applied voltage.

Speed control of PM brush-type and brushless DC motors is accomplished by adjusting the voltage applied to the motor. Figure 8-9 illustrates how a constant speed is maintained by varying the voltage. If the load is held constant, the speed (ω_c) can be maintained by applying a constant voltage (V_c). But if the load increases, as illustrated by the dashed line (L_2) and the voltage remains constant, the speed will decrease to ω_2 . In order to maintain the constant speed (ω_c), the voltage must be

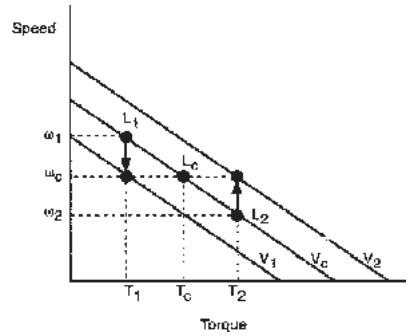

Fig. 8-9: Controlling DC motor speed by varying applied voltage.

increased to V_2 . Likewise, if the load decreases (L_1), the speed will increase unless the voltage is reduced to V_1 . With a smooth stepless range of voltage adjustment, the motor may be operated at any point (T, ω) within the rated maximum torque and rotor speed.

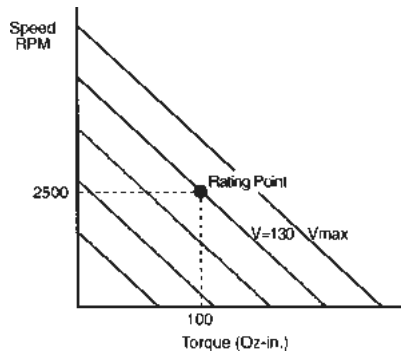

Fig. 8-10: Typical speed / torque characteristics for a 1/4 hp DC motor.

Rating Point: Figure 8-10 shows a speed / torque characteristic curve for a typical 1/4 hp DC motor. The rating point, in this example, corresponds to a voltage of 130 VDC, a torque of 100 oz-in. and a speed of 2500 RPM. We learned earlier that we can maintain a constant speed by increasing or decreasing the voltage proportionally to changes in load. In this example the voltage limit is set at V_{max} . This is the maximum voltage that can be applied to

the motor for safe operation. It also establishes a limit on the amount of torque which can be delivered at higher speeds, which we will illustrate next.

Regulated Speed: Many motor applications require a regulated speed over a varying load range. A conveyor application where a constant speed must be maintained regardless of the number of items on the conveyor is an example.

Theoretically, a DC motor could maintain a constant speed for any load if it had an unlimited current and voltage source. In reality however, every motor and control has a current and voltage limit. In many electronic controls, the current limit is adjustable, allowing for variable torque in addition to variable speed.

If the 1/4 hp motor in Fig. 8-10 was attached to a control device, a series of regulated speed characteristic curves could be developed like those shown in Fig. 8-11. The current curve has also been added to show the effects of current limiting on regulated speed.

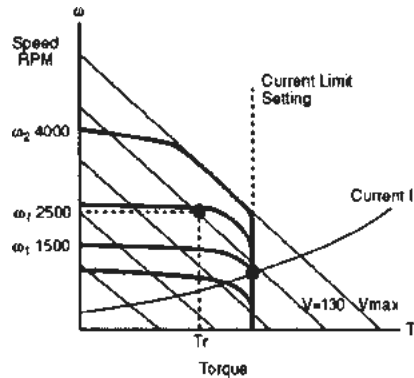

Fig. 8-11: Regulated speed curves for a typical 1/4 hp DC motor and speed control.

The dashed vertical line represents the current limit point for this motor and control. Some controls provide a trim potenti-

ometer which allows this point to be adjusted. Adjusting the current limit increases or decreases the available torque.

The regulated speed curves show that for a rated speed (ω) of 2500 RPM, this system is capable of delivering above-rated torque at a constant speed up to a point near the current limit value. Just prior to the current limit value, the speed will start to drop off sharply until it reaches current limit at which time the motor will stall. The degree of drop off or slope of the regulated speed curve is determined by the design of the motor and control.

If the motor is operated at a speed lower than the rated 2500 RPM (ω), it will again deliver a maximum torque up to the current limit point. At lower speeds however, it will not require as much voltage. At higher than rated speeds (ω), the motor speed will be affected by the voltage limit. It will deliver a constant speed until the voltage limit is reached. The speed will then decrease at a rate determined by the slope of the V_{max} curve until it reaches current limit, at which time the motor stalls. The regulated speed / torque curves indicate how much the speed will vary over a given torque range.

Four Quadrant Operation

Some applications require a greater degree of motor control. For instance, the motor may be required to reverse while running, thus generating a negative torque while running at a positive velocity, or vice versa. To accomplish this, a motor and its control must be able to operate in the second or fourth quadrants where load torque is in the direction of rotation. Motors with linear speed / torque characteristic provide the best four quadrant operation. Servo application which follow a velocity, torque or position command require four quadrant operation to achieve optimum system

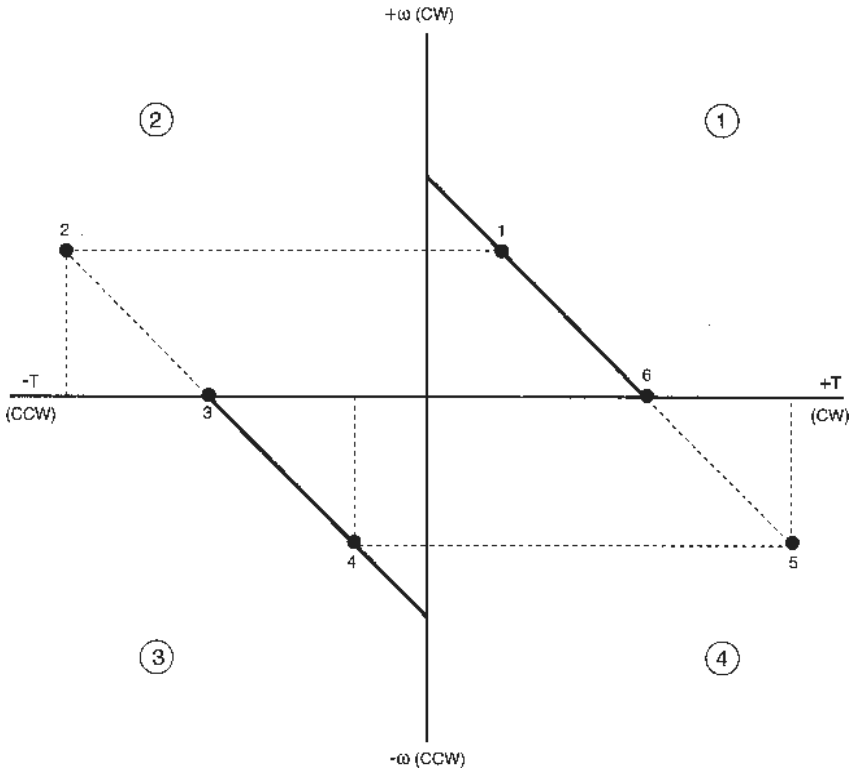

Fig. 8-12: A typical DC motor in four quadrant operation.

response. That is why a linear speed / torque relationship is a strict servo motor requirement.

Reversing Motor Direction:

Now that we have examined the control theory of motors with linear speed / torque characteristics, we can demonstrate their control capabilities by showing a typical four quadrant application.

Figure 8-12 shows a linear speed / torque characteristic curve typical of a PM brush-type as well as a brushless DC motor. Since it is applying a positive torque at a positive velocity, the characteristics are plotted in the first quadrant. Point 1 on the characteristic curve represents the operating point for a given load value. Assume for this example that the motor runs constantly and is being controlled by a

system controller. At certain points in the process the motor must reverse direction when it receives the command from the controller. For simplicity of discussion, all losses due to windings, hysteresis and other physical properties are considered negligible in this example.

At the instant the motor receives the reverse command, the current direction will switch to a negative value and the motor will begin to operate in the second quadrant. In other words it will instantly begin to generate a negative torque while maintaining a positive velocity represented by point 2 on the graph.

At point 2, the current is reversed and the applied voltage is reversed. The motor is still putting out a positive velocity so the back emf, which is a function of velocity and which normally limits the current, now

becomes an additive component for the time it takes the velocity to decay to zero (point 3). This can be seen if we analyze the equivalent circuit formula:

$$V = R_w I + E_g$$

Under first quadrant conditions, V and $R_w I$ are both positive while the E_g component is negative. Therefore, E_g opposes the applied voltage. When the reverse command was given, the polarity of the applied voltage and current were both switched. The negative current immediately begins generating a negative torque. However, the rotor and shaft are still turning with a positive velocity. During the period of time from point 2 to point 3 as the positive velocity is decaying, the E_g component of the equation is still negative. Therefore, instead of opposing the applied voltage and limiting the current, E_g instantaneously aids in developing additional torque. Although this time is quite short, the motor control (if any) and the load must be able to tolerate the instantaneous increase in torque at point 2.

Once the velocity decays to zero at point 3, the motor stalls. Because E_g is a function of velocity which is now zero, there is no back emf until the current generates a force in the opposite direction. When the negative current exerts a force in the opposite direction, the resulting counterclockwise movement causes a back emf to develop and the motor velocity increases in the negative direction to a value limited by the load. This is represented by point 4.

Since quadrants three and four are mirror images of quadrants one and two, when the reverse command is given again a similar series of events occur in quadrants four and one (represented by points 5 and 6 on the graph) until the motor again returns to full load speed.

Regenerative Drives: When a

motor performs work, it dissipates power in the form of heat and other losses. There are times when the motor must maintain a constant velocity or torque while being aided by other physical forces. For example, when a conveyor on an incline moves a box in an upward direction, it is performing work and normal losses occur. But when the same conveyor is reversed and the box is lowered, the motor is aided by the force of gravity and the mass of the box. The inertia of the load tends to overhaul the motor and puts power back into the power supply.

Most motor control systems do not offer regenerative capability. A control system must be specifically designed to absorb or store the additional power for a time until it can be dissipated. The example given earlier where a switch is thrown to reverse a DC motor is another example of where power must be absorbed momentarily by the control power supply. During the few seconds between the time the current is reversed and the motor stalls, power is being put back into the system because there is no back emf to limit the current.

8.3 MOTOR CONTROL TYPES

Motor controls can be divided into two basic categories:

- 1) passive device speed controls, and
- 2) solid state controls.

Passive device controls consist of fixed or variable resistors, or variable transformers that are used to adjust the magnetic field strength, voltage levels or other motor characteristics (depending on the motor type), in order to control motor speed.

Solid state controls utilize more complex circuits consisting of active devices like diodes, thyristors, transistors, integrated circuits and in some cases, microprocessors to control motor voltage, power

supply frequency, or to provide electronic commutation and thereby control motor speed.

Electronically commutated motors use logic circuits which develop rotating magnetic fields by rapidly switching coil currents on and off. The on/off timing of the logic circuits is usually controlled by built-in sensors or specialized motor construction features which monitor rotor position.

Brushless DC, switched reluctance and stepper motors use electronic commutation. They cannot be operated by simply connecting them to a power source; the control is required for proper operation.

Electronically commutated motors with the appropriate controls can generally control position, direction of rotation and torque in addition to speed. Usually, they operate in closed-loop mode except for stepper motors which operate in open-loop mode because of their unique construction. These electronically commutated motors were discussed in Chapters 3 and 4. We will examine the control aspects of these motors later in this section.

8.4 PASSIVE DEVICE MOTOR CONTROLS

The most economical motor speed controls use passive devices such as variable resistors and transformers to control motor electromagnetic characteristics. These controls are described below for both DC and AC motors.

Controlling DC Motor Speed

The speed and torque of a DC motor can be described by the following equations:

$$RPM = k \frac{V_a - I_a R_a}{\phi} \quad [13]$$

$$T = K\phi I_a \quad [14]$$

where:

RPM = revolutions/minute

V_a = armature voltage

I_a = armature current

R_a = armature resistance

ϕ = field flux

T = motor load or torque

k, K = constants

Equation [13] indicates that speed can be varied by changing any of the variables, V_a, R_a or ϕ . Consequently, there are three methods by which the speed of a DC motor can be controlled:

- 1) *Field Weakening* —The field flux (ϕ) in some motors can be altered by means of a series rheostat.
- 2) *Armature Resistance Control* — Voltage across the armature can be changed by introducing variable resistance in series with the armature resistance (R_a). Improved speed regulation can be obtained by incorporating two variable resistances, one in series and one in parallel with the armature.
- 3) *Armature Voltage Control* —Voltage across the armature (V_a) can be varied through the use of a controlled voltage source to a motor with separately excited field and armature circuits.

Shunt-Wound DC Motor Passive Speed Controls

Let's apply the three basic methods of speed control to the various types of DC motors beginning with the shunt-wound type.

Field Weakening Control: In order to weaken the field of a shunt-wound DC motor, a rheostat can be connected in

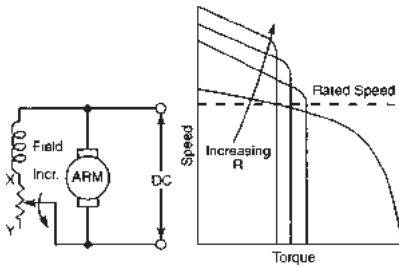

Fig. 8-13: Simple series field resistance circuit and shunt-wound DC motor speed / torque characteristic.

series with the field winding while the armature voltage is kept at the “rated” or line voltage ($V_1 = V_a$). As shown in Fig. 8-13, the introduction of a field rheostat will permit adjustment of field current from point X (no additional resistance and full field current) to point Y (maximum resistance and minimum field current). An increase in field resistance will decrease the available field current and consequently, the field flux (ϕ).

The effect of reducing the field flux while maintaining the armature voltage is an increase in motor speed. Therefore, field control or “field weakening” will normally produce speeds above the base (rated) speed. It should be noted, however, that the field can only be weakened within limits. Weakening the shunt-wound DC motor field beyond a certain point can result in excessively high and unstable speeds. It can also result in overheating the armature as can be seen from equation [2] in that a reduction of field flux (ϕ) will produce a corresponding increase in armature current (I_a) in order to maintain a given load (T).

Furthermore, with an excessively weak field and a high armature current, the shunt-wound DC motor will be increasingly susceptible to armature reaction, excessive brush arcing and loss of breakdown torque. To prevent this, the maximum permissible limit for this speed control method is generally 150% of the motor’s rated basic speed. Furthermore, the maximum load of the motor must be reduced when

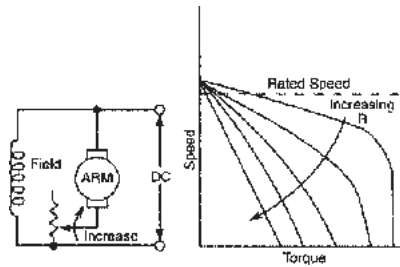

Fig. 8-14: Simple series armature resistance circuit and shunt-wound DC motor speed / torque characteristic.

operating above the basic speed so that its horsepower rating is not exceeded.

Armature Resistance Control:

Essentially opposite to the field weakening method, armature resistance control calls for a variable resistance connected in series with the armature, while the field winding is excited at rated or line voltage. See Fig. 8-14. By reference to equation [13], if the voltage across the armature (V_a) is reduced (by increasing resistance), motor speed will decrease. Therefore, armature resistance control will always reduce speed below the rated base speed of the motor.

As indicated in equation [14], an increase in load will result in an increase in armature current which, in turn, causes an increase in voltage across the series connected resistor. For this reason, if the motor is started with no load at some setting below the base speed and a load is subsequently applied, there will be a sharp drop in motor speed and a corresponding I^2R power loss across the resistor. Therefore, the series resistor must have enough capacity to match the load current.

Using a resistor in series with either the armature or field is also very inefficient and is not considered practical for most applications. This method however, is relatively inexpensive and will effectively control DC motor speed both above and below the base speed in some applications.

Shunted Armature Connection: In a variation of the armature resistance method, both series and shunt resistors may be used “in tandem” to improve speed regulation characteristics of a DC shunt-wound motor by making the operating speed somewhat less susceptible to changes in load torque. This factor may become especially important in cases where the precise nature of the load torque is not well known, yet it is desirable to pre-set the operating speed.

In the shunted armature connection method, a variable resistor connected in parallel (shunt) with the armature acts to increase the current through the series resistance and thus reduce the difference between the no-load and the full-load current. The series resistance may be used to control armature voltage in the same way as with armature resistance control. See Fig. 8-15. Shunt resistors also assist dynamic braking and are, therefore, used in cases where a shunt motor is applied to a load which must be braked.

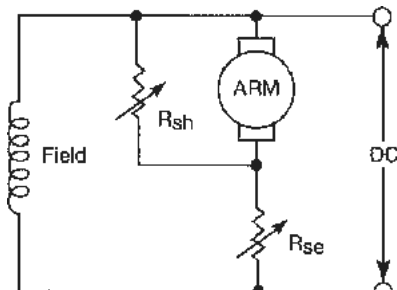

Fig. 8-15: Shunted armature speed control method.

Armature Voltage Control:

There are two types of armature voltage control:

- 1) nonfeedback type, and
- 2) feedback type.

The nonfeedback control consists of a field power supply and a manually adjustable armature power supply. As motor

load changes, speed regulation is equivalent to the inherent regulation of the motor as shown in the speed / torque curves in Fig. 8-16.

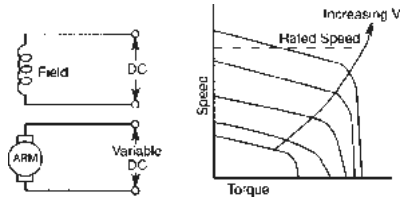

Fig. 8-16: Example of variable armature voltage supply.

The feedback type is a silicon controlled rectifier control and will be discussed with solid state controls in Section 8.5.

Permanent Magnet (PM) Motor Passive Speed Controls

The motor equations [13] and [14] at the beginning of this section can be applied to a permanent magnet (PM) motor. Notice, however, that a PM motor has a fixed field strength, and therefore, the field flux (ϕ) cannot be varied. Hence, there are only two methods to control the speed of a PM motor.

Armature Resistance Control:

This is the same method described for shunt-wound motors. A variable resistance placed in series with the armature can be varied to increase or decrease the voltage across the armature and cause the motor speed to change. See Fig. 8-17.

Armature Voltage Control:

By increasing or decreasing the voltage supply to the armature of a PM motor, the motor speed can be adjusted. Voltage adjustment can be achieved through the use of a variable voltage transformer.

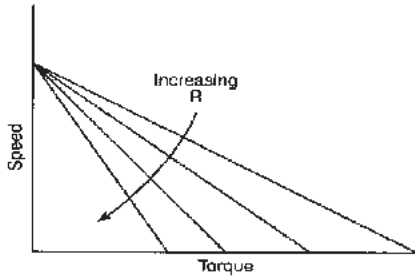
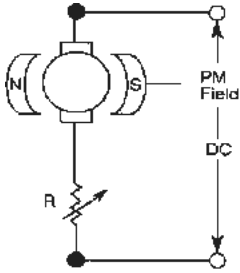

Fig. 8-17: Armature resistance control circuit for a PM DC motor and associated speed / torque characteristics.

Series Wound (Universal) Motor Passive Speed Controls

A series wound motor is suitable for AC or DC operation and is capable of supplying high starting torques, high speeds and high outputs. The speed of a series motor can be changed by varying the voltage across the motor. This can be achieved by either using a variable resistor, a variable voltage transformer (autotransformer) or an electronic control.

Series Resistance Control: A variable resistor or rheostat in series with the motor will decrease the speed of the motor at any load as the resistance is increased. In theory, the motor speed can be adjusted to a standstill. However, due to starting torque limitations, armature cogging and reduced ventilation, the minimum speed is usually limited to some higher value.

A series resistor introduces a voltage drop in the circuit directly proportional to the current flowing. The voltage across the resistor, therefore, will increase as the motor is loaded (since the motor current will increase with load). It follows that the voltage across the motor will decrease with an increase in load and the speed will drop more rapidly with load whenever a series

resistor is used. The higher the resistance value, the greater the drop in speed as the load is increased. Also, a series resistor will have its greatest effect on the starting torque of the motor since at starting, the maximum current is flowing and will limit the motor voltage to its lowest value. The minimum full-load speed at which a series motor will operate on AC with a series resistor is usually limited by the starting torque available to start the load with that value of resistance.

Typically on AC, the speed range of a series motor using a variable series resistor will be from 1.5:1 to 3:1, depending upon the motor. On DC, the speed range will be increased because of the improved regulation and corresponding increase in starting torque. Typical characteristic curves for a series motor are shown in Figs. 8-18a and b.

Shunt Resistance Control: A series motor can also be controlled by shunting an adjustable resistor across the armature. The speed range is usually limited by this method because of the increased current passing through the field coils and the corresponding heating effect. A wide speed range may only be employed if the application has a very intermittent duty cycle.

Using the same motor as above, typical characteristic curves are shown in Figs. 8-18c and d. Although the speed range is limited, this method of control improves the

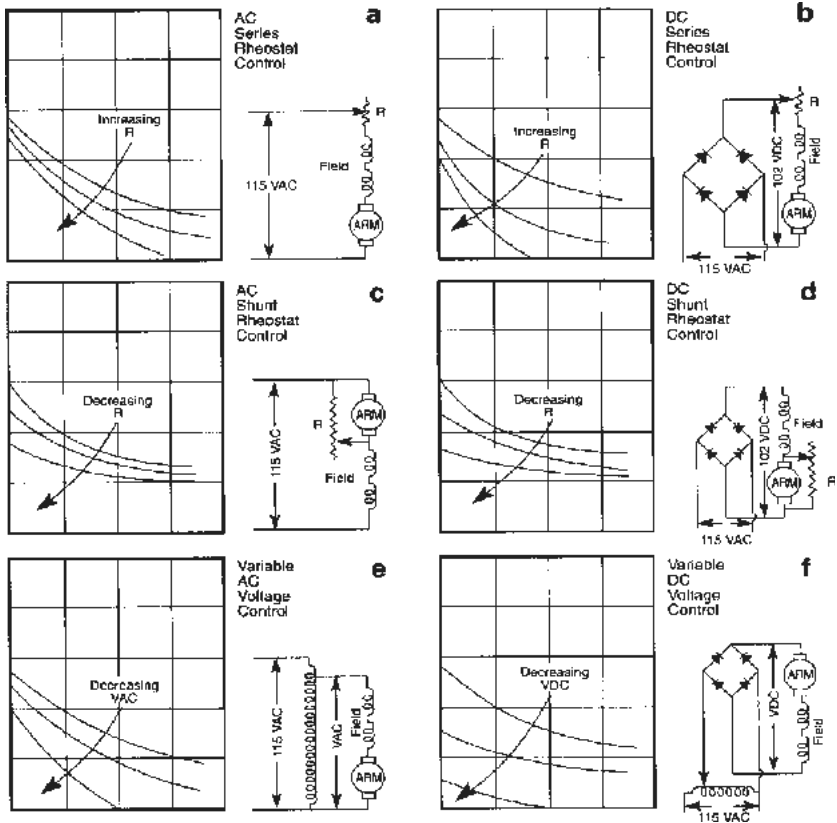

Fig. 8-18: Series wound motor passive device speed control methods: a) AC series rheostat control, b) DC series rheostat control, c) AC shunt rheostat control, d) DC shunt rheostat control, e) variable AC voltage control, and f) variable DC voltage control.

speed regulation of the motor and maintains good starting torque characteristics. It is an excellent method for matching motor speeds.

A combination of series and shunt resistors is sometimes used to obtain characteristics between the two types of controls.

Variable Transformer Control: By using a variable transformer to vary the voltage across a series motor, speed ranges of 4:1 to 7:1 are typical depending upon the motor. If a full-wave bridge is used to convert the output of the transformer to DC, the speed range will be increased because of improved regulation

and starting torque. Figures 8-18e and f show typical characteristic curves for the motor used in Figs. 8-18a, b, c and d.

AC Motor Passive Speed Controls

One of the principal characteristics of the AC induction motor is its ability to maintain constant or essentially constant speed under normal voltage and load variations. Therefore, this type of motor does not lend itself to a simple method of speed control over a wide range.

Some types of loads, however, make practical some degree of speed adjustment if the proper motor and control means are chosen. First, it should be understood that there are variations of conventional induction motors which are designed for the express purpose of improved speed control. These motor types may employ wound rotors with variable resistance, brush shifting means and other special features. This discussion, however, will be confined to induction motors having the conventional squirrel cage nonsynchronous, reluctance synchronous and hysteresis synchronous rotors.

The speed of an AC motor is related to the power supply frequency (Hz) by the equation:

$$RPM = \frac{120f}{P} \quad [15]$$

where:

- RPM = revolutions/minute
(nominal synchronous speed)
- f = frequency (Hz)
- P = number of poles

The above speed represents the synchronous speed of the revolving magnetic field of the stator in a nonsynchronous motor or the actual rotor speed of a synchronous motor.

While a synchronous AC motor rotates at the exact speed defined by the above formula, the nonsynchronous motor never operates at synchronous speed. The difference between the synchronous speed and the actual speed is known as rotor "slip":

$$Slip = \frac{Sync. Speed - Actual Speed}{Sync. Speed} \quad [15]$$

The magnitude of slip depends upon the rotor design, power input and motor load. As in the case of the DC motor, the speed of an induction motor can be made to vary by changing any of the variables in the fundamental speed equation, such as:

- 1) adjusting supply frequency,
- 2) changing the number of stator poles,
- 3) adjusting power input, and
- 4) controlling rotor slip.

The change in frequency method requires the use of solid state driven power supplies and falls in the category of solid state controls, which will be discussed in Section 8.5.

Change in the Number of Stator Poles

The pole-changing method (Fig. 8-19) is also suitable for both synchronous and nonsynchronous motors, but has the limitation of offering only a few speeds (usually no more than four), which are widely separated from each other. By nature, the pole-changing method requires that a portion of the winding be idle during the operation of one or more speeds. This results in motor inefficiency and a considerable reduction in the output rating for any given frame size. Switching methods for pole-changing are also expensive and complicated, making

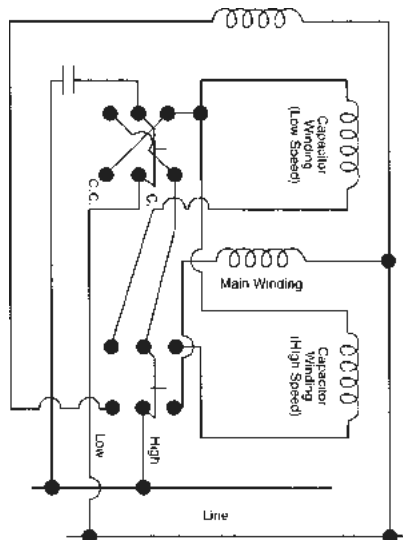

Fig. 8-19: Simplified pole-changing circuit.

the method useful in relatively few applications.

Changing Rotor Slip

The changing of rotor slip is simpler, less costly and the most widely used technique for varying the speed of an AC induction motor.

There are three types of nonsynchronous motors to which this method is best suited: shaded pole, permanent split capacitor and polyphase. The latter is not widely used in fractional horsepower motor sizes.

NOTE: Due to the sensitivity of the centrifugal or relay starting switches, the rotor slip method should not be applied to split-phase start and capacitor start motors unless the speed will never go low enough to engage the starting switch. If the motor is running at reduced speed with the starting switch closed, the auxiliary winding or switch contacts would soon burn out.

To obtain the optimum speed control effectiveness in applications employing the change in rotor slip method, the following guidelines should be followed:

- 1) *Since the principle is based on changing the power input, it is important to match the motor closely with the load.* This will ensure that with a change of power input, a noticeable change in speed will result.
- 2) *The load should have a substantial component of inertia.* If the load is not of the fan or blower type, it may be necessary to add a fly-wheel to provide this necessary inertia. **NOTE: A non-inertial load cannot be satisfactorily controlled by the change in rotor slip method.**
- 3) *It is advisable to use a rotor specifically designed and constructed for high slip (high degree of slope of the speed/torque curve).* This will aid in

obtaining the maximum speed change for a given change in motor power input.

There are several ways to change the power input to an induction motor, and thereby increase or decrease the amount of slip. Listed below are those which are most frequently used.

Series Resistance Method:

A variable resistor can be used to vary voltage across the winding of an induction motor. See Figs. 8-20a and b. Series resistance can be used with either shaded pole or PSC motors.

Variable Voltage Transformer Method: This method may be used in place of a series resistor to reduce voltage across the winding. It has the advantage of maintaining substantially the same voltage under the starting condition when the current is higher than during the running

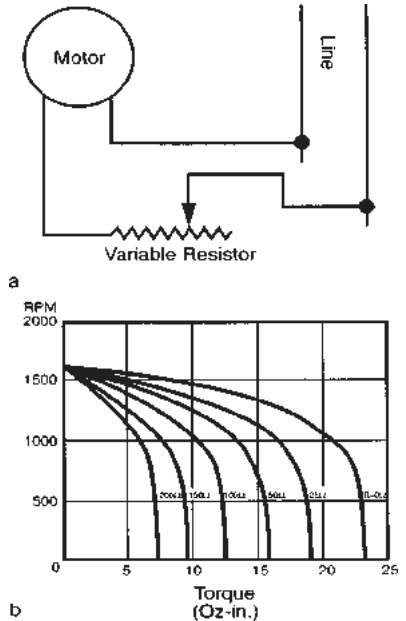

Fig. 8-20: a) Simplified series resistance circuit (top), and b) change of motor speed by series resistance method (bottom).

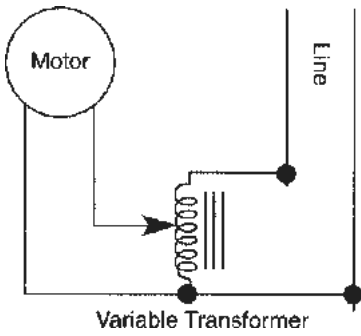
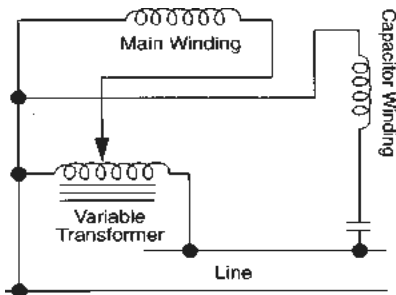

Fig. 8-21: Variable voltage transformer method.

mode. There is also much less power lost as heat than with a resistor. See Fig. 8-21.

By reducing the voltage across the main winding of a PSC motor, full voltage is maintained across the capacitor winding, providing more stable operation at lower



a

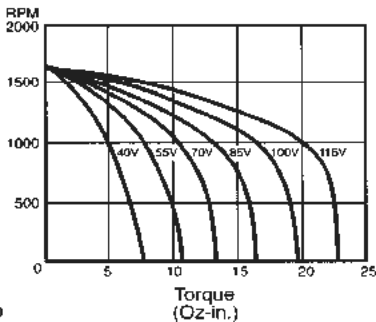

b

Fig. 8-22: a) Variable voltage transformer method in a PSC motor (top), and b) varying PSC motor speed by the variable transformer method (bottom).

speeds. See Figs. 8-22a and b.

Shunt Resistance Method:

Also confined to the PSC motor, this method has been found to provide stable speed in four-pole, 60 Hz motors up to 1/100 hp (7.5W) over a range from 1500 RPM down to 900 RPM with a constant torque output. See Figs. 8-23a and b. With this method, it is necessary to use a high slip type rotor.

Tapped Winding Method:

This method is most widely used in shaded pole fan motors. The change in input is obtained by changing motor impedance through the use of various portions of the total winding. See Fig. 8-24. The number of speeds is determined by the number of taps introduced into the winding. In addition,

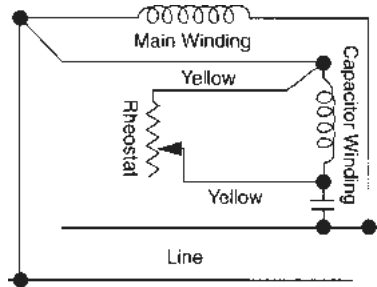

a

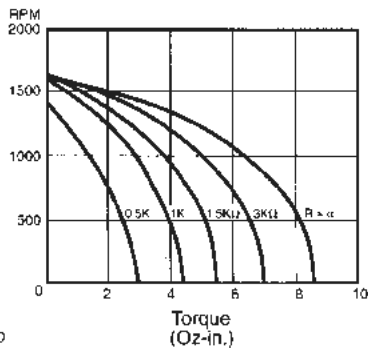

b

Fig. 8-23: a) Shunt resistance method (top), and b) change of PSC motor speed by shunt resistance method (bottom).

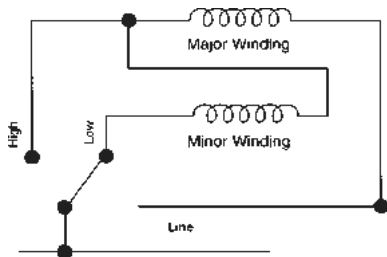

Fig. 8-24: Tapped winding circuit.

Winding Function Change

Method: Applicable only to the PSC motor, the winding change method can be used in applications requiring no more than two speeds. See Fig. 8-25. The functions of the main and the capacitor (starting) windings can be switched to provide “high” and “low” speeds. High speed is obtained when the winding with fewer turns is functioning as the main, while lower speed is achieved with the winding with more turns functioning as the main. This is an extremely efficient technique, but it does require that the motor winding be exactly tailored to the load in order to provide the desired two speeds.

8.5 SOLID STATE ELECTRONIC (ACTIVE) MOTOR CONTROLS

Advances in solid state electronics such as VLSI technology as well as improved manufacturing techniques like surface mount component technology have led to many improvements in motor controls. The continuing drive for miniaturization has led to smaller controls which offer better performance and greater reliability than their predecessors. Many of these changes have also driven down the cost of controls.

Control system designers are discovering that an electronic control, when matched with the right motor, can offer a method.

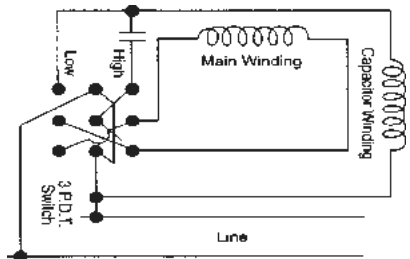

Fig. 8-25: Winding function change

package that is smaller and just as economical over the life of the application as some of the earlier, less sophisticated controls.

This section will cover solid state control of both DC and AC motors. We will begin with the simpler speed controls such as SCR and PWM and end with electronic commutation controls.

Active vs. Passive Control of DC Motor Speed

In Section 8.4, you’ll recall that the speed of a DC motor can be varied by changing any of the variables in the basic speed formula:

$$RPM = k \frac{V_a - I_a R_a}{\phi}$$

Passive devices such as resistors increase the motor circuit resistance, causing increased power dissipation in the form of heat. This additional heat produces no useful work and decreases the overall efficiency of the system. With the development of semiconductors, it became possible to vary motor speed through voltage switching rather than by adding resistance to the drive circuit.

Instead of varying the level of resistance, switching amplifiers vary the time during which full line voltage is applied to the armature. The net effect is an average voltage which is roughly equivalent to a

voltage level obtained by the variable resistance-type control.

To see how these two techniques work, think of two simple circuits, each with a light bulb, a power source and a current control device. In Fig. 8-26a, a variable resistance controller is used. In Fig. 8-26b, a switch is connected in series with the light bulb and power source. In the variable resistance system, the resistor can be regulated to control the current and produce a light intensity from 0 to maximum rated.

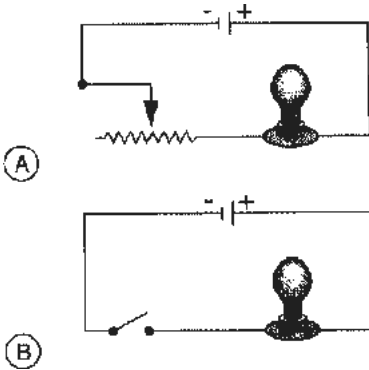

Fig. 8-26: a) Simplified variable resistance control circuit (top), and b) switching circuit technique (bottom).

In the switching system there are only two possible states: “on” or “off.” To vary the light intensity, the switch may be turned on and off many times per second. Each combination of on/off states represents one cycle. Since semiconductor switching can take place at very high frequencies, the eye perceives an average intensity somewhere between off and maximum. The longer the bulb is left in the “on” state during each cycle, the brighter the light will seem to glow.

In a similar fashion, semiconductors vary motor speed by switching voltage to the motor windings on and off very rapidly. The longer the voltage is “on”, the higher the average voltage will be and concurrently, the higher the resultant motor speed.

Pure DC vs. Rectified AC

The quality of the direct current and voltage used to drive a motor has a significant effect on its efficiency. Before we discuss the various solid state controls used to control DC motor speed, it is important to review some basic DC theory and to see how DC motors are affected by various grades of DC.

AC Rectification: Rectification is essentially the conversion of alternating current (AC) to unidirectional current (DC). It is the most economical means of generating DC, since it utilizes commercially available AC sources. However, the degree to which the alternating current is converted will determine the overall efficiency of the motor and control system.

A simple diode can be used for half-wave rectification. Full-wave rectification can be obtained by using two diodes in a center-tapped transformer circuit. A four-diode bridge circuit will also provide full-wave output. These circuits are shown in Fig. 8-27.

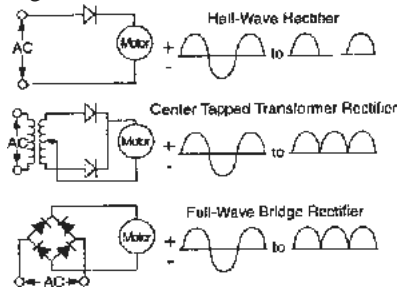

Fig. 8-27: Typical half-wave (top) and fullwave (middle and bottom) rectification circuits employing diodes.

Later we will see how SCRs are used to create full and half-wave rectification in DC motor controls. We can see from the wave shapes (current diagrams) that rectification provides unidirectional current, but

not uniform or pure DC. It is the measure of departure from pure direct current that can have a significant effect on motor efficiency.

Form Factor: Form factor is a measure of departure from pure DC. It is defined as the root-mean-square (rms) value of the current divided by the average value of the current. Pure DC has a form factor of 1.0 or unity. For half-wave rectified current, the form factor is 1.57. For full-wave rectified current, the form factor is 1.11 when measured with a resistive load.

The form factor is an important consideration with motors designed to operate on direct current. When operated from rectified power vs. pure DC, the increase in motor heating for a constant output is approximately proportional to the square of the form factor. For example, a motor operating from half-wave rectified DC current will have approximately 2½ times the heat rise of the same motor operating on unity form factor DC.

To accommodate the increased heating effect of high form factor current, continuous duty applications generally require a larger (and more costly) motor to drive a given load. Stated another way, a designer may save money by using a low cost, high form factor speed control, only to sacrifice much of the savings by using a larger motor to keep the motor operating temperatures within design limits.

High form factor also means that a high peak current is required to maintain an average current output for a given power requirement, thus contributing to rapid brush and commutator wear.

Filtering: Filtering methods act to “smooth out” the rectified current or voltage waveform by means of series inductance and/or parallel capacitance. The effects of filtering can be seen in the waveforms in Fig. 8-28.

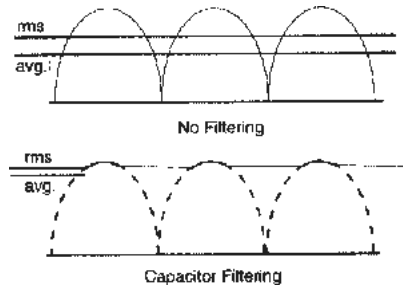

Fig. 8-28: Filtered vs. unfiltered full-wave rectification.

The filter capacitors in Bodine controls improve the armature current form factor to near unity (1.00), and also result in higher average voltage available for a relatively wider range of speed control. The advantages of full-wave rectification with filtering can be seen in the chart in Fig. 8-29.

Typical Feedback Controller Speed		
Type	Form Factor	Range
Half-Wave Unfiltered	1.6 - 2.0	65%
Half-Wave Filtered	1.1 - 1.5	120%
Full-Wave Unfiltered	1.1 - 1.6	80%
Full-Wave Filtered	1.0 - 1.1	130%

Fig. 8-29: Effects of various types of rectification and filtering on form factor.

SCR Phase Control of DC Shunt and PM Motor Speeds

While the speed of a shunt-wound motor can be changed by varying either the field or armature voltage, a PM motor’s speed can be varied only by changing the supply voltage to its armature. Some controls utilize the field weakening method

for shunt-wound motor speed control. This is not the preferred method however, since changing the field voltage directly affects the output torque capability of the motor and should only be used where relatively light loads are encountered. Changing the motor armature voltage, on the other hand, allows full torque to be developed.

Most motor controllers for the fractional horsepower DC shunt-wound and PM motors use silicon controlled rectifiers (SCRs) as the control element for varying the power applied to the motor. The SCRs control the armature voltage and thus, the motor's speed.

An SCR is a three-terminal device made from four layers of alternating P and N-type semiconductor materials. See Fig. 8-30. It functions as a diode (only conducts current in the forward direction), but will do so only when a trigger voltage is applied to its gate.

Once an SCR is fired, the gate signal can be removed without stopping conduction. Conduction ceases when the positive voltage is removed from the anode. The typical gate signal required to activate an SCR is about two volts and 10 milliamps for three microseconds. Although these values are representative trigger requirements, an SCR gate can tolerate much higher power inputs without damage.

The rectifying capabilities of SCRs

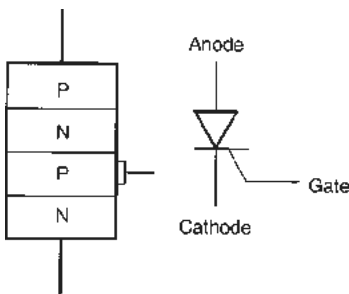

Fig. 8-30: Function diagram and standard schematic symbol for a silicon controlled rectifier (SCR).

make them popular in speed controls. They can be directly connected to the AC source to form a half-wave rectifier without AC-to-DC conversion circuitry. When an SCR is used to rectify alternating current, the point during the positive half cycle of the input current at which the rectifier is turned on can be adjusted by the timing of the application of the trigger signal to the gate. At the end of the positive half cycle, the SCR will turn off as the applied polarity of the voltage reverses. By controlling the phase relationship of the trigger to the zero axis crossing of the positive half cycle of alternating current, the amount of power transmitted through the SCR can be varied. This is called phase control. One or more SCRs can be used to provide phase-controlled half-wave, full-wave or multiple-phase control.

The combination of a counter emf sensing element, a triggering unit whose phase is controlled by the counter emf sensor, and one or more SCRs constitutes a basic feedback speed controller.

Half-Wave SCR Controls: In a half-wave SCR motor control, the gate signaling characteristics of the SCR are used for speed selection and as feedback for compensation of load changes.

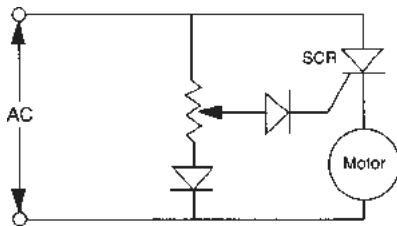

Fig. 8-31: Feedback control circuit using the counter emf of the motor as the feedback control voltage.

The circuit illustrated in Fig. 8-31 uses the counter emf of the motor as a feedback control voltage (motor speed is proportional to counter emf). Gate firing occurs

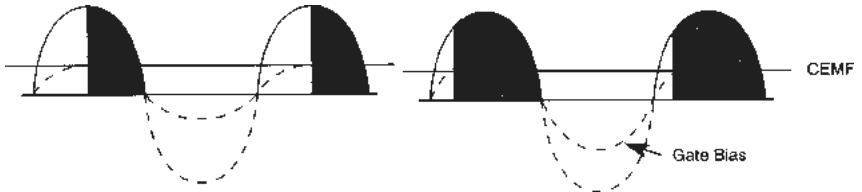

Fig. 8-32: Voltage waveforms of a half-wave SCR control. If motor speed decreases, the SCR will automatically fire sooner in the cycle. The shaded areas are proportional to the power delivery.

when the divided fraction of the supply voltage (developed at the center arm of the potentiometer) exceeds the counter emf developed by the motor. At this moment and for the remaining portion of the half cycle, the input voltage is applied to the motor. If the motor should slow down due to an increase in load, the counter emf will be lower and the SCR will automatically fire sooner in the cycle (thus allowing the SCR to be on for a larger portion of the half cycle). The voltage waveforms associated with this control operation are shown in Fig. 8-32. With this circuit, the SCR can be controlled only through the 0 to 90 degree range.

Half-wave rectified SCR controls, while inexpensive, do not operate a motor at its full potential. For example, a motor operating from a half-wave rectified DC current will have approximately $2\frac{1}{2}$ times the temperature rise of the same motor operating on pure DC. Since motor life is inversely related to temperature, the motor will have a much shorter life. This temperature rise is directly related to the form factor discussed earlier.

Full-Wave SCR Controls:

Full-wave SCR controls optimize a motor's performance. They can be constructed using two SCRs with a center-tapped transformer or as a full-wave bridge where two of the diodes are replaced by SCRs. See Figs. 8-33a and b.

By using full-wave rectification in conjunction with filtering to smooth the rectified current or voltage waveform, the form

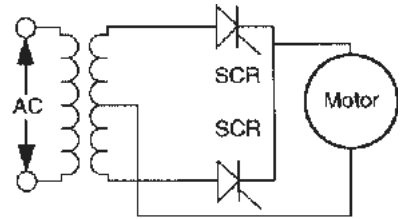

(A)

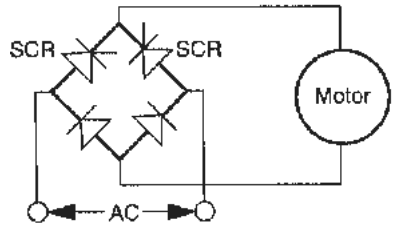

(B)

Fig. 8-33: a) Full-wave SCR control using a center-tapped transformer (top), and b) using a bridge configuration (bottom).

factor is improved significantly. Refer to Fig. 8-29 for the effects of filtering on form factor.

Like the half-wave control, the timing of the control signal of the full-wave SCR determines the "firing angle" (the electrical angle from the zero crossing point when the SCR fires). See Fig. 8-34. When the SCR is switched on, current flows to the motor winding. The position of the firing angle determines the average voltage and in turn,

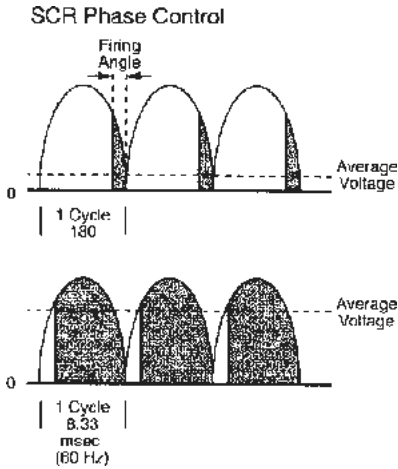

Fig. 8-34: The effect of the firing angle on the average voltage of a full-wave SCR control.

the output speed. If the SCR fires early in the cycle, current flows to the windings for a longer time and the average voltage is higher.

IR Compensation: Speed can be maintained at a nearly constant level regardless of changes in motor load with the addition of IR compensation. While the voltage developed by a tachometer is sometimes used as an output speed signal, in most controllers it is the counter emf generated by the motor that is compared with a reference voltage to regulate speed.

To compensate for varying loads, the applied armature voltage and armature current (proportional to load) are sensed. The difference ($V-IR$) is proportional to motor speed. This voltage is compared to the reference voltage established by the external speed setting potentiometer. The difference or error is used to automatically increase or decrease the armature voltage and thus, the motor shaft speed. If the controller senses a counter emf that is lower than the reference voltage, it will increase power to the motor. This will increase the speed and the generated counter emf. This

action will continue until the difference between the counter emf and the reference voltage equals zero. If the counter emf exceeds the reference voltage, the controller will decrease the power to the motor.

Figure 8-35 illustrates an SCR speed control consisting of a counter emf sensing element, an emf phase-controlled triggering unit and an SCR. Inherent motor characteristics combined with a reflected load make it impractical to achieve regulation closer than about 1% using counter emf and armature current as the feedback signals. However, a tachometer generator can be incorporated as the feedback element to achieve speed regulation approaching 0.1%. In Chapter 9 we will discuss feedback devices such as tachometer generators and encoders in greater detail.

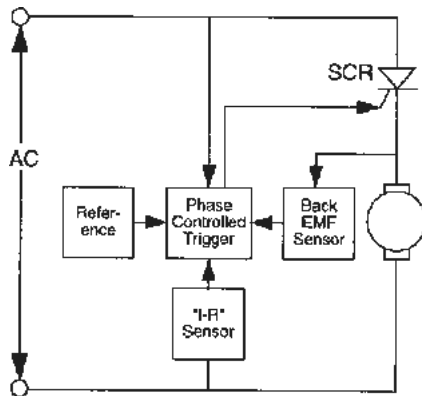

Fig. 8-35: Interrelationship of elements in a basic SCR feedback speed control.

Other Compensation Techniques

In addition to providing feedback circuitry which adjusts output power to maintain constant speed as load varies, the following features can also be included in a well-designed SCR control.

Line Voltage Compensation:

AC line voltage typically varies by as much as $\pm 10\%$. Since motor speed is proportional to voltage, motor speed will fluctuate as the line voltage varies. Hence, it is important to incorporate line voltage compensation circuitry features in the motor control to maintain speed settings.

Temperature Compensation: A motor's armature winding resistance (R_a) is not always constant during its operation. It rises and falls with the ambient and operating temperature and can cause control instability. Selection of circuitry components with low temperature coefficients can help reduce speed changes caused by temperature variations. However, some temperature compensation devices must also be built into the control circuit to sense the winding temperature and make up for the resistance variations due to temperature change.

Torque Limiting (Current Limiting): In some drive applications, a limit must be placed on maximum torque output. For example, a winding machine may require that wire tension be limited to a maximum to avoid breakage.

Since motor torque can be expressed by the equation $T = kIa$, torque is directly proportional to armature current. Therefore, limiting the current to the armature also limits the torque. A controller with a torque limiting circuit can draw current up to a preset value, after which the motor's speed will "drop off." The nature of the drop-off is dependent on control design, initial speed, inertia, rate of torque increase, etc.

In addition to maintaining a limiting torque, torque control is also useful for soft starting (controlled acceleration) of loads that are essentially inertial in nature.

Surge Suppression: An abnormal voltage "spike" can damage the sensitive components of a controller. A transient

protector or surge suppressor should be used to divert the voltage surges. Thyrectors and varistors are two devices commonly used for this purpose. Figure 8-36 shows a varistor used in a bridge circuit to protect a controller's circuitry.

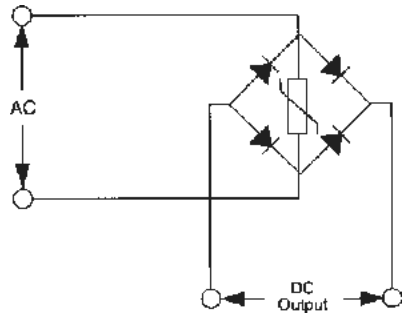

Fig. 8-36: Surge suppression using a varistor.

RFI Suppression: Any instantaneous change in voltage across an energy storage network will result in the emission of RFI (radio frequency interference). The RFI that is created is simultaneously propagated through the air and conducted through the elements of the system. In the case of electronic motor controls, rapidly changing voltage across a capacitor through the use of an SCR or arcing at the motor brushes may result in RFI which may cause disturbances in nearby electrical apparatus.

RFI can be prevented from reaching places through the use of filters for the conducted portion and shielding for the portion propagated through the air.

The shielding of electrical equipment to prevent the propagation of RFI through air is difficult. This is because the strength of the RFI signal at any given distance from the source depends not only on the orientation of the RFI source with respect to the receiver, but also on the amount of amplification of RFI due to the antenna action of objects to which it is physically connected. For this reason, shielding

should be individually designed for each application.

Prevention of conducted RFI from reaching and introducing noise to the supply line can be accomplished with a filter placed between the line and the control as shown in Fig. 8-37.

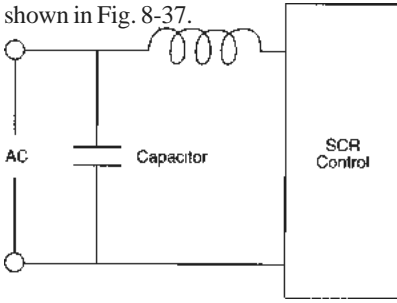

Fig. 8-37: Simple RFI filter.

A simple filter design consists of an inductance choke put in series with the input and a bypass capacitor put across the line. The impedance of the choke increases with increased frequency. Its impedance is negligible at 60 Hz but presents a high impedance at the frequency of the RFI range, which causes some portion of the conducted RFI to drop across it. The impedance of the capacitor decreases with increased frequency. It is virtually an open circuit at 60 Hz but almost a short circuit at the RFI frequency, and so some portion of the RFI is shunted across it.

Pulse Width Modulation Control of DC Motor Speed

Pulse width modulation (PWM) circuits use transistor switches instead of SCRs as voltage control devices. The circuits are similar in their basic function. In a pulse width modulation control, a DC-to-pulse-width converter converts a control signal voltage to an appropriate pulse width or

“firing angle” resulting in the correct average voltage for a given desired speed setting.

When the transistor is switched on, current flows in the winding. Just like the SCR control, the firing angle in a PWM circuit (the electrical angle between the start of the cycle and the angle at which the transistor begins to conduct) determines the average voltage and in turn the output speed. A wider pulse width will result in a higher average voltage. See Fig. 8-38.

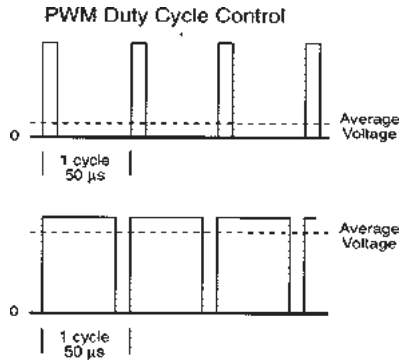

Fig. 8-38: Effect of pulse width on average voltage in a PWM circuit.

Figure 8-39 shows that a power amplifier is used to amplify the control voltage to provide the actual drive current, while a feedback circuit tracks the armature voltage level.

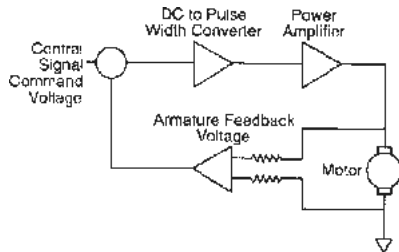

Fig. 8-39: Typical PWM control circuit.

PWM controls operate from pure DC and require an external power supply with a high degree of rectification and filtering. As a result they can be costlier than SCR controls.

However, unlike SCRs which can turn current on but not off, transistors are not dependent on the negative cycle of the AC source for turning off the winding current. Because the PWM drive operates from a pure DC source, the relationship between pulse width and motor voltage is linear (Fig. 8-40) and has little lag. This gives PWM controls the quick response necessary for many servo applications.

The pulse repetition rate (cycle duration) ranges from 1–100 kHz, depending on the characteristics of the motor and application. The transistor's ability to generate a wide range of pulse widths gives PWM controllers a very wide speed range and precise control of peak motor current.

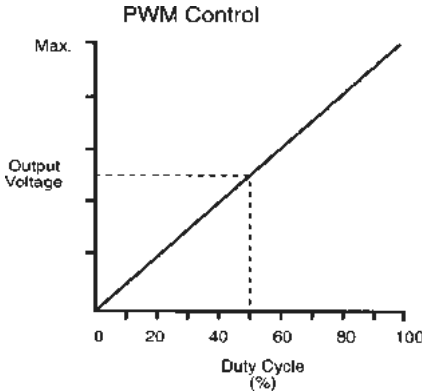

Fig. 8-40: Linear characteristics of a PWM control.

Electronic Commutation of DC Motors

Some motors are controlled through electronic commutation. Brushless DC and DC stepper motors are examples of electronically commutated motors. Both of these motors were described in Chapter 3. Electronically commutated motors cannot be operated by connecting them to a power supply. The control is required for

commutation (motor action) as well as for speed, position and torque control. In this section, we will examine the types of controls used with brushless DC motors and stepper motors and the effects they produce on the motors.

Brushless DC Motor Controls

Brushless DC motor controls perform a variety of functions. One primary function of the control is commutation. Commutation takes place by sequentially switching the current in one or more stator phase windings to generate a revolving magnetic field. The magnets in the rotor cause motor action by chasing the revolving magnetic field generated in the stator windings.

The on/off switching of phase current is a function of rotor position. Rotor position is determined by sensors located in the motor itself. The rotor position information is fed to the commutation logic circuits in the control which determines the correct firing sequence of the transistors that supply current to the windings. Since the current is switched just before the magnets in the rotor align with the magnetic field generated in the stator, and since the current switching is governed by the rotor position, the rotor never catches up with the field. Brushless DC motors run at higher speeds than PM DC motors because their speed is not limited by the frictional components of mechanical commutation, but by the voltage limit of the control circuit and motor windings.

Trapezoidal vs. Sinusoidal Characteristics: Brushless DC motors can exhibit either trapezoidal or sinusoidal torque characteristics. It is the arrangement and type of windings as well as the physical characteristics of the stator and rotor that determine whether a motor

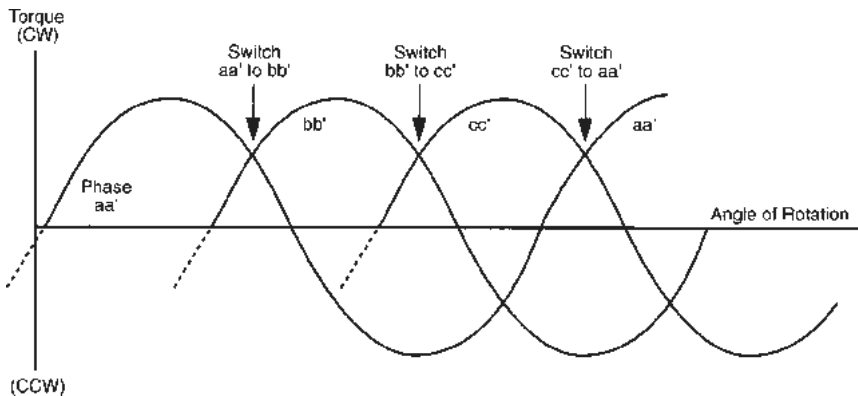

Fig. 8-41: Overlapping torque waveforms of a sinusoidal DC motor being driven as a generator.

will produce trapezoidal or sinusoidal waveforms.

The back emf of a DC motor always follows the waveform which a motor produces when it is externally driven. In other words, as a result of the motor's construction, the waveform which it produces when it is run like a generator determines the characteristics of the back emf. The commutation cycle and ultimately the torque output are dependent on the back emf. The shape of the waveform, therefore, is important. There is considerable difference of opinion among motor manufacturers as to which wave shape is better.

Figure 8-41 shows the overlapping torque waveforms of an externally driven, three-phase DC motor with sinusoidal

characteristics. From the curve we can see that torque is a function of rotor position. If you follow a single waveform you'll see that minimum torque occurs when the waveform crosses the axis. It then progresses to a maximum torque value before returning to a state of stable equilibrium. The back emf waveform follows this same path. Peak torque at constant current occurs when the back emf peaks. Therefore, in a brushless DC motor, by sensing the rotor position and timing the commutation circuits so that the phase coils are turned on near the top of the back emf waveform, we will generate a torque ripple output similar to the waveform shown in Fig. 8-42.

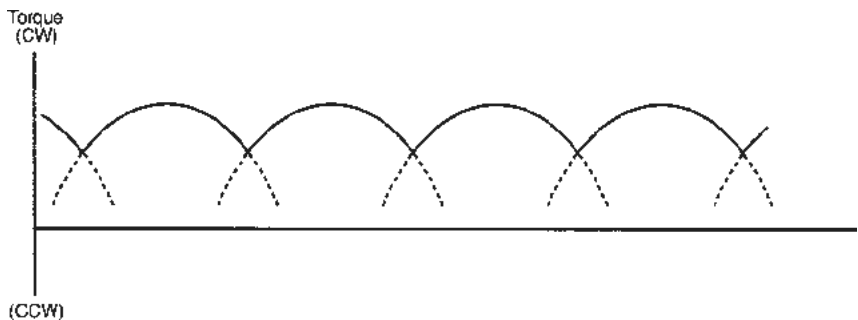

Fig. 8-42: Torque ripple of a sinusoidal brushless DC motor.

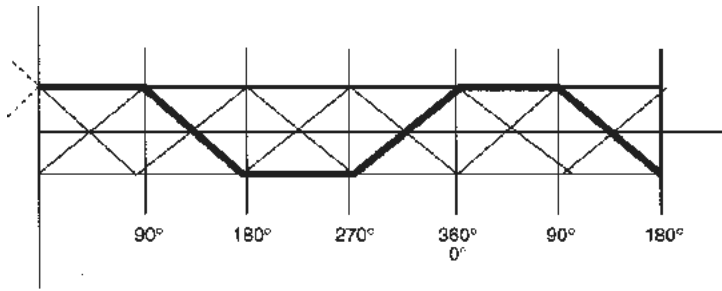

Fig. 8-43: Output waveforms of a DC motor with trapezoidal characteristics.

The torque output has a considerable amount of ripple. This could be reduced by increasing the number of motor phases and thus commutating on shorter cycles. This approach adds considerable cost to the control since more transistors and logic circuits are needed for commutation.

Another way to reduce the amount of ripple is to construct the motor to produce a trapezoidal characteristic waveform. Figure 8-43 shows overlapping torque waveforms of an externally-driven trapezoidal DC motor. Notice that the tops of the waveforms are flat by design. Therefore, if the commutation takes place at or near the top of the waveform, there is less ripple than with the sinusoidal design. This is represented by the bold line at the top of the waveforms in Fig. 8-43.

In general, motors with sinusoidal outputs are easier to construct and therefore, less costly. However, they generate considerably more torque ripple. High accuracy sinusoidal controls in combination with high resolution position sensors can produce very smooth torque outputs from a sinusoidal motor. However, the additional control circuitry and sensors add to the cost of the system.

Brushless DC motors with trapezoidal characteristics have flat torque curves and lend themselves to digital and pulse width modulation control techniques. The controls for trapezoidal characteristic motors are more cost-effective to produce than those for sinusoidal motors having the same

number of phases. Figure 8-44 shows the relationship between the various waveforms of a three-phase brushless DC motor with trapezoidal characteristics.

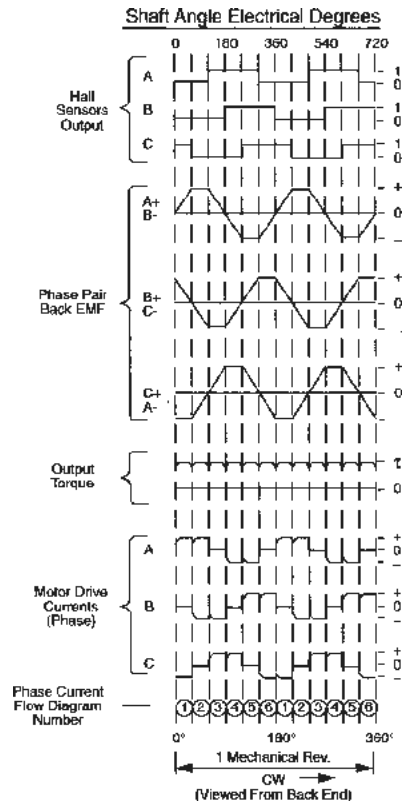

Fig. 8-44: Waveform relationships in a three-phase brushless DC motor with two phases energized and one off at all times.

Brushless DC motors can be used as servo motors depending on the application. They are capable of four quadrant operation and develop considerably more torque per frame size than their PM DC counterparts. Most brushless DC controls provide variable current limiting. Acceleration and deceleration response times are usually adjustable.

Stepper Motor Controls

Stepper motors can carry out extremely varied patterns of precise movements. Position is determined by the number of steps taken in either direction of rotation. Velocity is determined by the step rate. To produce the same sequence by other means might involve more expensive apparatus (resolvers, tachometer generators, etc.) and considerably more system maintenance. Perhaps the most distinct advantage of stepper motors is that they can perform a variety of complex operations with a noncumulative unloaded step error of 3% to 5% maximum of one step.

The basic function of any stepper control, no matter how simple or complex, is to provide the means of directing a stepper motor to complete a specific sequence of steps. Stepping is accomplished through the sequential energization of the motor's phases. The heart of any stepper system, the driver, is the device which actually conducts current from the power supply to the motor windings. This is accomplished via power transistors (represented by switches in Fig. 8-45). There are three principle types of stepper drivers:

- 1) Series R (also known as L/R),
- 2) chopper, and
- 3) bilevel.

Each can be configured in unipolar and bipolar modes which will be explained later in this section.

To prevent motor overheating, each

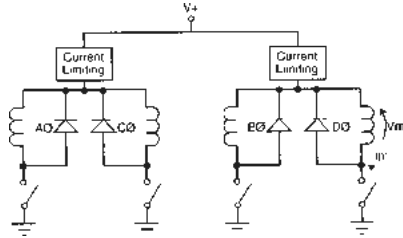

Fig. 8-45: Simplified representation of a stepper motor drive scheme.

power driver circuit uses a different method to limit current beyond the specified maximum for the motor. The differences in system performance are reflected in the time required for each driver type to bring the stepper motor up to full current, and the shape of their phase current vs. time curves.

Series R (L/R) Driver: The simplest, least expensive stepper driver is the Series R (or L/R) driver. In this scheme, resistors are connected in series with the motor windings. See Fig. 8-46. These resistors limit the maximum winding current to a safe operating level by adding to the divisor in the formula:

$$I_{max} = \frac{V}{R_{series} + R_{Winding}}$$

The electrical time constant for current rise is:

$$\frac{L_{Motor}}{R_{Series} + R_{Winding}}$$

To get adequate high speed performance, winding current must rise and decay quickly. This is accomplished by using high resistance series resistors to minimize the time constant, and correspondingly, high power supply voltages to attain adequate levels of current. Since a significant amount of energy is dissipated as heat in the resistors, Series R drivers are limited to applications which can tolerate additional heat and relatively low system efficiency. Advantages of Series R are low initial cost, system size and simplicity.

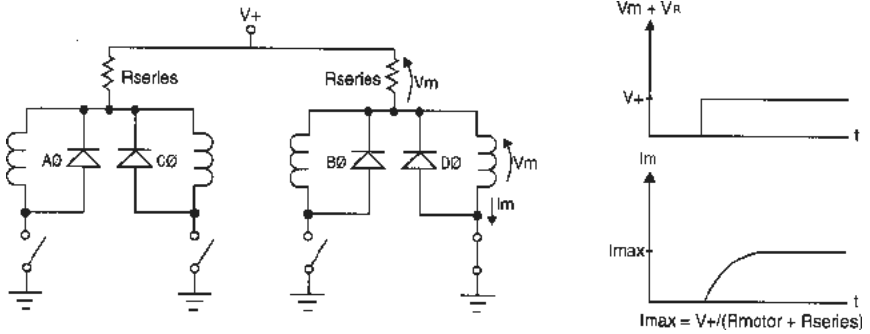

Fig. 8-46: Simplified representation of Series R drive scheme and associated waveforms.

Chopper Driver: With chopper drivers, external resistors are not used to limit the maximum flow of current. Limited only by the relatively small winding resistance, current would tend to rise to an unsafe level. To prevent this, the chopper driver will turn off the voltage across the windings when current reaches a preset maximum. See Fig. 8-47. The driver then monitors current decay, until it reaches a minimum level at which it reapplies the voltage to the windings.

Instead of a pure exponential curve, chopper drivers produce a sawtooth shaped current waveform like the one shown in Fig. 8-47. Since chopper drivers do not dissipate energy through series resistors, it is practical to increase voltage for much higher horsepower output. The on-and-off chopping action maintains current at safe operating levels. The high supply voltages used by these drives allow chopper drivers to reach maximum currents much faster than Series R drivers.

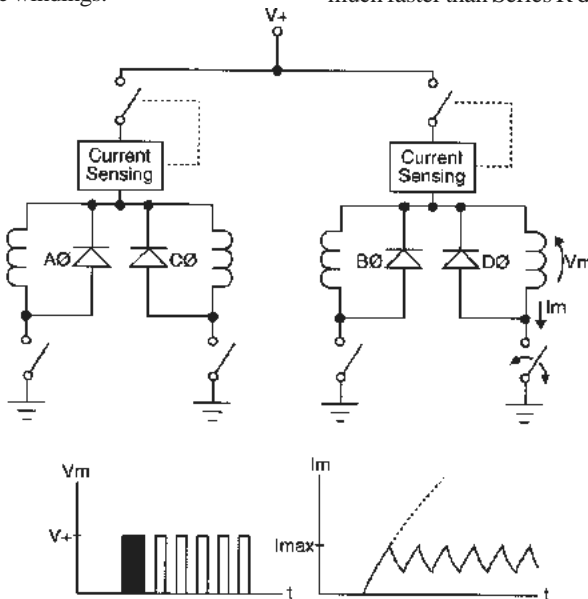

Fig. 8-47: Simplified representation of chopper drive scheme and associated waveforms.

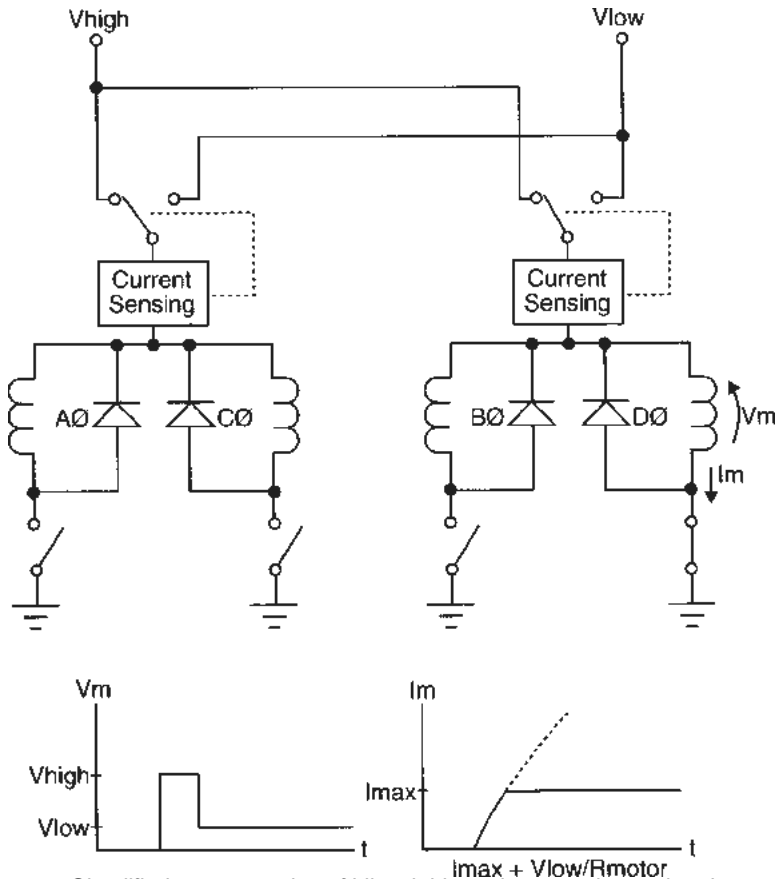

Fig. 8-48: Simplified representation of bilevel drive scheme and associated waveforms.

The one operational characteristic inherent in chopper circuits that may cause problems in some applications is the tendency for oscillating current to produce system resonances at certain frequencies or motor speeds. Vertical dips on the speed / torque curve represent narrow speed ranges in which the torque dips unexpectedly. These resonance effects can be diminished and sometimes eliminated by using electronic compensation circuitry.

Bilevel Driver: Rather than chopping current at a prescribed maximum, bilevel drivers switch between two separate input voltage levels. See Fig. 8-48. To bring the motor windings rapidly up to

maximum current, a relatively high voltage (typically above 24 V) is initially applied. Once the desired operating level has been reached, the driver quickly switches to a much lower maintenance voltage (typically under 10 V).

This dual voltage approach provides the rapid acceleration which is not possible with a Series R design, while minimizing some of the resonance effects found in uncompensated chopper drivers. The principle disadvantages encountered with bilevel drivers are the added expense for switches or transistors and the dual power supply needed to deliver the two voltages used by the scheme.

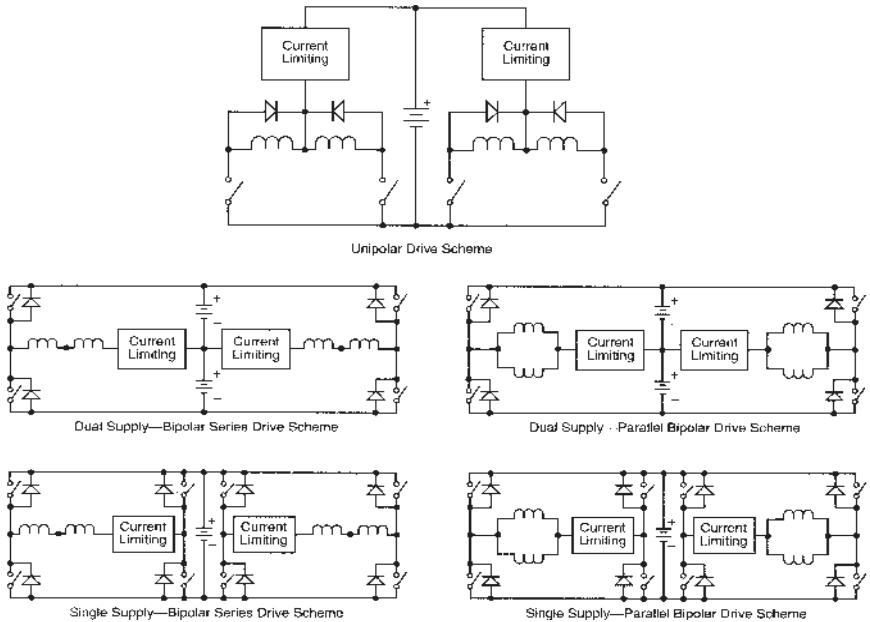

Fig. 8-49 Simplified representations of unipolar (top), bipolar series (left) and bipolar parallel (right) drive schemes.

Unipolar vs. Bipolar Modes

Each of three drive circuits used in step-motor applications can be configured into three basic modes:

- 1) unipolar,
- 2) bipolar series, and
- 3) bipolar parallel.

Each mode has advantages and disadvantages in terms of cost and performance. See Fig. 8-49. In the unipolar mode, two of the four windings are energized at any given instant, and current flows in only one direction through each winding. The sequence in which the windings are energized determines the direction of shaft rotation. In bipolar operation, all windings are on simultaneously. Rotation is produced by changing the direction of the phase current in the windings. No matter which method is used, the rotor “sees” the

same changes in direction of magnetic flux in the motor stator.

Unipolar Circuits: Unipolar drive circuits are generally simpler, more reliable and less expensive. They require only four drive transistors and a single power supply. Though they deliver somewhat lower torque for a given power input at low speeds, they usually produce higher torques at higher speeds.

Bipolar Circuits: With bipolar circuits, as many as eight power transistors or four power transistors and a dual power supply are needed. This adds cost and vulnerability to failure. But when high torque and very low speeds are application requirements and there are constraints on motor size, a bipolar driver may be the most desirable alternative. Since all four phases are energized at any given instant, the bipolar circuit generates a stronger magnetic field, delivering more torque to do the work.

Under static or low speed conditions, bipolar drivers can increase torque output by 20% to 40%. When connected in parallel, effective phase resistance and inductance are reduced by half. This allows current per phase to be increased to 140% of the “two-phase on” unipolar rating. When connected in series, the effective number of winding turns is increased, so the series bipolar circuit makes more efficient use of the windings. Voltage across the windings can be increased, while keeping current low (70% of the “two-phase on” unipolar rating). In some cases this permits less expensive power supplies and drive components to be used.

Stepper Motor Performance

Stepper motors operate in either of two speed ranges:

- 1) error-free-start-stop (EFSS), and
- 2) slew.

This combination of two operating ranges is unique to the “stepping” design. For each increment in the phase energization sequence, the stepper motor takes a precise known angular step. As mentioned earlier, the rotor follows the established

magnetic field through a series of detent positions one at a time, with a noncumulative unloaded step error of no more than 3% to 5%, provided the speed and acceleration capabilities of the motor are not exceeded.

If an application requires that the motor get from position “a” to position “b” as quickly as possible, a stepper motor must be carefully accelerated or “ramped” from its low to high speed range or it will lose synchronism with the magnetic field. Just as an internal combustion engine will stall if accelerated too quickly, “racing” a stepper will cause it to act unpredictably. In a typical application the motor may be commanded to “ramp” between low and high speed ranges many times, and each time the shape (slope) of the ramp will be an important factor in maintaining step accuracy.

Operating Speeds: The term EFSS (error-free-start-stop) is used to describe the stepper’s low speed operating region. In EFSS, the motor phases are switched relatively slowly, usually no faster than 1500 steps per second (even slower with larger motors). The maximum EFSS rate is dependent on load torque and load inertia. See Fig. 8-50. In the EFSS region,

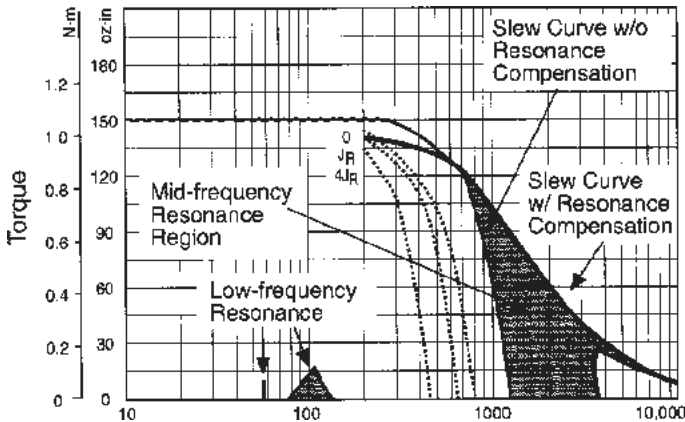

Fig. 8-50: EFSS and slew curves for a 34 frame single-stack stepper. Dashed lines are EFSS curves for zero, one and four times the stepper motor’s rotor inertia.

the motor can be started and stopped instantaneously without losing steps. If one or two phases are left on, the rotor will stop at the exact detent position corresponding to those phases.

Slew Speed: The high speed area of operation in a stepper is called the slew region. Here the windings can be sequenced quickly (up to 20,000 steps per second with the smallest stepper motors). If the sequence is suddenly stopped while the motor is operating in the slew region, inertia will cause the rotor to go beyond the desired holding position by at least four steps and possibly more.

In order to reach the slew region, the motor must first be started in EFSS and carefully accelerated to the desired slew speed. Then after rotating a particular number of steps at the higher step rate, the motor must be “ramped down” or decelerated to a suitable EFSS speed before it can be stopped at the desired position. In this way, “ramping” allows us to dramatically reduce traverse time.

By starting in EFSS and then ramping up to slew, we can run for most of the traverse at the higher slew speed, and still come to a complete stop at the desired point without losing (or gaining) steps. Of course, the shape of the required velocity profile is dependent on the ability of the motor to accelerate the load.

Operational Limitations

There are certain inherent regions within which a stepper motor will not provide stable operation. At both the natural frequency of the motor, and the mid-frequency resonance region, stepper motors may oscillate noisily, lose steps or even stall. Electronic and mechanical means can be used to compensate for these effects, and they do present an added dimension to be considered in the application process.

Low-Frequency Resonance:

The low-frequency resonance region of a stepper motor is usually a narrow band centered between 80 and 200 steps per second (sps). In this region, the motor load must contain some friction, either inherent or added by the user, to assure stable operation. Although it is possible to calculate with some certainty the amount of friction required, system performance should always be verified by actual testing.

Mid-Frequency Resonance:

Mid-frequency resonance is the term used to refer to a region within the mid to upper stepping rates in which there is a steep drop-off in available torque. In this area, motor performance is extremely erratic and stalling can occur. Once this region is passed, normal operation resumes. The actual location and width of the mid-frequency resonance region is dependent on the type of control, the power supply voltage and the motor load conditions. However, speed / torque curves provided by the manufacturer usually indicate probable unstable areas. Although continuous operation in resonance areas is not possible without some type of damping, steppers can operate at these speeds momentarily during acceleration and deceleration.

Since resonance is a function of motor design, load characteristics and control circuitry, it can often be avoided, compensated for or even eliminated by a variety of techniques.

Ramping— If operation beyond the mid-frequency resonance region meets application requirements, it may be possible to ramp through it by properly matching motor to load. Since steppers are normally used in processes which require frequent acceleration and deceleration, the effects of resonance can generally be overcome.

Electronic Antiresonance Techniques—Various electronic methods are available to minimize resonance effects. A common

and relatively inexpensive technique is to “half-step” the motor by energizing the windings alternately one and two at a time. The motor takes two half steps to advance a full step angle. This produces smoother shaft rotation with reduced resonance effects.

When extended mid-frequency operation is unavoidable, more sophisticated antiresonance circuitry is needed to electronically dampen the instabilities that cause resonance. **Contact the motor manufacturer for more information.**

Mechanical Dampers—Several mechanical methods may be used to successfully overcome the effects of resonance. Viscous inertia, ferro-fluidic and eddy current dampers all operate on the principle that a sacrifice in the rate of acceleration produced by adding inertia produces increased momentum to cancel out oscillation in the resonance region.

Viscous inertia dampers are coupled to the stepper motor shaft opposite the load. A damping rotor rotates in a fixed housing filled with a viscous fluid. Once the motor is brought up to speed, the inertia sets up an added momentum which damps the oscillations in the resonant area. Ferrofluidic dampers create inertia in a nonmagnetic housing filled with magnetic particles. Energy is absorbed by the interaction of inertia, mass and housing. Eddy current devices substitute a cup made from conductive material (usually aluminum) for inertia and fluid. As the shaft rotates, eddy currents are built up in the aluminum cup. The damper then acts like a friction drag on shaft rotation and resists deviation from operating velocity.

Oscillation (Ringing): Another control system characteristic which can be a factor in positioning application is the tendency for stepper rotors to oscillate or “ring” when the pulse train is stopped. See Fig. 8-51. The ringing effect usually lasts

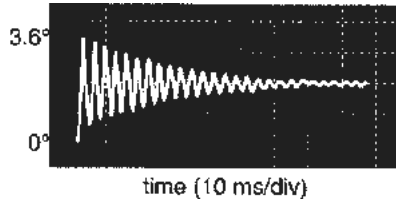

Fig. 8-51: Oscillation or “ringing effect” in an undamped stepper with no load.

no longer than a few hundred milliseconds. If this poses a problem, there are several ways to damp stepper motor systems.

Motor plugging circuits make it possible to electronically damp oscillation by “back-stepping” the stepper motor so that the rotor is at zero velocity when it reaches the desired final position. With delayed last step damping, the EFSS rate is selected so that the rotor overshoots the next to last position and reaches the final detent with zero velocity. It can then be held with little or no oscillation. Either method effectively reduces motor oscillation. See Fig. 8-52.

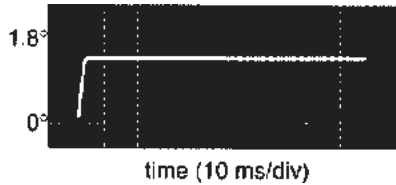

Fig. 8-52: Damped stepper response with no load attached.

If electronic damping is not applicable because system parameters vary (friction load or inertia), viscous inertia or friction-type dampers attached directly to the motor or load are excellent substitutes for electronic damping circuits.

Inertia: Inertia plays an important role in stepper applications. To obtain desired operation, the load inertia must be within the capability of the motor control system to accelerate and decelerate. Too much load inertia can cause the motor to lose steps or stall during acceleration. If

there is insufficient load inertia, the width of the resonance region may be too large.

To determine whether or not inertia will pose a problem in an application, first consult the motor control performance characteristics. If the intended operation is within acceptable design guidelines, inertia should be manageable. If the desired stepping rate is within the midfrequency region and the load system cannot be altered to allow a different stepping rate, more inertia may be added, or electronic means may be employed to arrive at a balanced combination of motor, load and control.

8.6 SOLID STATE ELECTRONIC (ACTIVE) CONTROL OF AC MOTORS

Advances in AC motor control have been slower to evolve than those for DC motors. As a result, AC motors have been slow to shake their image as constant speed drives. Nevertheless, progress is being made in many areas. Adjustable frequency AC drives are becoming more prevalent even for motors in the fractional horsepower range. These drives offer programmability of functions such as preset speeds, resonance compensation, and acceleration and deceleration rate control. Some sophisticated controls combine voltage and frequency control within the same unit. Other controls with specialized memory chips allow for keyboard-programmable, motor air gap flux adjustments.

It is beyond the scope of this Handbook to cover all of the latest innovations in electronic AC motor controls. However, familiarization with some of the basic solid state control methods is necessary.

Change in Frequency Method

As mentioned earlier, one way to control AC motor speed is by changing the power supply frequency. This is based on the speed formula for AC motors. The speed of an AC motor is related to the power supply frequency (Hz) by the equation:

$$RPM = \frac{120f}{P}$$

where:

RPM = revolutions/minute
(nominal synchronous speed)

f = frequency (Hz)

P = number of poles

Change in frequency has the advantage of providing stepless speed changes over a relatively wide range, and may be used with either synchronous or nonsynchronous induction motors. The synchronous motor has the obvious advantage of following the speed adjustment called for by the control. The nonsynchronous motor, even though it develops more torque per frame size, will slip in speed from the control setting depending upon motor load. The major disadvantage encountered with this method is the relatively high cost of the frequency changing power supply.

With an increasing number of manufacturers making three-phase adjustable frequency drives, the three-phase motor is gaining popularity in adjustable speed applications. This is particularly true where ruggedness, reliability and low maintenance are requirements.

Polyphase Power Supplies:

Small motors wound for operation with two-phase power supplies seem to be best suited for adjustable frequency applications. These motors will provide performance similar to three-phase designs, but the two-phase adjustable frequency power

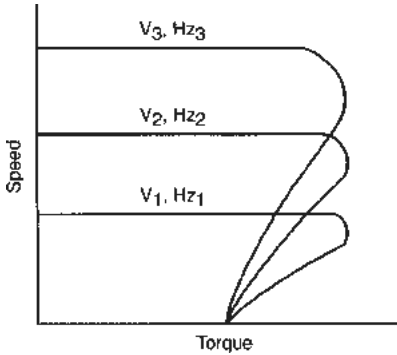

Fig. 8-53: Ideal speed / torque curves of a polyphase motor operated from an adjustable frequency drive ($V_3 > V_2 > V_1$ and $Hz_3 > Hz_2 > Hz_1$).

supply is more practical. Small two-phase motors can be optimized to operate over a range of 10 to 120 Hz by proper voltage adjustment. The voltage must be increased as the frequency is increased in order to compensate for the change in motor reactance. See Fig. 8-53.

One of two basic techniques are used to obtain adjustable frequency power:

1) *Six Step Method*—This method is named for the shape of the waveform it generates. See Fig. 8-54. Line voltage is rectified to an adjustable DC level. This voltage is then fed into an inverter which produces an alternating square wave voltage. At low motor speeds, the six step inverter can produce pulsations of torque and speed, called cogging.

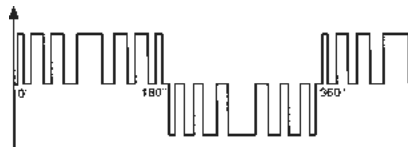

Fig. 8-55: Typical PWM voltage waveform.

Six step inverters also produce harmonics in the output waveform which cause motor heating without contributing to motor torque.

2) *Pulse Width Modulation (PWM)*—

With PWM, line voltage is rectified to a constant potential DC voltage. This DC voltage level is fed into a PWM inverter which generates a series of short pulses at varying widths to yield the voltage, frequency and harmonic relationship desired. See Fig. 8-55. The average voltage is determined by the width of the pulse (wide for high average voltage and determined by the rate at which polarity is reversed (which is much smaller than the pulse rate, so there are many pulses per cycle).

One disadvantage is that PWM inverters produce high frequency minor currents at the pulse repetition frequencies. The rapid high voltage pulses can also produce insulation stresses, and noise and vibration problems in motors.

There are several variations of these two techniques. Since they produce non-

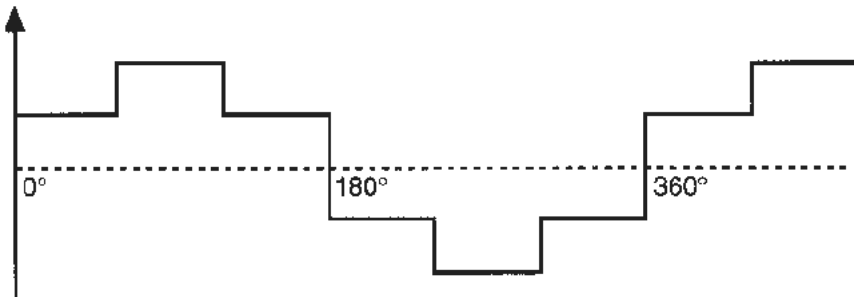

Fig. 8-54: Typical six step voltage waveform.

sinusoidal waveforms, they cause additional motor heating which may require that the motor be derated from the output that is obtainable from a pure sine wave.

Small polyphase motors are often rated for dual frequency (50/60 Hz) use at a single voltage level. These motors will run hotter on 50 Hz than 60 Hz because the input will be higher on 50 Hz and their ability to self-regulate will be reduced due to the reduction in speed to approximately 5/6 of the 60 Hz speed.

Single-Phase Power Supplies: On single-phase power supplies, split-phase start or capacitor start motors are least suitable for dual frequency operation. It is difficult to find a starting relay suitable for dual frequency operation. When a centrifugal cut-out switch is used instead of a relay it is difficult to obtain the correct operating speed. In addition, if a 60 Hz split-phase motor is designed to operate close to its temperature and magnetic limits, then operation on 50 Hz will not be satisfactory since the current and watts will increase excessively and the motor will overheat. This could even occur at no load.

The permanent split capacitor (single-phase power supply) motor presents a problem in adjustable frequency operation over a range of frequencies. This is primarily because the capacitor value should be decreased with an increase in frequency and vice versa. However, when specifically designed for the purpose, the permanent split capacitor motor is the best choice for operation in the narrow frequency range of 50 to 60 Hz.

When the frequency is changed from 60 to 50 Hz, the current in the main winding will increase and the current in the capacitor winding will decrease so that the total current may actually remain approximately the same regardless of the frequency. Generally speaking, any PSC motor can be

wound so that it will accommodate the same input power at 50 or 60 Hz.

However, a dual frequency, constant voltage design sacrifices power output compared with single-phase versions. Therefore, for a given frame size, optimized dual frequency motors will have lower hp ratings than single frequency motors.

Vector Control of Induction Motors

AC motors have long been used as constant speed drives while their DC counterparts have been employed in numerous variable speed and positioning applications. This phenomenon is due to the DC motor's inherent adaptability to variable speed techniques and its linear speed/torque characteristics.

This adaptability is a function of DC motor construction and the ability to control torque and motor field flux independently. We learned earlier that by weakening the magnetic field of a DC motor, the field current is also weakened and consequently, the back emf is reduced. If the armature voltage is held constant while weakening the field flux, motor speed increases. DC motors become very unstable at high speeds due to brush arcing and armature reaction. Therefore, high speed DC motors require special construction to overcome these inefficiencies.

AC motors which have no brushes and more rugged construction have been unsuitable for variable speed applications because their torque and field flux are interrelated. Any change in either one will cause a corresponding reaction in the other. Vector control (or field-oriented control) allows independent control of an induction motor's field flux and rotor current to achieve linear torque characteristics like those of DC motors. To do that, the motor control must regulate the instantaneous magnitude and phase of the stator currents

or voltages in order to develop a linear relationship between torque and slip frequency. This involves numerous calculations and algorithms. Although vector control techniques have been known for some time, they have only become cost-effective with recent advances in microprocessors and integrated circuit technology.

The instantaneous angular position of the field flux vector rotating at synchronous speed must be known for accurate vector control. This can be measured (direct vector control) or it can be estimated from the computed slip which is based on the rotor time constant, T_r (indirect method). The rotor time constant is a function of rotor resistance and inductance and can vary significantly from its nominal value depending on operating conditions. It is critical that T_r be tuned correctly. If it isn't, the calculated slip will be in error and consequently so will the field flux vector. If the estimated T_r is not matched to actual T_r , field orientation will be lost and the actual torque will differ from the expected torque. A popular method for calculating T_r is by using the inverse Gamma form model equivalent circuit, but that is beyond the scope of this *Handbook*. It suffices to say that vector controllers require extensive processing power in order to achieve effective results.

Machine tool spindle drives have benefited from the use of vector controlled induction motors. They can be operated at higher speeds than thyristor-controlled DC motors for increased application performance and they require less maintenance, both of which often justify the cost of the controls.

Switched Reluctance Motor Control

The switched reluctance motor was described in Chapter 4. It possesses qualities of both AC and DC motors. The switched reluctance motor has been

receiving more attention in recent years as a variable speed drive for the same reasons that vector control of induction motors has grown in popularity: faster processors and decreasing cost of building and implementing controls.

But unlike induction motors which are a staple in the industry, switched reluctance motors are not widely used nor understood by designers. Therefore, there is considerable controversy over the methods of controlling switched reluctance motors, especially in servo systems or four quadrant operation.

Since they possess AC motor qualities, they require signal processing in order to compensate for inherent nonlinear properties. Control algorithms are needed to smooth irregularities from the motor as well as from the rotor position feedback devices that are required. A considerable degree of wave shaping is also required on the input side of these motors.

Rotor position is a critical factor in controlling a switched reluctance motor. Transducers for measuring position and current add considerable cost to the system. Although there are several methods for estimating the rotor position, they are cumbersome and can often create undesired effects.

8.7 MOTOR CONTROL ENCLOSURE STANDARDS

Some motor controls are provided in separate enclosures for simple applications where the motor speed is controlled manually or where the motor control is used as a stand-alone device. Other times, a motor control is simply one element of a more complex motion control system and is mounted in a large central equipment enclosure with other process control equipment. In the latter applications, the

manufacturer may provide the control without an enclosure.

Motor control enclosures, like motors themselves, are rated and tested against safety criteria established by various third party standards organizations such as the National Electrical Manufacturers Association (NEMA) and Underwriters Laboratories (UL). Designing to these standards is voluntary and compliance to standards is at the manufacturer's discretion. When a control enclosure meets various third party standards, end-users are assured of certain safety and operating characteristics.

Standard UL-508 covers safety design requirements for industrial control equipment enclosures. UL-50 covers cabinets, cut-out boxes and junction boxes. NEMA has also established standards for industrial control equipment enclosures to meet a wide range of applications.

A brief overview of NEMA enclosure types is given below. If additional information or specific details are required about motor enclosure standards, the reader should contact the various standards organizations and industry associations listed in Appendix 1.

NEMA Type 1: This type of enclosure is suitable for indoor general applications under normal atmospheric conditions. Type 1 enclosures protect users from touching the equipment and protect the control from falling dirt.

NEMA Type 2: This is a general purpose indoor enclosure with drip shield protection to protect the control from falling liquid or dirt. It is not intended to protect against dust or internal condensation.

NEMA Type 3: These enclosures are for outdoor use and provide some protection from windblown dust, rain and moisture. They also protect the control from external ice formation. They will not protect against internal condensation or icing.

NEMA Type 3R: The same as Type 3, this enclosure only protects against falling rain, sleet and external ice formation.

NEMA Type 3S: Also the same as Type 3, this enclosure meets additional provisions for operating external controls when ice-laden.

NEMA Type 4: These enclosures are for indoor or outdoor use and protect against windblown dust and rain, splashing water and forcefully directed water from a hose. They do not protect against internal condensation or icing.

NEMA Type 4X: The same as Type 4, this enclosure provides added protection against corrosion.

NEMA Type 6: These enclosures are for indoor or outdoor use and can withstand temporary submersion in water at a limited depth.

NEMA Type 6P: The same as Type 6, this enclosure also has the ability to withstand submersion for prolonged periods.

NEMA Type 11: These enclosures are intended for indoor or outdoor use and protect against corrosive liquids and gases. They can be submerged in oil for added protection against fumes and gases.

NEMA Type 12: These enclosures are for indoor use and provide a degree of protection against dust, falling dirt and dripping noncorrosive liquids.

NEMA Type 13: These enclosures are for indoor use and provide a degree of protection against dust, spraying water, oil and noncorrosive coolant.

NEMA Type 7 (Class I, Groups A, B, C and D indoor): These enclosures are intended for hazardous areas as defined by the National Elec-

trical Code. They meet explosion, hydrostatic and temperature tests.

NEMA Type 9 (Class II, Groups E, F and G indoor):

These enclosures are intended for use in Class II hazardous areas as defined by the National Electrical Code. They also protect against the ingress of dust.

In addition to local standards, an international classification system has been established by the International Electrotechnical Commission (IEC) to rate the sealing effectiveness of electrical equipment enclosures. IEC-529 utilizes an alpha-numerical system. See Fig. 8-56. The letters "IP" stand for "Ingress Protection" and are followed by two numerical digits which indicate degrees of protection against solid objects and moisture.

The first digit indicates the degree of protection that the enclosure offers against solid object entry:

- 0 - No special protection.
- 1 - Protection from solid objects larger than 50 mm.
- 2 - Protection from solid objects not greater than 80 mm in length and 12

mm in diameter.

- 3 - Protection from entry by objects greater than 2.5 mm in diameter.
- 4 - Protection from objects greater than 1.0 mm in diameter.
- 5 - Protection from dust.
- 6 - Dust-tight.

The second digit indicates the degree of protection that the enclosure offers against moisture:

- 0 - No special protection.
- 1 - Protection from dripping water.
- 2 - Protection from vertically dripping water.
- 3 - Protection from sprayed water.
- 4 - Protection from splashed water.
- 5 - Protection from water jets.
- 6 - Protection from heavy seas.
- 7 - Immersion protection.
- 8 - Continuous submersion protection.

IEC-529 does not cover mechanical damage, explosions or harsh environmental conditions such as high humidity or corrosive fumes.







IP 54=		IP 54	
IP letter code		54	
1st digit		5	
2nd digit		4	
1st digit	Protection from solid objects	2nd digit	Protection from moisture
0	Non protected	0	Non protected
1	 Protected against solid objects greater than 50mm	1	 Protected against dripping water
2	 Protected against solid objects greater than 12mm	2	 Protected against dripping water when tilted up to 15
3	 Protected against solid objects greater than 2.5mm	3	 Protected against spraying water
4	 Protected against solid objects greater than 1.0mm	4	 Protected against splashing water
5	 Dust protected	5	 Protected against water jets
6	 Dust tight	6	 Protected against heavy seas and powerful water jets
		7	 Protected against the effects of immersion
		8	 Protected against submersion

Fig. 8-56: IEC-529 enclosure classification (IEC 60034-5 gearmotors)

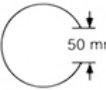

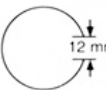
Feedback Devices

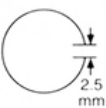
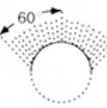
In Chapter 8, we explored the world of open and closed-loop motion control systems. We concentrated on motors and their associated controls and how they can be operated in either of the two modes. Closed-loop motion control systems depend on feedback transducers for the speed and position error signals which regulate the system's functions. Open-loop systems merely require an input signal to initiate some type of action.

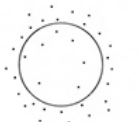
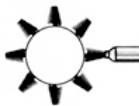
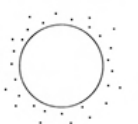
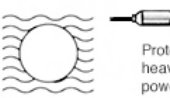
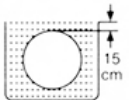
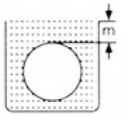
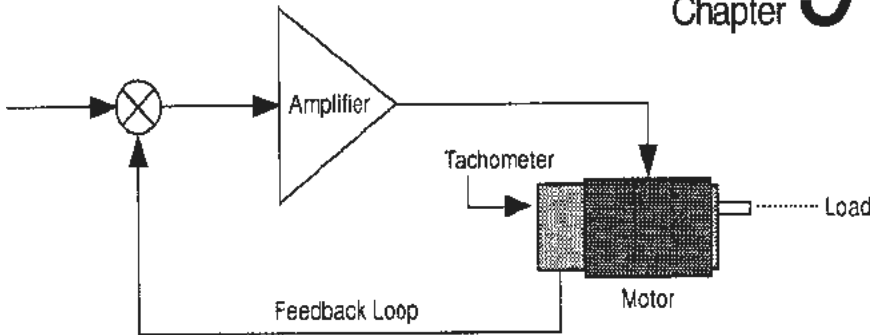
Sensors and feedback transducers provide information which the motor or system controller uses to stop, start, speed up, slow down or reverse a motor's direction of rotation. Sensors usually monitor the object or material being processed. They include photoelectric sensors, viscosity and flow sensors, temperature sensors and thermocouples, ultrasonic sensors, limit switches, force and torque transducers, and strain gauges.

In closed-loop systems, these devices measure a specific characteristic of the process and send a corresponding signal back to controller to initiate some form of actuator control. For instance, when an

object trips a limit switch, the controller may send a stop signal to a motor, shutting down the process. A flow sensor monitoring fluid pressure can provide the necessary feedback to cause a motor to open or close a valve.

Feedback transducers generally monitor the characteristic of the drive train for changes due to load variations or driveshaft position. These are the types of controls which we will examine in this Chapter. They include tachometer generators, encoders, resolvers, synchros and magnetic sensors. Accuracy of resolution, dynamic response, noise characteristic, temperature stability, environmental conditions and cost all play a role in deciding which feedback device should be employed in a specific application.

When considering price vs. performance, it must be stressed that the accuracy of the error signal cannot exceed the capability of the feedback device. It is important to weigh price / performance decisions carefully, especially if an application has tight control tolerances.

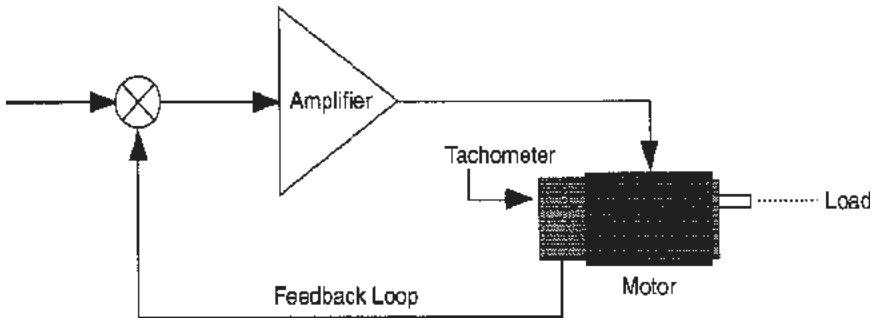

Fig. 9-1: Typical motor speed control feedback loop employing a tachometer.

9.1 TACHOMETER GENERATORS

A tachometer generator is an electro-mechanical feedback transducer that generates an analog voltage output directly proportional to the angular velocity at which it is driven. Tachometers may be used in simple applications to provide speed readout signals which are monitored on a meter and calibrated in RPMs. They are also used to deliver feedback signals in speed control systems or in velocity damping systems in position control. High performance tachometers are usually specially designed for servo applications. In less demanding situations, however, certain types of DC motors can act as tachometers by being driven mechanically to generate the desired feedback signal. Figure 9-1 shows a typical feedback control system loop employing a tachometer generator.

Tachometers can be separate devices or integral parts of a motor design. Tachometer-motor combinations may consist of a motor winding and tachometer winding on the same armature or they may utilize separate windings connected on a common shaft. The common armature type has the disadvantage of magnetically coupling the tachometer and motor windings, making it unsuitable for some high performance servo applications. Brushless tachometers are also available.

Tachometer design follows the same basic rules of DC motor design, except that certain critical requirements such as output voltage linearity, low voltage ripple and temperature stability must be maintained for feedback signal accuracy.

9.2 ENCODERS

Encoders are position and motion sensing devices that produce a digital signal which can be easily interpreted by a system controller or microprocessor. There are two distinct types:

- 1) rotary encoders, which sense the movement or position of drive train components rotating about an axis, and
- 2) linear encoders, which sense position or velocity of an arm moving parallel to an axis.

Rotary Encoders

Most drive trains produce some form of rotary motion. All motors, except for linear motors (Chapter 4), are rotary drives. In order to accurately control certain processes, the exact angular position of a rotating drive train must be known. Encoders are feedback transducers that sense angular displacement.

Most rotary encoders are available with optical or magnetic-type detecting elements. A contact-type has found limited use in some applications and laser-type

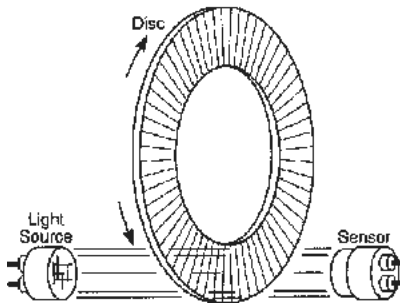

Fig. 9-2: Typical optical rotary encoder.

encoders are used in many robotic applications. Rotary encoders fall into two different categories:

- 1) incremental, and
- 2) absolute,

depending on their construction and the type of output signal they generate.

Optical Rotary Encoders: Optical encoders use the same basic components regardless of whether they are absolute or incremental in nature. A light source, usually an LED (light emitting diode), is used to pass light through slots in a rotating code wheel. The light transmission is interrupted by the pattern on the code wheel. The light is detected by a photoelectric diode mounted opposite the light source. A signal processor accepts the signals from the photoelectric diode and may convert them into binary or another code such as gray-scale code. Figure 9-2 shows a typical optical encoder configuration.

The physical characteristics of the code disk and the resulting output signal separate the incremental encoder from the absolute type. The incremental encoder passes a

beam of light through a series of small slits on a stationary mask and an identical pattern on a rotating disk. The photo diode detects a pulsed light source due to the alternate opening and closing of the slits resulting from the rotating disk. The light pulses can be counted to obtain the angular position, but to obtain direction information a second stage is required.

Incremental encoders can provide two channels of output pulses, displaced by 90 electrical degrees, known as an “A quad B” output system. See Fig. 9-3. The direction of rotation is determined from the occurrence of the edges of the A and B pulse trains. An A transition (0 to 1) occurs before a B transition during one direction of rotation, and vice versa for the other direction. As the shaft rotates through the null point, a reference pulse is generated.

Incremental encoders provide no indication of shaft position upon power-up. They must be rotated through the null point or provide a marker pulse in a third channel in order to obtain a reference position. This re-initialization or resetting of the system must be performed after a power interruption. Strong electrical interference can also cause miscounting. They are considered volatile position indicators and are best suited for short cycle and rate applications.

Absolute optical encoders use similar components except for the coded pattern on the rotating disk. See Fig. 9-4. The absolute encoder disk pattern provides an individual code for each position. Because

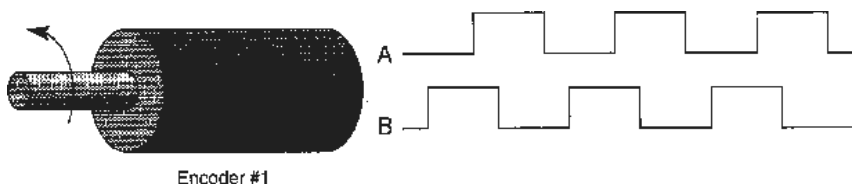

Fig. 9-3: “A quad B” output from an incremental rotary encoder.

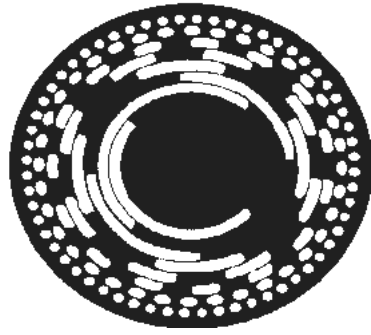
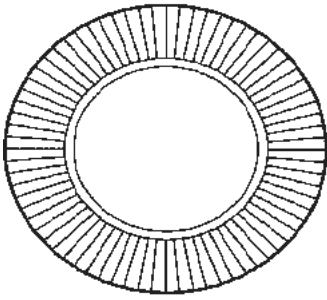

Fig. 9-4: Optical rotary encoder coded disks: a) incremental type (left), and b) absolute type (right).

no two codes are alike, the exact position is always known at start-up even if the system position was moved during a power outage. They are preferred in robotic applications where zeroing several axes can cause considerable production delay or where personal injury might occur if an erroneous position was detected.

Absolute encoders may provide very high resolution and accuracy. They are more expensive than incremental optical encoders and may produce outputs in three standard codes: binary, binary coded digit (BCD), or gray code. They are available in single-turn and multiturn configurations.

Single-turn absolute encoders produce a unique “word” output for each position over 360°. If the shaft rotates more than one full turn, however, the position information will repeat and the actual position cannot be determined unless the shaft turns are counted. Multiturn absolute encoders, on the other hand, are equipped with gear trains which keep track of the number of shaft turns. They produce a unique “word” output corresponding to the shaft location and the number of turns.

Magnetic Rotary Encoders:

A typical magnetic rotary encoder is illustrated in Fig. 9-5. It consists of a rotating magnetic disk or drum with magnetic

domains recorded at selected pitches. The degree of magnetic pitch defines the angular position. A magnetization system, similar to that used in conventional magnetic recording equipment, is used to saturate the permanent magnet material on the rotating disk. The angular position of the disk is synchronized to the charging pulses so that an entire array is written during one revolution. The disk is programmable, allowing for customization and changes.

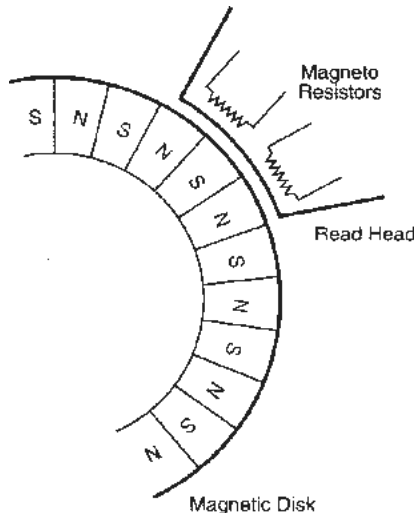

Fig. 9-5: Typical magnetic rotary encoder operation.

A magneto-resistive sensor, which changes its resistive value under the influence of the rotating magnetic field, detects the magnetization on the rotating drum and produces a corresponding output signal.

Magnetic rotary encoders provide good stability under varying temperature ranges, have low power requirements and offer good resolution in a small package size.

Linear Encoders

In some motion control applications, linear encoders are preferred over a combination of rotary encoders and lead screw arrangements. A linear encoder consists of a scanner and a glass or steel tape scale (depending on the length of the unit) which is fixed to a support. The fixed scale functions much like the coded disk in a rotary encoder. The scanner contains a light source, photocells and an additional graduated scale or reticle. See Fig. 9-6.

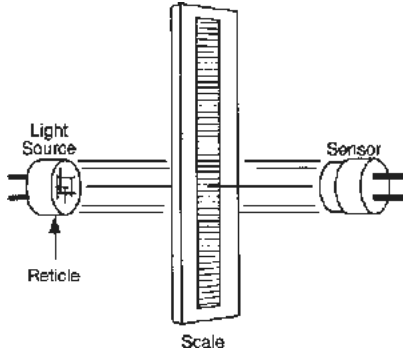

Fig. 9-6: Typical optical linear encoder operation.

Light is projected through the openings on the reticle and the fixed scale and is detected by photosensors. The fixed scale modulates the light as the scanner moves and produces sinusoidal photosensor outputs in quadrature (phase shifted by 90°). These outputs are compared to a reference voltage and combined to produce two

symmetrical square wave outputs in quadrature. The square waves are then counted to indicate speed and direction.

Linear encoders may be used very effectively in precision applications such as inspection tables, microlithography tools and printed wiring board drilling machines. They are subject to error because of the signal processing that takes place. Care must be exercised in mounting the scale. There are several rules of thumb for error correction in linear encoders and the manufacturer should be consulted to determine the degree of error which an application may inflict and how to minimize such errors before a linear encoder is selected and installed.

Resolvers and Synchros

Resolvers and synchros are analog output position transducers. Both resolvers and synchros look like small AC motors and function like rotating transformers. The output voltages of a resolver and synchro are uniquely related to the input shaft angle. They provide absolute positioning over the full 360° shaft rotation.

A resolver usually has a single-winding rotor and two stator windings positioned at right angles to one another. The rotor is excited by an AC reference voltage which in turn is coupled to the stator windings. See Fig. 9-7a. The relationship between the output voltage of a resolver and a reference input voltage ($V \sin \alpha$) is derived from the following:

$$V(S_1 \text{ to } S_3) = V \sin \alpha \sin \theta$$

$$V(S_4 \text{ to } S_2) = V \sin \alpha \cos \theta$$

A resolver-to-digital converter is required to convert the analog resolver output to two digital signals that are 90° out of phase. These digital outputs are required by the system controller and are a direct representation of the input shaft angle (θ).

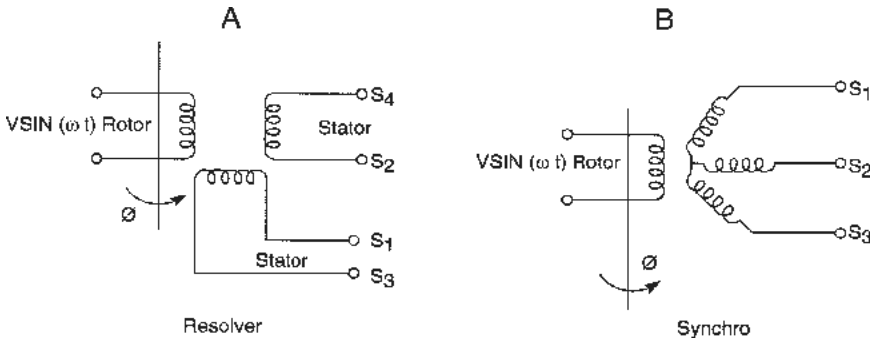

Fig. 9-7: Comparison of transducers: a) resolver (left), and b) synchro (right).

The synchro is represented in Fig. 9-7b. It consists of three stator windings in a Wye configuration. The relationship between input reference voltage $V \text{ SIN}\alpha$ and the synchro output voltages is:

$$V(S_1 \text{ to } S_2) = V \text{ SIN}\alpha \text{ SIN}\theta$$

$$V(S_3 \text{ to } S_2) = V \text{ SIN}\alpha \text{ SIN}(\theta + 120^\circ)$$

$$V(S_2 \text{ to } S_1) = V \text{ SIN}\alpha \text{ SIN}(\theta + 240^\circ)$$

A Scott T transformer is needed to convert the three 120° out-of-phase analog signals into two 90° signals so that a resolver-to-digital converter can be used to generate digital signals.

Since synchros and resolvers are transformers, they have inherent signal isolation and minimize electrical interference.

Another advantage of synchros and resolvers is that there is no signal processing performed at the drive train as with encoders. The resolver or synchro can be positioned where the angle needs to be measured while the r-to-d converter can be located in the cabinet with the controller or processor. This makes synchros and resolvers highly suitable for harsh manufacturing environments where electrical interference and temperature fluctuations could degrade an encoder signal.

Magnetic Pick-ups

A typical magnetic sensor is shown in Fig. 9-8. The sensing element consists of a wire coiled around a permanent magnet. Magnetic sensors detect the motion of moving ferrous objects that come within their magnetic field. When positioned near a moving gear, they will sense each tooth as it cuts through the magnetic field. The change of flux through the coil resulting from the passing ferrous object generates a voltage at the coil terminals.

Magnetic pick-ups are capable of relatively high resolution and can sense very small objects. When used to sense rotating shaft speed, the output of the sensor must be converted to RPMs by an analog-to-digital converter. They are particularly suited for high temperature applications since they contain no solid state components and they are highly shock-resistant.

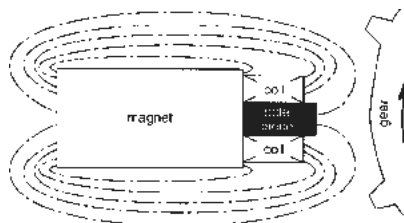
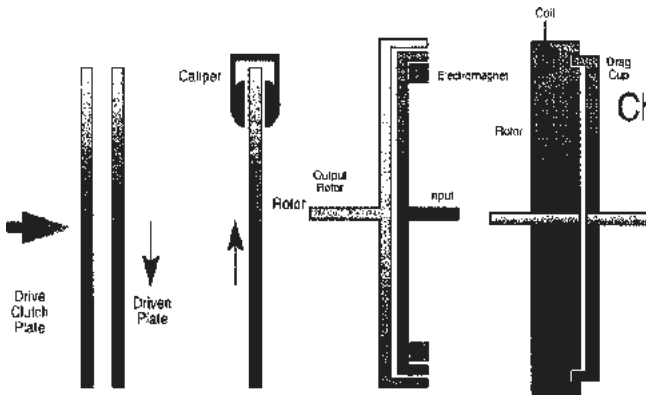

Fig. 9-8: Typical magnetic pick-up.

They do not perform well at extremely slow speeds because they depend on the rate of change of flux from one ferrous object to the next. At slow speeds, the output voltage drops below tolerable levels.

A variation of the magnetic pick-up is the eddy current sensor which detects ferrous and nonferrous objects. Eddy current sensors are not as simple as magnetic pick-ups because they require an oscillator and other circuitry in order to provide an output voltage. They do function well at extremely low speeds because they are not dependent on the rate of flux change like the magnetic pick-up.



Clutches and Braking Techniques

In many applications, it is desirable or necessary to accelerate the driven load smoothly from rest or to engage two independent drive trains in order to transfer power from one to the other. It often becomes necessary to bring a driven load down from its operating speed to zero speed (standstill) more rapidly than the normal coast time experienced when the motor is merely disconnected from its power source. Smooth acceleration, or the transfer of power from one drive train to another, is accomplished with clutches. Deceleration is accomplished by braking techniques.

Clutches and brakes are quite similar in functionality and method of operation. The basic difference is that in clutch applications, both drive trains are free to rotate. A brake, on the other hand, is a clutch with one member held stationary. In fact, the functionality is so similar that, for some applications, clutches and brakes can be combined into a single unit called a clutch-brake.

In less precise applications, electromechanical brake assemblies can be costly. In

these situations, dynamic braking can often be used to provide a cost-effective method of quickly reducing the speed of the driven load. We'll first look at electromechanical clutches and brakes and their actuation methods. Then we'll discuss the various dynamic braking methods for both DC and AC motors. Many of the clutches and brakes that will be discussed have limited or no use in fractional horsepower motor applications but are included so that the reader will have a better understanding of the scope of clutch and brake techniques.

10.1 ELECTRO-MECHANICAL CLUTCHES AND BRAKES

Electromechanical clutches are categorized by both the techniques used to engage or stop the load as well as by their method of activation.

The techniques include:

- 1) friction,
- 2) electromagnetic, and
- 3) mechanical lock-up.

Friction Techniques

This type of clutch or brake uses the friction developed between the two mating surfaces to engage the two drive trains or stop the load. One surface is made of metal and the other consists of a high friction composition material.

Disc Type: This type of clutch or brake consists of a friction plate and a disc. Figure 10-1a shows a simple plate style in which one plate is pressed against the other. The friction created by their contact causes one of two things to happen:

- 1) in the case of a clutch, both plates will turn or,
- 2) if one plate is held stationary as in a brake, the other plate will stop when contact is made.

Quite often a caliper arrangement is used for braking. See Fig. 10-1b. The pinching action of the caliper against the rotor makes this a very effective braking technique. Caliper disc brakes require high activation pressure and dissipate heat much

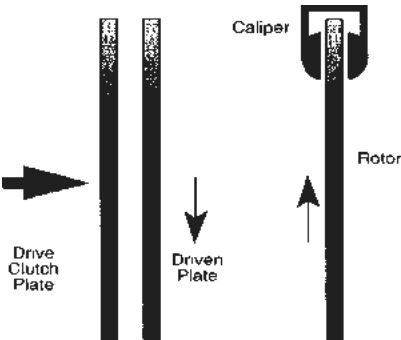

Fig. 10-1: Typical disc type clutch or brake mechanisms: a) plate type (left), and b) caliper type (right).

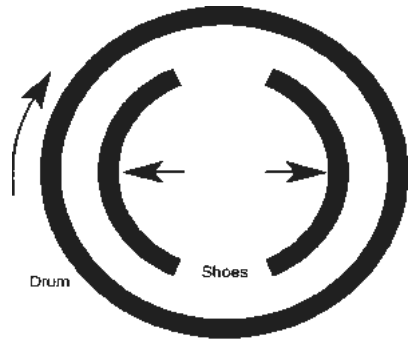

Fig. 10-2: Typical drum type clutch-brake.

better than plate style discs. They are also self-cleaning.

Drum Type: Drum type clutches and brakes have cylindrical shaped surfaces mounted on a common axis. See Fig. 10-2. The friction shoes either expand outward to contact the machined surface of the rotating drum or they can contract inward to engage a rotating shaft. As before, if both shafts rotate, the contact results in a clutch action. If the drum is stationary, the shoes provide braking action.

The contraction type is especially suited for high cyclic operation because centrifugal force causes rapid withdrawal of the shoes when released. Drum clutches and brakes transmit high torque.

Cone Type: Cone type clutches and brakes are a cross between disc and drum types. They provide the benefits of light engagement forces and high torque transfer but are difficult to disengage. Consequently, they are rarely used.

Electromagnetic Techniques

Clutches and brakes employing electromagnetism are classified as nonfriction type. They are used in applications requiring variable slip. They utilize the principles of electromagnetic

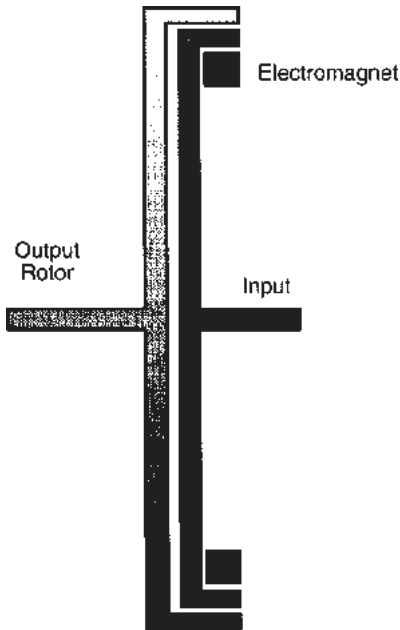

Fig. 10-3: Eddy current type clutch-brake.

attraction to cause engagement or to reduce load speed by adjustable slip.

Eddy Current Type: Eddy current type clutches are used in adjustable speed applications but cannot be operated at zero slip. As brakes, they have no holding power and are used primarily for drag loads. They have a tendency to run hotter than the other electromagnetic types and sometimes require additional cooling methods.

Eddy current type clutches and brakes consist of a stationary field coil, an input drum and a coupling pole assembly which functions as an output rotor. Refer to Fig. 10-3.

A coil sets up a magnetic field, linking the input drum with the output rotor. Eddy currents induced in the input drum create a new magnetic field which interacts with the magnetic field in the output rotor. A resulting coupling torque is created which is proportional to the coil current.

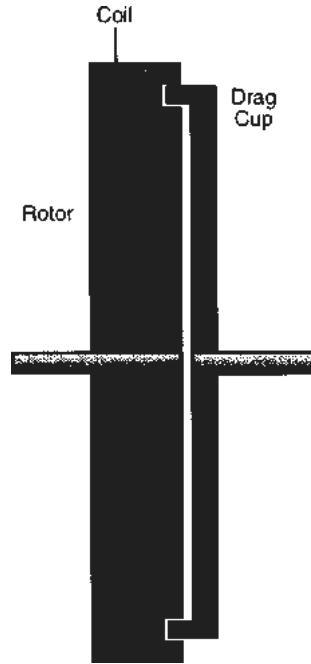

Fig. 10-4: Hysteresis type clutch-brake.

Hysteresis Type: This type of clutch provides constant torque which can provide varying degrees of slip as long as the heat dissipating capacity of the clutch is not exceeded. Torque is transmitted by hysteresis effect. Torque is independent of speed, except at high speeds. It is also a linear function of the control current except at low currents and near magnetic saturation. As a result, precise control can be achieved with hysteresis type clutches and brakes.

A coil on the input rotor generates a magnetic field in the rotor and the drag cup. Refer to Fig. 10-4. Torque is transmitted through the drag cup because the hysteresis effect in the drag cup causes the drag cup flux to change at a slower rate than the rotor flux. Hysteresis type clutches and brakes are used quite often in fractional horsepower motor applications.

Mechanical Lock-up Techniques

Mechanical lock-up techniques apply to clutches only and use direct mechanical connections between the input and output components to transmit torque. Operation of mechanical lock-up devices usually requires speed, a speed differential between input and output components, or a specific rotational direction. Many use centrifugal force, wrapping action or wedging action to lock the two members together, and are sometimes considered to be self-activating.

Square Jaw Type: A square jaw clutch is shown in Fig. 10-6. The square teeth of one member mate with the cut-outs on the other member to provide a positive lock-up which cannot slip. It is limited to low speeds (under 10 RPM) because of its nonslip characteristics.

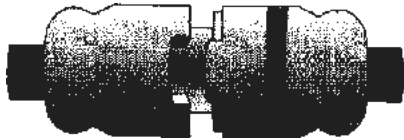

Fig. 10-6: Square jaw clutch.

Spiral Jaw Type: Because of its sloped surface design (Fig. 10-7), the spiral jaw clutch offers smoother running engagement than the square jaw type. It can be engaged at speeds up to 150 RPM. However, it has a tendency to freewheel, and can only run in one direction. Reversing the direction of rotation will cause disengagement.

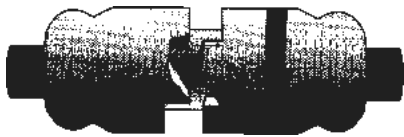

Fig. 10-7: Spiral jaw clutch.

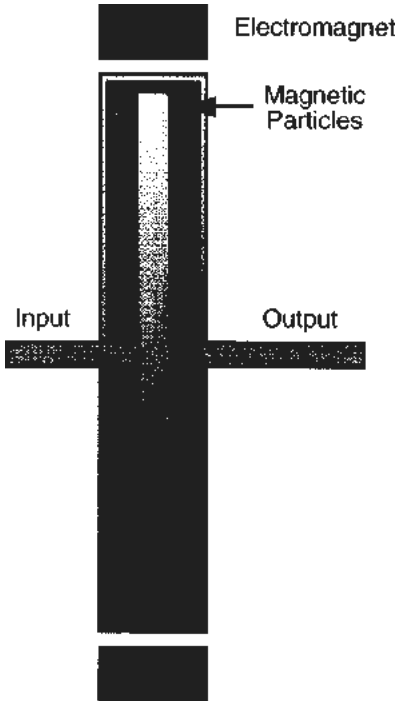

Fig. 10-5: Typical magnetic particle type clutch-brake.

Magnetic Particle Type: The input disc of a magnetic particle clutch-brake is located within the output housing. See Fig. 10-5. The space between the disc and the housing is filled with magnetic particles. An electromagnet surrounds both the input and output housings. Energizing the electromagnet causes the metallic particles to form a rigid bond between the two housings and transmit torque from one to the other.

The amount of particle bonding is controlled by the current flow and is directly proportional to the torque. The torque slip can be adjusted by varying the current flow in the coil of the electromagnet. These types of clutches and brakes are useful in variable speed tensioning and positioning applications.



Fig. 10-10: Wrap spring clutch.

Toothed Type: Toothed clutches combine the benefits of electrical, pneumatic or hydraulic actuation with positive mechanical lock-up. They can be engaged at speeds up to 300 RPM. See Fig. 10-8.

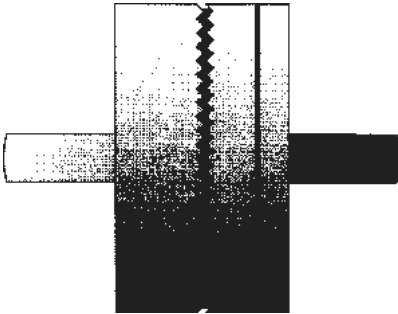

Fig. 10-8: Toothed type clutch.

Sprag Type: A sprag type clutch has an inner and outer race with sprags in between. See Fig. 10-9. Because of their shape and size, they wedge themselves between the races when rotation occurs in the proper direction. The wedging action locks the two races together and transmits torque from one shaft to the other. They are unidirectional.

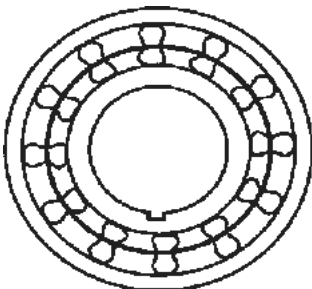

Fig. 10-9: Sprag type clutch.

Wrap Spring Type: This type of clutch uses a coiled spring to attach one shaft to the other. Rotation in one direction tightens the spring around the output shaft and transmits torque. Rotation in the other direction uncoils the spring and releases the output shaft. Refer to Fig. 10-10.

Roller Ramp Type: Rollers sliding on the ramped surfaces of a hub provide the means of transmitting unidirectional torque in these types of clutches. See Fig. 10-11. When actuated, the clutch causes the roll cage to position the rolls at the top of the ramp and engage the hub and sleeve. When the clutch is disengaged, the roll cage forces the rolls down the ramp away from the sleeve.

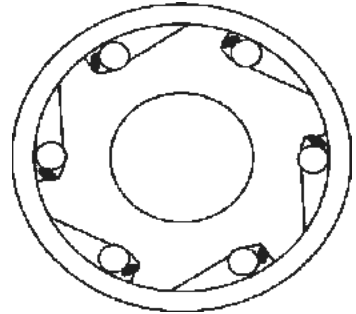

Fig. 10-11: Roller ramp clutch.

Actuation Methods

There are four basic methods used to actuate clutches and brakes:

- 1) electromagnetic,
- 2) mechanical,
- 3) pneumatic, and
- 4) hydraulic.

Electromagnetic is the primary method of actuation in fractional horsepower applications because it offers the most control and flexibility. The other methods of actuation will be discussed for completeness, but they are usually reserved for specific applications or higher horsepower motors.

Before choosing an actuation method, the applications engineer should ask several questions:

- 1) How much torque is needed?
- 2) What is the best available engagement method?
- 3) Does the application require electronic or remote control?
- 4) How much response time is needed?
- 5) Are there any special environmental requirements that must be satisfied?
- 6) What is the duty cycle?
- 7) What are the temperature requirements of the clutch or brake?
- 8) What is the maximum operating speed of the system?
- 9) What space or weight requirements must be satisfied?
- 10) What are the service life and maintenance requirements?

Based on this information, the best choice of clutch or brake type and actuation method can be determined.

Electromagnetic Actuation:

Extremely fast cycling rates are achievable through electromagnetic actuation. Its torque range is limited, compared to hydraulic and pneumatic actuated clutches and brakes.

Fractional horsepower motor applications often involve some form of automatic operation involving electrical commands. That is why electrical actuation is more common in these applications. Electrical actuation also works well in remote

applications where it would be difficult, impractical or too expensive to run the piping or tubing required for the other types of actuation.

A typical electrically actuated clutch or brake is shown in Fig. 10-12. One half consists of an armature attached to the drive motor or input shaft. The other half is an electromagnet embedded in an iron shell and covered with a friction pad. When voltage is applied to the coil of the electromagnet, it attracts the armature and engages the clutch. If both components turn freely, the unit functions as a clutch. If one is held stationary, braking action takes place.

Electromagnetic clutches and brakes can have rotating or stationary coils. Rotating coil types (Fig. 10-12a) use slip rings and brushes which can cause sparking, making them unsuitable for explosive atmospheres. The stationary field type with a fixed coil (Fig. 10-12b) eliminates this problem.

The simplest type of electrical actuator consists of a plug-in module which converts AC line voltage to DC and uses on/off switching circuits. More sophisticated controls include solid state modules with integral time delayed outputs. Some are equipped with torque adjustment controls for soft starts and stops.

Pneumatic Actuation: Air actuation methods are common in industrial applications involving larger horsepower motors. Compressed air supplies are readily available in most industrial settings. Pneumatic actuation requires piping or tubing as well as pressure regulators, filters, lubricators, control valves, exhaust valves and mufflers to control various aspects of the pneumatic system. This support equipment and the associated costs and maintenance they require are the main disadvantages of pneumatic actuation systems.

Hydraulic Actuation: Hydraulic actuation provides fast response and smooth engagement when control valves are used to control hydraulic pressure. Hydraulic pistons can deliver high torque requirements needed to operate heavy-duty clutches and brakes. Like pneumatic actuation systems, the piping and associated control mechanisms are the main disadvantages.

Mechanical Actuation: This is the simplest and least expensive form of actuation. Mechanical actuation depends on human strength to depress a pedal or move a lever, so force is limited to about 75 lbs. This limits torque transmission and cycling rates. Mechanical actuation is

usually reserved for vehicles and industrial equipment like cranes and hoists.

Centrifugal clutches which engage when a motor reaches a predetermined speed are also examples of mechanical actuation. Centrifugal clutches cannot be controlled externally, however.

10.2 DYNAMIC BRAKING

Motors should not coast more than a few shaft rotations after being de-energized. If the application requires precise braking, electromechanical brakes and clutches like those previously discussed should be used. In less critical applications, dynamic braking techniques can be employed.

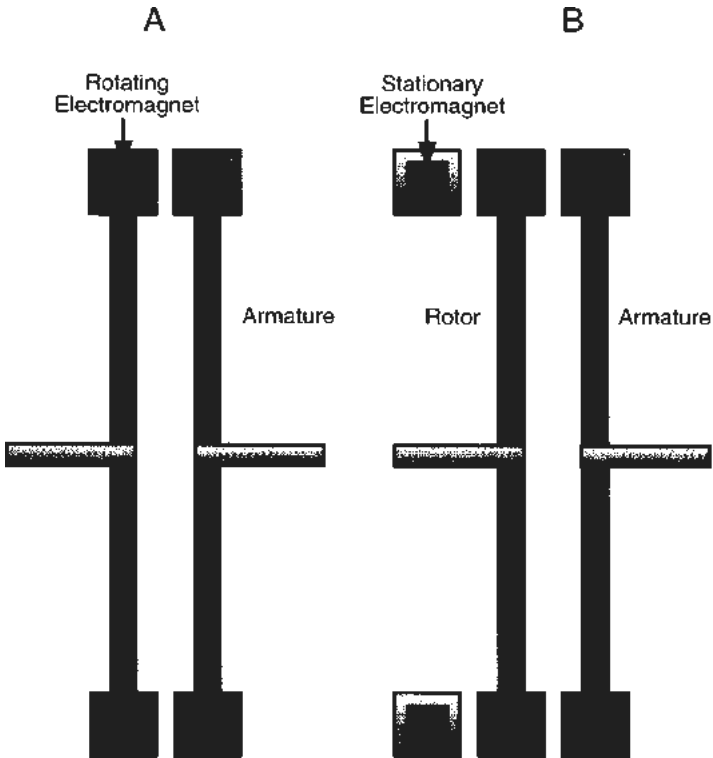

Fig. 10-12: Electromagnetic clutch: a) rotating coil (left), and b) stationary coil (right).

Dynamic braking is achieved by altering the connections to the motor with or without the aid of an auxiliary power source, depending on the motor type (DC or AC). In either case, the motor acts like a generator and the kinetic energy of the motor and the driven load is used to exert a retarding force to slow the forward rotation of the motor.

DC Motors

Various techniques are used to accomplish dynamic braking in fractional horsepower DC motors and gearmotors. Each will be explained in detail.

Shunt-Wound Field DC Motors: Perhaps the easiest motor to dynamically brake is the shunt-wound field motor. A shunt-wound motor is a DC brush-type machine with field and armature connected in parallel across a DC power supply. See Fig. 10-13. The interaction of the magnetic field set up by the field winding and the current flowing in the armature conductors produces torque or normal motor action.

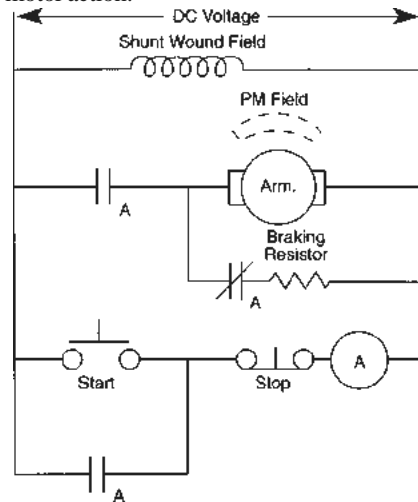

Fig. 10-13: Dynamic braking circuit for four-wire shunt-wound motor or two-wire PM motor.

A counter electromotive force (cemf) is generated in the conductors of any armature rotating in a magnetic field. While the unit operates as a motor, the cemf opposes the line voltage and limits the current in the armature winding to a value just sufficient to supply adequate output shaft power requirements. Braking is simply accomplished by disconnecting the armature from the power source and placing either a short or current limiting resistor across the armature terminals while the field coils remain energized.

At the instant this is done, the rotation will continue because of the inertia of the armature and its driven load. The armature rotating in a magnetic field will continue to have voltage (cemf) generated in it that will be proportional to its speed and the strength of the magnetic field. The armature circuit which is now closed by a short or current limiting resistor will have a current flowing in it opposite to that originally produced by the power source.

The reversal of current will produce a torque opposite to the original motor action and the motor will begin to reverse itself. However, during the reversing process, the speed in the forward direction will be rapidly reduced and so will the voltage generated in the armature. At the point of reversal or zero speed, the generated voltage is zero. The motor stops at this point since no current can flow and no torque is generated to continue the reversing process. The motor has been dynamically braked.

The rate of braking is controlled by the value of the shunting resistor. A small resistance will allow a large amount of current flow and, since the reversing or braking torque is proportional to the current, the motor and load will stop in a minimum amount of time. Some resistance is usually recommended to limit the severity of the braking action, especially with gearmotors.

NOTE: The field winding should be disconnected from the power source after the motor stops unless the field is meant to be connected continuously across the line at standstill.

Permanent Magnet Field DC Motors: Dynamic braking of PM motors is accomplished in the same way as the shunt motor with some additional advantages. The shunt motor cannot be dynamically braked to a stop in the event of a power failure because a field voltage must be present to generate the braking action.

With a permanent magnet (PM) motor, a power failure will not affect the motor's braking capability because its magnetic field (a permanent magnet rather than a coil) is not affected by a power outage. A normally closed relay or similar device across the armature will automatically function in case of a power failure, shorting the armature's terminals and initiating the braking action. This inherent characteristic is important, for example, on reel drives to prevent unwanted spillage of tape.

Figures 10-13 and 10-14 apply to PM field motors (except that the shunt field in Fig. 10-13 should be replaced by a permanent magnet field). Figure 10-14 illustrates the use of electronic components to achieve dynamic braking in a unidirectional

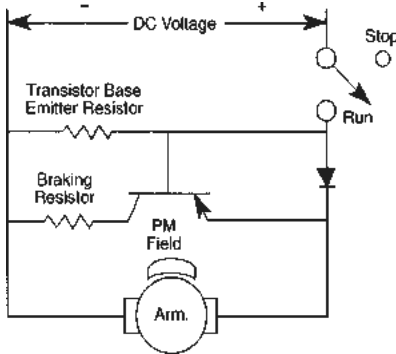

Fig. 10-14: Dynamic braking circuit for a unidirectional two-wire PM motor.

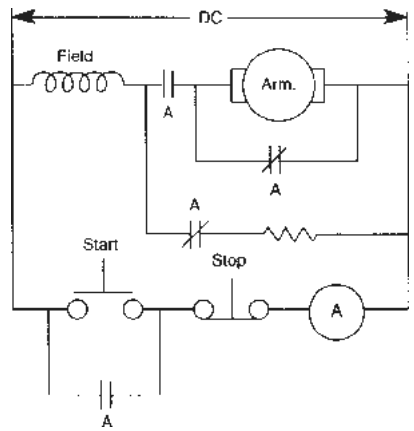

Fig. 10-15: Dynamic braking circuit for a four-lead series wound motor operated from a DC source. This may not function properly if the motor is operated from an AC source.

PM motor application. The diode biases the transistor off in the run mode. When the armature no longer draws current from the line (brake mode), the transistor will conduct because the polarity of the armature cemf is opposite to the line voltage.

Series Wound Motors: Universal (AC/DC) or series wound motors may be dynamically braked in several different ways. One method that applies to a four-lead series wound motor is quite similar to that described for the shunt-wound motor. See Fig. 10-15. The only difference is the addition of resistance in series with the much lower resistance of the field circuit to prevent excessive heating during frequently repeated or extended braking cycles. This method is not generally successful when the motor is powered by AC as the motor tends to continue running without braking because of repulsion motor behavior.

A three-lead, reversible series wound motor can be very conveniently braked by simply connecting the armature across the opposite set of field coils. See Fig. 10-16.

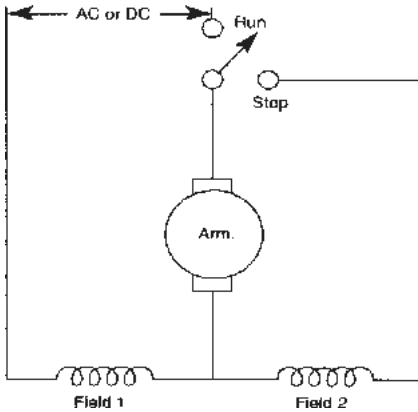

Fig. 10-16: Simplified dynamic braking circuit for a three-wire series motor.

It should be noted that the series wound motor scheme shown in Fig. 10-16 is “self-excited” since it brakes the motor without the need for any external source of power. However, because of the self-excited feature, braking by these methods is less consistent or reliable than the schemes presented for the shunt or PM motors in Figs. 10-13 and 10-14.

Compound Wound Motors:

A compound wound motor, having characteristics of both a shunt and a series wound motor, can be braked by:

- 1) a shunt or series braking circuit,
- 2) a self-excited series wound braking circuit, or
- 3) a combination of both.

However, because of the slower speed of the compound wound motor, the shunt-wound braking circuit is preferred.

Plugging as a Means of Braking

Reversing a motor by reversing the power to the armature while the field remains connected is called “plugging.” This

technique can be used to brake a motor if the power to the motor is removed at the point when the armature passes through zero speed in its attempt to reverse itself.

Plugging is more severe than the braking methods described earlier because the voltage across the armature (in the case of a shunt motor) and across the entire motor (in the case of a series motor) is approximately twice its normal value at the instant of reversal. The generated voltage in the armature is added to the line voltage from full speed down to zero. Under normal running conditions, the generated voltage (cemf) opposes the line voltage.

Plugging is not always recommended as a means of braking. In wound field motors, for example, the braking torque generated is no longer proportional to the high armature current which is drawn. Excessive armature heating and brush arcing occur without the advantage of significant increases in torque.

In the case of PM motors, the coercive force of the magnets may be exceeded, causing a resultant decrease in magnet strength. If plugging is contemplated, the motor manufacturer should be consulted to establish motor limitations.

Other Considerations

Relays, switches and electronic devices shown in Figs. 10-13 through 10-16 are meant to suggest only some of the possible ways of braking the motors discussed.

Before using relays, switches and contactors in DC circuits, check that the devices have a DC rating of sufficient capacity. It is also important during the braking action that these devices be equipped with “break before make” contacts. Overlapping of the breaking and making functions can cause problems.

Some applications require that the holding torque be continued after the motor has stopped rotating. Of the braking circuits

described, the only one capable of providing a reasonable holding torque for a wound field motor is the circuit in Fig. 10-13. Permanent magnet motors have inherent holding. The strength of both depends upon the slot effect of the armature.

The nature of the load is often a vital factor in dynamic braking applications. Caution must be exercised in applying motors which are to be dynamically braked or plugged. In such applications, high currents and dynamic mechanical forces are generated during the braking period. For safety reasons, the thermal and structural capabilities of the drive system should not be exceeded. Dynamic braking of high inertia type loads require additional consideration because of the mechanical and thermal strains which can be induced in both the motor and other associated torque transmitting components.

While temperature rise is important in the normal operation of a motor, it is even more important in the dynamic braking of the motor. Since the braking torques generated with some schemes are higher than normal running torque, the energy which the motor must dissipate rises correspondingly.

Brush life can be expected to decrease when the frequency or duration of dynamic braking is substantial. Special brushes are usually required.

AC Induction Motors

We will restrict this discussion to those AC motors which utilize a nonenergized rotor typically found in small motors. In most cases, this means some form of a squirrel cage rotor except for the capacitor hysteresis type which uses a permanent magnet type rotor. In most cases, no distinction will be drawn between a synchronous and a nonsynchronous motor since any braking method discussed usually

will be applicable for either version in a particular winding type.

In general, AC motors are dynamically braked by removing the AC power from the motor and substituting DC. When this is done, the motor is very similar to the DC shunt motor described earlier. The stator, with DC applied, is similar to the field winding of a shunt motor and the squirrel cage rotor is similar to a shorted armature in the braking mode. In essence, the motor now acts like a DC generator with a short-circuited armature.

The electrical output of the generator has high circulating currents in the shorted rotor bars. The mechanical input of the generator is the kinetic energy of the rotor and the connected load. This rotational energy is dissipated in the form of heat (in the rotor) when the motor is quickly brought to a stop. The source of DC for braking purposes can vary from batteries and highly filtered supplies, to full wave and half-wave sources. DC may also be supplied by a charged capacitor. The choice is dependent on economics and the degree of braking required. Pure DC is best but more expensive to provide than rectified or nonpure DC.

Whether one or all of a motor's windings are used to brake, it is also a question of economics and power supply availability. "Plugging" may also be used to brake AC motors. Again, plugging consists of reconnecting the motor (while running) so that it wants to reverse itself. However, at zero speed (before the motor can rotate in the opposite direction), the power is removed. This method is limited to those motors which are capable of reversing while running.

A third method of braking small AC motors, called "capacitor shorting," is limited to permanent split capacitor (PSC) motors of the highslip nonsynchronous and hysteresis synchronous types. The procedure is to short the capacitor, placing

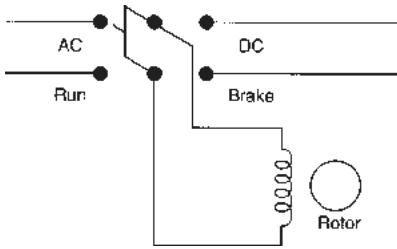

Fig. 10-17: Dynamic braking circuit for shaded pole motor.

both the main and the capacitor windings directly across the AC line. This method eliminates the rotating field associated with these motors and its torque producing capabilities. The two windings (main and capacitor) must be identical for the capacitor shorting method to be effective.

Shaded Pole Motors: A shaded pole motor is normally unidirectional with only one stator winding connected to the AC line. The only way to dynamically brake this motor type is to apply some form of DC in place of AC. See Fig. 10-17. Because of low motor impedance on DC, voltage must be removed immediately after braking (unless the DC is low enough that it won't overheat the winding). An acceptable continuously applied power level for braking can be obtained from the motor manufacturer.

Split-Phase Motors: Motors with split-phase windings employ centrifugally operated switches or starting relays

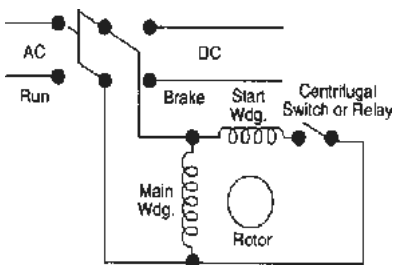

Fig. 10-18: Dynamic braking circuit for a split-phase motor.

which serve to "cut out" or disconnect the starting windings from the electrical supply when the motor has come up to 75% of running speed. To prevent burnout, starting windings are intended to be connected to the line for no more than a few seconds.

Since it is not normally recommended that these motors be reversed while running, the only feasible way to dynamically brake a split-phase motor is to apply some form of DC in place of AC as in Fig. 10-18. Again, because of low motor impedance, the DC voltage should be less than the AC. The braking voltage should be removed immediately after braking, since the drop in speed will cause the centrifugal switch or the start winding relay to reconnect the starting winding.

An electrolytic starting capacitor, in series with the starting winding, is recommended for this type of operation, since it would overcome the starting winding heating problem by blocking the DC power (the capacitor would also tend to provide additional starting torque on AC).

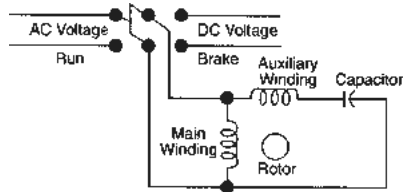

Fig. 10-19: Dynamic braking circuit for permanent split capacitor motor using main winding only for braking.

Permanent Split Capacitor Motors (including hysteresis synchronous): Several different braking methods can be considered for permanent split capacitor (PSC) motors. DC can, of course, be applied. Figure 10-19 shows that the capacitor will prevent the auxiliary winding from being used for braking because the capacitor blocks the flow of DC. In order to use the second winding, a three-pole or three-contact switch must be used to provide either a

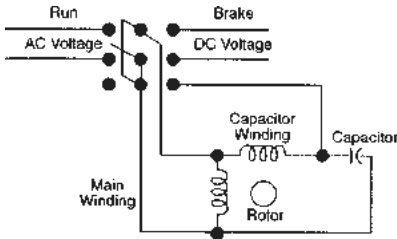

Fig. 10-20: Dynamic braking circuit for permanent split capacitor motor using windings in parallel for braking.

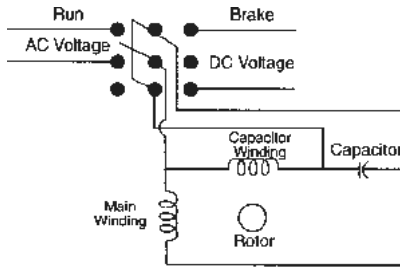

Fig. 10-21: Dynamic braking circuit for permanent split capacitor motor using windings in series for braking.

parallel or a series winding arrangement as shown in Figs. 10-20 and 10-21.

The “plugging” method can also be used on permanent split capacitor (PSC) motors which can be reversed while running. This is usually restricted to nonsynchronous designs using a high slip rotor and to hysteresis synchronous motors. Plugging can be accomplished by reversing either wind-

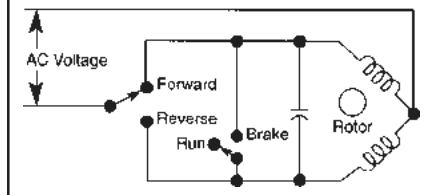

Fig. 10-22: Dynamic braking circuit for permanent split capacitor motor using capacitor shorting method.

ing. However, the main winding is preferred to avoid high voltage problems associated with the capacitor.

On small motors (approximately 1/75 hp or smaller), the “capacitor shorting” method can be used when the main and capacitor windings are identical. As with plugging, “capacitor shorting” is not applicable to low slip nonsynchronous motors or reluctance synchronous motors. As the size of the motor increases, this braking method becomes less effective and there may be a tendency to “creep” or to continue to rotate slowly at some very low speed. The capacitor shorting method is illustrated in Fig. 10-22.

Three-Phase Motors (Poly-phase): A three-phase motor may be dynamically braked by applying DC or by plugging. For a Wye or a Delta-connected motor, the braking circuit is shown in Fig. 10-23. In order to plug a three-phase motor for braking purposes, two input leads

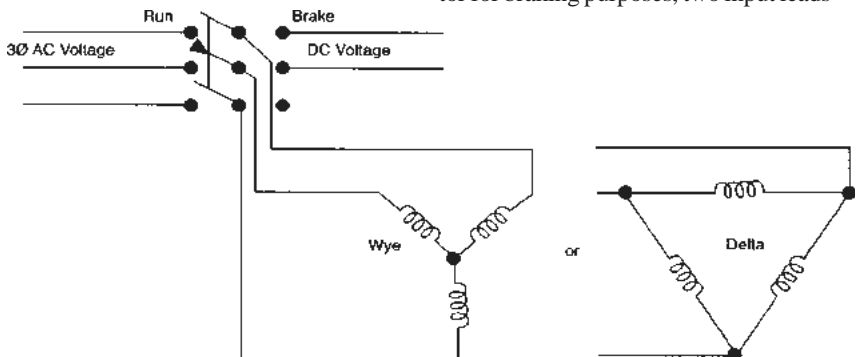

Fig. 10-23 Dynamic braking circuit for three-phase motor.

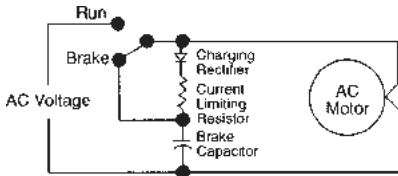

Fig. 10-24: Dynamic braking by capacitor discharge method.

must be reversed. At the point of zero speed, the motor is disconnected from the AC line.

The DC Supply

All AC motor types can be braked by applying DC to the windings. It was stated earlier that pure DC is more effective than rectified AC. It should be noted that some motors (PSC type) may continue to rotate at very low speed if braked by a half-wave supply. The effectiveness of any combination cannot always be predicted, so some trial and error tests should be conducted to establish the best circuit for each application. In some cases, DC may be merely supplied by the discharging of a capacitor. Figure 10-24 shows how a capacitor may

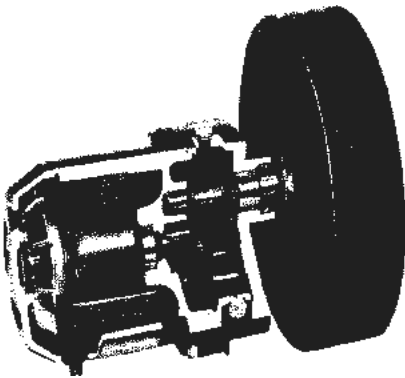

Fig. 10-25: Parallel shaft gearmotor (helical and spur gearing) with inertial load on output shaft.

be charged during normal running and then used to supply the DC voltage necessary to stop the motor in the braking mode.

Other Considerations

Holding torque must be considered with AC motors. AC motors are not very effective at holding the load after bringing the speed down to zero. The best holding characteristics are provided by reluctance synchronous motors. Because of their construction characteristics, reluctance type rotors will tend to lock into preferred positions. Of course, if any of the motors discussed are energized to maintain holding power, the electrical input must be low enough to prevent winding and lubricant overheating.

Gearmotors

Gearmotors must be given special consideration, particularly if they are to be used to dynamically brake inertial loads. Because of the high kinetic forces generated, gearing and other machine elements may be damaged if not selected and applied properly.

It is important to remember that the gearhead of a gearmotor is positioned between the inertial load and the motor's rotor. Because an inertial load "wants to keep on rolling" and backdrive a gearhead after the normal forward driving power is removed, both the inertia of the motor's rotor and an external inertial load can subject the gearhead components to dynamic stresses that exceed their design capabilities. Therefore, the dynamic braking of gearmotors driving inertial loads must be carefully analyzed.

When considering the dynamic braking of external inertial loads, it is useful to calculate the effect of the load as seen at the output shaft of the gearhead. Figures 10-25 and 10-26 show inertial loads (flywheels) directly connected to gearmotor

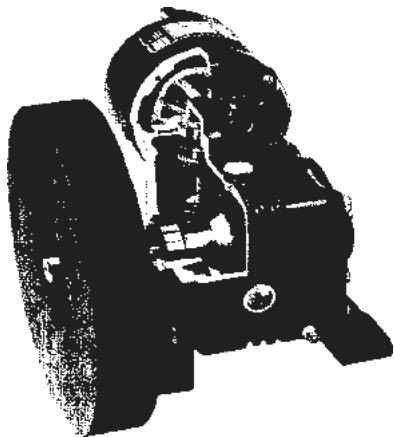

Fig. 10-26: Right angle worm gearmotor (two stages of worm gearing with inertial load on output shaft).

output shafts. It is also possible for considerable inertia to be “seen” by the gearhead in applications employing pulleys and belts (or sprockets and chains) in the drive system. If the output shaft is not directly coupled to the driven load (with speed altering elements separated from the gearhead), it will be necessary to calculate the equivalent inertia at the gearhead driveshaft using Equation 1 in Fig. 10-27.

Equation 1 shows that speed reductions beyond the driveshaft reduce the inertia seen by the gearhead output shaft. Speed increases have the opposite effect according to the square of the speed ratio. Equation 1 is useful for analyzing the effects of speed changes due to gears, belts or chain drives coupled to the gearmotor output shaft. Equation 2 illustrates the calculation of inertia for simple discs like the flywheels shown in Figs. 10-25 and 10-26.

Estimating Torque During Dynamic Braking: If a gearmotor is required to dynamically brake an inertial load from full (normal) speed in a specified period of time, one must consider whether the gearhead would be capable of absorbing the stored kinetic energy of the inertial

load during the braking period (as opposed to its normal function of transmitting the torque necessary to drive the load).

Equations 3a and 3b in Fig. 10-27 provide useful approximations for analyzing the effects of inertial loads when considering dynamic braking of gearmotors. Equation 3a is a general equation, while Equation 3b approximates the external braking torque required to bring the system to rest in the period (d_s) after the electrical power is disconnected from the motor (but dynamic braking not yet applied). Equation 3a is derived by assuming that the kinetic energy of a mechanical system, driven by a gearmotor, uniformly decelerates and is converted into work done (dissipated energy). In addition, Equation 3b ignores the inertia of gearhead components and does not consider additional dynamic loading imposed due to gearing backlash, or system misalignments and inefficiencies.

Note that Equation 3b shows that two inertial components are of major consideration:

$$WK_r^2 \times R^2 \text{ (internal inertia)}$$

and

$$WK_{lds}^2 \text{ (external inertia)}$$

When the internal inertia component is significantly larger than the external inertia component, it is feasible to dynamically brake the load through the motor winding. However, if the external inertia component is larger than the internal component, the load should be externally braked or clutched.

If the internal inertial component in Equation 3b is disregarded, it is apparent that for a given output speed, the inertia of the external load (WK_{lds}^2) and the braking interval (d_s) have great torque multiplying possibilities that can be fed into the gearhead. A gearmotor which performs acceptably at its rating when driving a load forward can easily fail due to excessive loading imposed during dynamic braking

$$\text{Equation 1: } [WK^2]_{(lds)} = [WK^2]_{(ls)} \frac{N_l}{N_{lds}} \left(\frac{\text{-----}}{N_{lds}} \right)^2$$

Where:

$[WK^2]_{(lds)}$ = inertia of the external load as seen by the driveshaft at its speed.

$[WK^2]_{(l)}$ = inertia of the load at its driven speed.

N_{lds} = speed of the driveshaft (revolutions / minute)

N_l = speed of the load (revolutions/minute)

$$\text{Equation 2: } [WK^2]_c = \text{weight (lbs)} \times \frac{[\text{radius(inches)}]^2}{2}$$

where:

$[WK^2]_c$ = inertia of solid cylinder or disc rotating about its own axis

NOTE: Many handbooks provide formulas for calculating the inertia of other geometric shapes.

Equation 3:

$$\text{a) } T_{ds} = \frac{(I_{ds}) (N_{ds})^2}{573 (\Delta_{ds})} \quad \text{or: *b) } T_{ds} = \frac{[(WK^2_r \times R^2) + WK^2_{lds}] (N_{ds})^2}{221,185 (\Delta_{ds})}$$

where:

T_{ds} = indicated torque required to bring the gearmotor driveshaft to rest during braking (lb-in)

I_{ds} = inertia of the entire mechanical system as seen by the gearmotor driveshaft

WK^2_r = internal inertia contributed by the motor's rotating member (rotor or armature) (lb-in²)

R = ratio of the gearmotor's gearhead

WK^2_{lds} = inertia of the external load seen by the gearmotor driveshaft (lb-in²).

N_{ds} = gearmotor driveshaft speed (RPM)

Δ_{ds} = driveshaft revolutions during the braking period

221.185 = A constant associated with inch system with inch system units.

Note: If SI units are used (newtons and meters instead of pounds of force and inches), the constant becomes 5,615.

*When $R = 1$, Equation 3b applies to nongear motor.

Fig. 10-27: Formulas for calculating the effects of inertial loads on gearmotors.

(i.e., the backdriving torque caused by an inertial load can exceed the forward driving torque and be beyond the capability of the gearhead).

Consider what happens when a gearmotor is forced to dynamically brake a relatively high external inertial load. An external inertial load on a gearmotor tends to "backdrive" the motor through the gear-

head. Because the electrical braking torque applied to the rotor is resisting rotation, an almost instantaneous torsional binding effect occurs in the gearhead. Under this condition, the motor winding is unable to absorb all of the stored kinetic energy of the rotating load and the remainder must be absorbed by the torsion and deflection of the various gearhead members, including

the axial movement and bending of the motor's rotor (the gearhead, in effect, becomes a mechanical spring).

The amount of energy absorption of each of the gearhead members involved is a function of their respective stiffness. Therefore, the stored kinetic energy of the load must be dissipated or absorbed by the gear teeth, intermediate gearshafts (if more than one stage), preload washers, the driveshaft and gear housing. Moreover, some of the kinetic energy is dissipated as heat, due to friction from such sources as the rotor and gearshaft bearings sliding in their bores.

Considerations with Spur and Helical Gearing: This type of gearing is common to parallel shaft or in-line (concentric shaft) gearheads. In fhp gearmotors, such gearheads typically have recess action type gearing which provides advantages when driven forward, but offers relatively greater frictional resistance than standard gearing when driven backwards. The resistance to backdriving manifests itself as a locking effect. It follows that the amount of resistance to backdriving increases with the number of stages of gearing. Gearheads with many helical and spur stages offer considerable resistance to backdriving.

Special Considerations with Worm Gearing: Dynamic braking of gearmotors with worm gearing presents additional considerations that do not exist with spur or helical gearing. A primary condition peculiar to worm gearing is the possible self-locking effect. ("Self-locking" is a term that describes an inherent characteristic of certain worm gears that prevent them from being backdriven. The slow speed shaft cannot be driven by an applied force.) In worm gearmotors, self-locking is a characteristic of higher gear ratios (typically greater than 15:1).

It is possible that during dynamic braking, gearing that is normally non-self-locking will lock. This can occur when the lead angle of the worm gear in the lower ratios is such that during dynamic braking, the friction in the gearing increases to the point where self-locking occurs. At the moment of locking, the contacting gear teeth and other gear train parts must dissipate the energy of the load. For applications where the braking forces exceed the shear strength of the gear teeth, failure will occur. Braking forces slightly under the shear strength of the gears and other parts will not show up as immediate failure, but can severely shorten gearmotor life through fatigue.

General Guidelines for High Inertia Gearmotor Applications: Dynamic braking of high inertial loads on gearmotors requires that the energy be absorbed or stored in the various gear train parts, which act like springs. A significant decrease in the stresses imposed on these parts can be effected by utilizing a torsionally resilient coupling (the effect is that of a torsional spring) or clutching that disconnects or limits the transmitted torque. Protection of the gear train members can also be accomplished by stronger gearhead parts, or by reduction of external inertia or load speed.

A good general rule to follow in applying dynamic braking to gearmotors is to use the minimum power for braking necessary to obtain the desired results. If it is required that the maximum allowable coast is to be held to 90 degrees at the driven shaft, it would be unwise to apply dynamic braking that limits the coast to a much lesser amount.

For the same reason that temperature rise is an important consideration under normal operating conditions, it is even more critical when dynamic braking is applied. If dynamic braking is required at

frequent intervals, operating temperature of the gearmotor and its lubricants would be higher than that of a nondynamic braking application with the same load. It is better to limit the braking so it will not exceed the allowable temperature rise of the winding or gear lubricant.

Adhering to these guidelines results in a cooler running, more service-free gearmotor, and places lower stresses on the gears and other mechanical components affected by dynamic braking.

10.3 EVALUATION OF DYNAMIC BRAKING METHODS

In the majority of motor and gearmotor applications, the dynamic braking capability of the motor is normally not the determining factor in the motor selection. Voltage, frequency, speed, torque, etc. are usually more important considerations in establishing whether the motor should be an AC or DC motor, or one of the particular types of AC or DC construction.

Under these circumstances, obviously, one accepts the braking capability that the particular motor offers. This generally presents no problem since all winding types and most of the dynamic braking methods described substantially reduce the stopping time and satisfy the majority of the less critical braking applications.

For example, a 1700 to 1800 RPM NEMA 42 frame motor (approximately 4.5" diameter) typically would coast from 40 to 120 revolutions when the power is removed without the aid of dynamic braking. With dynamic braking, the rotor would come to a stop within one to six revolutions with no load attached (except for gearing). Any load would, of course, reduce the stopping time if it were frictional

in nature and would increase it if it were highly inertial.

The previously mentioned range of stopping times without dynamic braking may seem excessive, but it is based on a number of different motor types, each of approximately the same horsepower level. This criteria results in differences in rotor lengths and construction which, along with the differences in windings, provides an even wider stopping range when dynamically braked.

As might be expected, a smaller motor would stop more rapidly than a larger motor. A 1700 to 1800 RPM 32 frame motor (approximately 3.5" diameter) would typically stop in about half the time taken by the larger 42 frame motor, or 20 to 60 revolutions without dynamic braking and 0.5 to 3 revolutions with dynamic braking (at no load but with gearing included).

Since the time to stop a rotating part is directly proportional to its inertia, the smallest possible motor should be used to drive the load where fast braking is desired. Motors with centrifugal switches and high density rotors should be avoided (since their relatively higher inertia in small motors may be significant).

Although we have limited our discussion to stopping time using a speed of 1700 to 1800 RPM, it should not be forgotten that the kinetic energy of a rotor is proportional to the inertia times the speed squared. Therefore, the speed of the rotor should be kept to a minimum for best braking results. (High speed series wound motors are particularly difficult to brake rapidly and consistently.)

When using induction-type motors, the additional braking torque generated by using a high resistance rotor over a low resistance rotor, or a reluctance synchronous over a nonsynchronous type, should be considered when fast braking is desirable. Also, the reluctance synchronous motor will provide some holding torque, a

criteria which might not be satisfied by any other motor type. The holding torque difference between a nonsynchronous induction motor and a synchronous reluctance induction motor may be as much as 10:1 with continuous DC applied.

There appears to be a definite advantage to using an AC induction motor over a

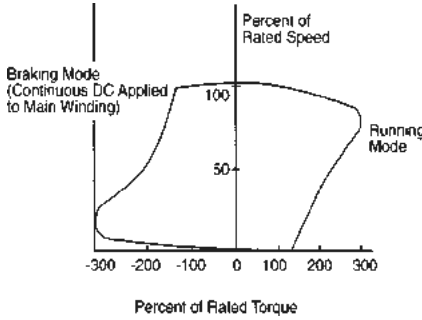

Fig. 10-28: PSC motor speed / torque curves.

DC shunt-wound motor which is traceable to the braking torque generated by each. Comparison of Fig. 10-28 with Fig. 10-29 will illustrate the basic differences between a PSC motor and a shunt-wound motor (both of the same hp rating).

In Fig. 10-28, the first (right-hand) quadrant represents the normal running characteristic curve. The second (left-hand) quadrant shows the normal braking characteristic. Since the AC motor has a high braking torque close to zero speed, it tends to be “snubbed down” to a stop quite nicely, whereas the DC motor (Fig. 10-29) will tend to lose its braking force as the speed is reduced and tends to coast more. The area under the curve divided by the operating speed represents the average braking torque.

In some cases, the split-phase motor (Fig. 10-30) may not brake as quickly as the PSC motor (compare Fig. 10-28 with Fig. 10-30) even though its generated braking torque is as high or higher than that of a permanent split capacitor motor.

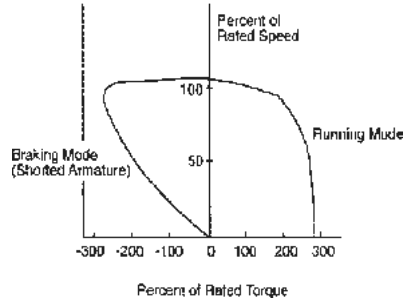

Fig. 10-29: Shunt motor speed / torque curves.

The reason appears to be the result of differences in rotor inertia.

As mentioned earlier, when using a split-phase motor, it is advisable to use a

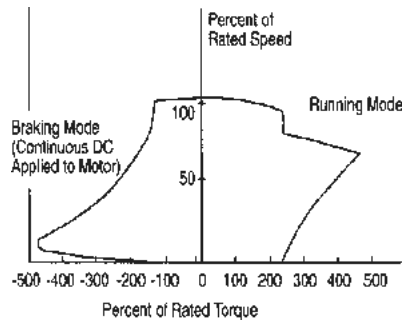

Fig. 10-30: Split-phase motor speed / torque curves.

starting capacitor in series with the starting switch and winding to limit the DC braking current and prevent overheating of the starting winding and destructive arcing at the starting switch contacts.

Although the series wound motor can be furnished in a smaller package than other motor types with the same horsepower, it does not brake as consistently as other motor types because of its higher operating speed (high kinetic energy) and limited braking power available by the normal regenerative method.

The capacitor discharge method, described earlier, is only effective on small subfractional induction motors driving low inertial loads, since a reasonably sized ca-

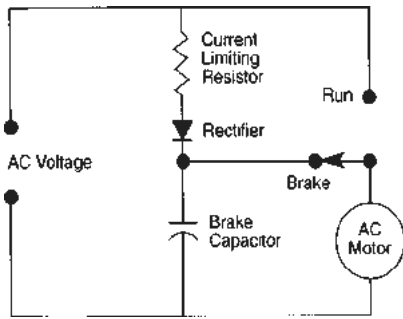

Fig. 10-31: Braking by half-wave with capacitor discharge.

capacitor has only a limited amount of stored energy to dynamically brake or counteract the kinetic energy of the motor and its load.

Frequently, a capacitor is used in conjunction with a diode to provide a “combination” half-wave and capacitor discharge braking circuit to eliminate the shortcomings of each. Used by itself, the capacitor has limited energy to release while the half-wave brake by itself may cause a PSC motor to rotate slowly after its speed has been brought down from its original level.

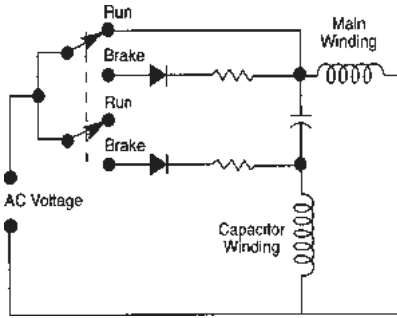

Fig. 10-32: Half-wave braking of a PSC motor.

Figure 10-31 is a typical capacitor/half-wave braking circuit that may be used in place of full wave or pure DC to provide dynamic braking almost equivalent to the latter. The slow rotational speed experienced with a PSC motor after the initial braking period with half-wave DC can often be eliminated by bypassing the motor capacitor in the braking mode as shown in Fig. 10-32.

Appendix 1

List of Associations and Standards Organizations

Most motor and control manufacturers design their products to conform to a variety of safety standards. For convenience, a partial list of these standards organizations and associations is given below. Specific standards are referenced throughout the *Handbook*. If the reader wishes to obtain more detailed information about a specific standard, the appropriate agency or association should be contacted directly.

American National Standards Institute (ANSI)

1430 Broadway
New York, NY 10018

American Society of Testing and Materials (ASTM)

1916 Race Street
Philadelphia, PA 19103

Canadian Standards Association (CSA)

179 Rexdale Boulevard
Rexdale, Ontario, Canada M9W 1R3

Electronic Industries Association (EIA)

2001 Pennsylvania Avenue, NW
Washington, DC 20006-1813

Institute of Electrical and Electronic Engineers (IEEE)

345 East 47th Street
New York, NY 10017

International Organization for Standardization (ISO)

1 Rue de Varembe
1211 Geneva 20, Switzerland

Mechanical Power Transmission Association

1717 Howard Street
Evanston, IL 60201

National Electrical Manufacturers Association (NEMA)

2101 L Street, NW
Washington, DC 20037

National Fire Protection Association (NFPA)

Batterymarch Park
Quincy, MA 02269

Underwriters Laboratories Inc. (UL)

333 Pfingsten Road
Northbrook, IL 60062

Appendix 2

Troubleshooting fhp Motors

IMPORTANT: Before servicing or working on equipment, always disconnect the power source. This applies to all equipment, but special attention should be given to thermally protected equipment using automatic restart devices, control equipment which is under the control of external logic circuits, or brush-type motors and gearmotors when the brushes are being examined or replaced. All of these situations present a higher potential for shock hazard or for injuries which might occur due to unanticipated mechanical motion.

Before attempting to service any motor, read the manufacturer's warranty information. In many cases, service by unauthorized persons will void the warranty. If an external examination cannot determine the cause of the problem, always consult the manufacturer before examining internal parts.

The motor environment should be cleaned regularly to prevent dirt and dust from interfering with ventilation or clogging moving parts. Refer to Chapter 7 for information on the care and servicing of motors and gearmotors. Refer to Chapter 5 for motor environmental protection information.

Before servicing motors or gearmotors employing capacitors, always discharge the capacitor by placing a conductor across its terminals before touching the terminals with any part of your body. Failure to discharge the capacitor could result in electrical shock.

In many cases, easy-to-detect symptoms will indicate exactly what is wrong with a fractional horsepower motor. However, since general types of motor trouble have similar symptoms, it is necessary to check each possible cause separately. The accompanying table (on page A-3) lists some of the more common ailments of small motors and the likely causes.

Most common motor troubles can be checked by a series of inspections or basic measurements. The order in which these tests are performed are a matter of preference, but it is advisable to perform the easiest first.

In diagnosing troubles, a combination of symptoms will often point to a specific source of trouble. For example, if a motor will not start and yet heating occurs, there is a good likelihood that a short or ground exists in one of the windings.

In the case of brushless motors, a symptom exhibited in the motor may actually be caused by a problem in the control. External motion control circuitry often associated with motor control systems can also be a source of problems. It is always wise to check the connections between system components first before attempting to isolate internal motor or control problems.

Centrifugal starting switches are occasionally the source of fhp motor problems. These switches have a finite life and can wear in many ways depending on their design and use. Open switches will prevent a motor from starting. When stuck in the closed position, the motor will operate at slightly reduced speed and the start winding will overheat quickly. Other problems can be caused by oxidized or out of alignment contact points on the switch. It is important to remember that any adjustment of the switch or contacts should be made by the manufacturer or an authorized service representative.

Because of the wear effects of brushes and commutators, commutated motors require more maintenance than nonbrush types. The wear rate of brushes is dependent upon many parameters (armature speed, current, duty cycle, humidity, etc.). For optimum performance, brush-type motors and gearmotors need periodic user-maintenance. Refer to Chapter 5 for information on maintaining brushes.

Reference Guide to Probable Causes of Motor Problems

Motor Type	AC SINGLE-PHASE					Brush-Type (Universal Series, PM, Shunt Compound)
	Split-Phase	Capacitor Start	Permanent Split Capacitor	Shaded Pole	AC Polyphase (2 or 3-Phase)	
PROBLEM	PROBABLE CAUSES					
Will not start.	1, 2, 3, 5, 7, 8, 9, 16, 17, 20, 21	1, 2, 3, 4, 5, 7, 8, 9, 16, 17, 20, 21	1, 2, 4, 5, 7, 8, 9, 16, 17, 20, 21	1, 2, 7, 8, 16, 17, 20, 21	1, 2, 7, 8, 9, 16, 17, 20, 21	1, 2, 7, 8, 12, 13, 16, 17, 19, 20, 21
Will not always start, even with no load, but will run in either direction when started manually.	3, 5, 20	3, 4, 5, 20	4, 5, 9, 20	—	9	—
Starts, but heats rapidly.	6, 7, 8, 16, 17, 20	6, 7, 8, 16, 17, 20	4, 7, 8, 16, 17, 20	7, 8, 16, 17, 20	7, 8, 16, 17, 20	7, 8, 16, 17, 19, 20
Runs too hot after extended operation.	7, 16, 18, 21, 22, 28	7, 16, 18, 21, 22, 28	7, 16, 18, 21, 22, 28	7, 16, 18, 21, 22, 28	7, 16, 18, 21, 22, 28	7, 16, 18, 21, 22, 28
Excessive noise (mechanical).	17, 22, 23, 24, 25	17, 22, 23, 24, 25	17, 22, 23, 24, 25	17, 22, 23, 24, 25	17, 22, 23, 24, 25	10, 17, 22, 23, 24, 25
Sluggish—sparks severely at the brushes.	—	—	—	—	—	10, 11, 12, 13, 14, 19
High no-load speed.	—	—	—	—	—	15
Reduction in power—motor gets too hot.	8, 16, 17, 20, 21	8, 16, 17, 20, 21	4, 8, 16, 17, 20, 21	8, 16, 17, 20, 21	8, 9, 16, 17, 20, 21	13, 16, 17, 19, 20, 21
Excessive brush wear.	—	—	—	—	—	10, 11, 13, 19, 23, 26, 27
Jerky operation—severe vibration.	—	—	—	—	—	10, 11, 12, 13, 19

*NOTE: Caution must be exercised since motor winding may be grounded or sudden start-up of motor may cause injury.

List of Probable Causes:

1. Open circuit in connection to line (blown fuses, overload protector tripped or faulty).
2. Open circuit in motor winding.
3. Defective starting switch.
4. Defective capacitor.
5. Starting (or auxiliary) winding open.
6. Starting switch not opening.
7. Overloaded motor (mechanical failure in load).
8. Winding shorted or grounded.
9. One or more windings open.
10. High mica between commutator bars or rough commutator.

11. Dirty or out of round commutator.

12. Worn or sticking brushes and/or annealed brush springs.

13. Open circuit or short circuit in armature winding.

14. Oil-soaked brushes.

15. Open shunt field or demagnetized magnets (PM).

16. Tight or seized bearings.

17. Interference between stationary and rotating member.

18. Failure of ventilation (blocked or obstructed ventilation openings).

19. Shorted or grounded armature winding.

20. Wrong connection of motor.

21. Improper or low line voltage (not within $\pm 10\%$ of nameplate rating).

22. Worn bearings.

23. Unbalanced rotor or armature (vibration).

24. Poor alignment between motor and load.

25. Amplified motor noises due to mounting conditions.

26. Incorrect spring tension.

27. Lack of moisture.

28. High ambient temperature.

Appendix 3

Helpful Shortcuts

Resistor Value Codes

The color code adopted by the Electronic Industries Association is used to standardize the markings on resistors so that their resistance value can be determined. The color band system is the most common marking method.

The first color represents the first significant digit of the resistor value. The second color represents the second significant digit. The third color corresponds to a power of ten multiplier. Quite simply, it represents how many zeros to add after the significant digits. A fourth color is used to indicate the tolerance of the resistor. The body-end dot and body-end band systems are also used.

Resistor Color Codes			
Color	Digit	Multiplier	Tolerance
Black	0	1	±20%
Brown	1	10	±1%
Red	2	100	±2%
Orange	3	1000	±3%
Yellow	4	10000	Guaranteed Minimum Value (-0/+100%)
Green	5	100000	±5%
Blue	6	1000000	±6%
Violet	7	10000000	±121/2%
Gray	8	0.01	±30%
White	9	0.1	±10%
Gold	—	0.1	±5%
Silver	—	0.01	±10%
No Color	—	—	±20%

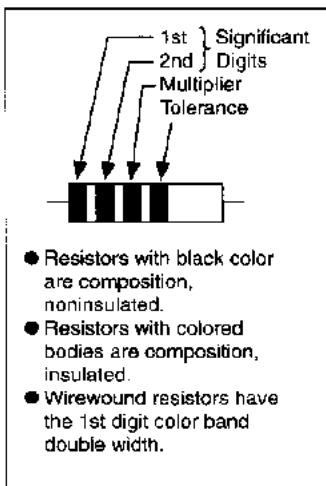

Band System

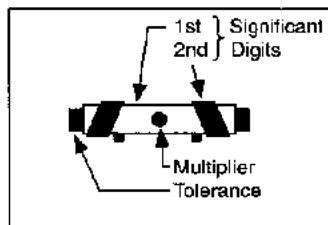

Body-End-Dot System

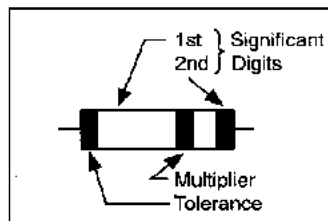

Body-End-Band System

Left-Hand Rule for Electromagnetism

This rule is helpful in remembering the principle of electromagnetism used in electric motors and for determining the direction of current flow in relation to magnetic field and conductor motion. Bend your left hand in the shape shown in Figure A3-1. The thumb points in the direction of force on a conductor. The first finger points in the direction of the magnetic field, north to south. The second finger points in the direction of current flow.

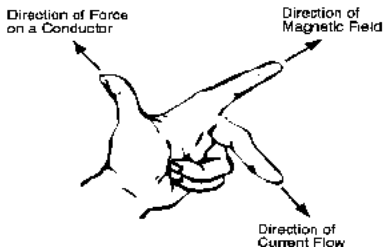

Fig. A3-1: Left-hand rule for electro-magnetism

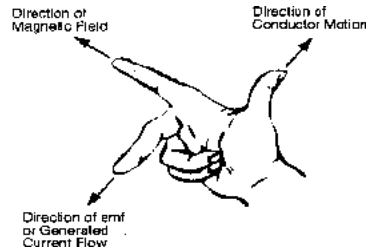

Fig. A3-2: Right-hand rule for induction.

Right-Hand Rule for Induction

This rule helps you to remember the relationship between current flow and magnetic fields in a generator. See Fig. A3-2. The thumb points in the direction of conductor motion. The first finger points in the direction of the magnetic field and the second points in the direction of the emf or generated current flow.

Determine surface speed in feet per minute (sfm) for a given spindle speed and work (or tool) diameter by multiplying $\frac{1}{4}$ of the speed by the work or tool diameter. For example: For a lathe running 400 rpm and a 3" work diameter, what is the sfm? Answer: $\frac{1}{4}$ of 400 rpm = 100. $100 \times 3" = 300$ sfm.

When you want to select a speed to give a desired surface speed, divide desired sfm by work or tool diameter and multiply by 4. For example: You want 300 sfm for a 3" work diameter. To find machine speed: $300 \div 3" = 100$. $100 \times 4 = 400$ rpm.

The correct wrench size for nuts and bolts doesn't have to be found by trial and error. To pick up just the tool you need, you merely have to remember that the right wrench is almost always 1st times the nominal thread size of the bolt or nut. For example: A 1st" bolt takes a 1st" wrench (" x 1" = 1").

Equivalent hardness. In the most commonly used portions of scales, Brinell hardness numbers equal approximately 1/10th of the equivalent hardness indicated on the Rockwell "C" Hardness Scale. Multiply Rockwell "C" numbers by 10 to get the approximate Brinell equivalent. For example: $50 \text{ RC} \times 10 = \text{about } 500 \text{ Br}$. $350 \text{ Br} \div 10 = \text{about } 35 \text{ RC}$.

Find spur-gear DP (diametral pitch) by measuring the number of times two pitches will fit in 3" on a scale, and halve it to produce the pitch. Measure halfway between the teeth at about the middle of the tooth depth. Disregard small departures to arrive at an even answer. (Standard pitches in the size normally encountered are whole numbers from about 4 diametral pitch through 40 DP.)

Determine exact pitch diameter of any standard spur gear without so much as touching the gear in question. Simply count the teeth and divide by the diametral pitch.

Appendix 4

Motor Application Formulae

T = torque or twisting moment (force x moment arm length)

$\pi = 3.1416$

N = revolutions per minute

hp = horsepower (33,000 ft-lbs. per minute); applies to power output

J = moment of inertia

E = input voltage

I = current in amperes

P = power input in watts

$$\text{hp} = \frac{T(\text{lb-in.}) \times N}{63,025}$$

$$\text{hp} = T(\text{oz-in.}) \times N \times 9.917 \times 10^{-7} = \text{approximately } T(\text{oz-in.}) \times N \times 10^{-6} \div \text{hp} \times 746$$

$$P = EI \times \text{power factor} = \frac{\quad}{\text{motor efficiency}}$$

Power to Drive Pumps:

$$\text{hp} = \frac{\text{gallons per minute} \times \text{total head (including friction)}}{3,960 \times \text{efficiency of pump}}$$

where:

$$\text{approximate friction head (feet)} = \frac{\text{pipe length (feet)} \times [\text{velocity of flow (fps)}]^2 \times 0.02}{5.367 \times \text{diameter (inches)}}$$

Efficiency = approximately 0.50 to 0.85

Time to Change speed of Rotating Mass:

$$\text{Time (seconds)} = \frac{J \times \text{change in rpm}}{308 \times \text{torque (ft-lb.)}}$$

where:

$$J(\text{disc}) = \frac{\text{weight (lbs.)} \times [\text{radius(feet)}]^2}{2}$$

$$J(\text{rim}) = \frac{\text{weight (lbs.)} \times [\text{outer radius(feet)}]^2 + (\text{inner radius in feet})^2}{2}$$

Power to Drive Fans:

$$\text{hp} = \frac{\text{cubic feet air per minute} \times \text{water gauge pressure (inches)}}{6,350 \times \text{efficiency}}$$

Ohm's Law:

$$\text{amperes} = \frac{\text{volts}}{\text{ohms}}$$

Power in DC Circuits:

$$\text{Watts} = \text{volts} \times \text{amperes}$$

$$\text{Horsepower} = \frac{\text{volts} \times \text{amperes}}{746}$$

$$\text{Kilowatts} = \frac{\text{volts} \times \text{amperes}}{1000}$$

$$\text{Kilowatts hours} = \frac{\text{volts} \times \text{amperes} \times \text{hours}}{1000}$$

Power in AC Circuits:

$$\text{Apparent power: kilovolt-amperes (KVA)} = \frac{\text{volts} \times \text{amperes}}{1000}$$

$$\text{Power factor} = \frac{\text{kilowatts}}{\text{kilovolt-amperes}}$$

$$\text{Single-phase kilowatts (Kw)} = \frac{\text{volts} \times \text{amperes} \times \text{power factor}}{1000}$$

$$\text{Two-phase Kw} = \frac{\text{volts} \times \text{amperes} \times \text{power factor} \times 1.4142}{1000}$$

$$\text{Three-phase Kw} = \frac{\text{volts} \times \text{amperes} \times \text{power factor} \times 1.7321}{1000}$$

Geometric Formulae:

$$\pi = 3.1416$$

D = diameter

$$\text{Area of circle} = \frac{\pi D^2}{4}$$

$$\text{Area of sphere} = \pi D^2$$

$$\text{Volume of sphere} = \frac{\pi D^3}{6}$$

$$\text{Area of triangle} = \frac{1}{2} \text{ altitude} \times \text{base}$$

Appendix 5

PROPERTIES OF MATERIALS

Liquid	Pounds Per Gallon	Element	Symbol	Melting Point °F	Coefficient of Expansion per °F	Electrical Conductivity % Pure Copper	Pounds per Cubic Inch
Acetone	6.6	Aluminum	Al	1215	.0000133	64.90	.098
Alcohol (100%)	6.8	Antimony	Sb	1167	.00000627	4.42	.239
Ammonia	7.4	Beryllium	Be	2345	.0000068	9.32	.066
Benzene	6.4	Bismuth	Bi	520	.00000747	1.50	.354
Benzol	7.4	Cadmium	Cd	610	.00000166	22.70	.313
Carbon Tetrachloride	13.3	Chromium	Cr	2822	.0000045	13.20	.258
Castor Oil	8.1	Cobalt	Co	2714	.00000671	17.80	.322
Gasoline	6.1	Copper	Cu	1981	.0000091	100.00	.323
Glue Liquid	10.7	Gold	Au	1945	.0000080	71.20	.697
Hydrochloric Acid	9.4	Iron	Fe	2795	.0000066	17.60	.284
Kerosene	6.7	Lead	Pb	621	.0000164	8.35	.409
Lard Oil	7.7	Magnesium	Mg	1204	.0000143	38.70	.063
Linseed Oil	7.8	Mercury	Hg	-38	—	1.80	.489
Machine Oil	7.5	Molybdenum	Mo	4748	.00000305	36.10	.368
Paints	10.3-13.5	Nickel	Ni	2646	.0000076	25.00	.322
Shellac	7.5	Platinum	Pt	3224	.0000043	17.50	.774
Sodium Silicate	12.0	Selenium	Se	428	.0000206	14.40	.174
Sulphuric Acid	15.3	Silver	Ag	1761	.0000105	106.00	.380
Tung Oil	7.8	Tellurium	Te	846	.0000093	—	.224
Turpentine	7.3	Tin	Sn	450	.0000124	15.00	.264
Varnish-Insulation	7.0	Tungsten	W	6098	.0000022	31.50	.698
Water	8.34	Vanadium	V	3110	—	6.63	.205
		Zinc	Zn	787	.0000219	29.10	.258

Appendix 6

Temperature Conversions

$$^{\circ}\text{C} \quad \blacklozenge \quad ^{\circ}\text{F}$$

$$\Re$$

The numbers in italics in the center column refer to the temperature, either in Celsius or Fahrenheit, which is to be converted to the other scale. If converting Fahrenheit to Celsius, the equivalent temperature will be found in the left column. If converting Celsius to Fahrenheit, the equivalent temperature will be found in the column on the right.

-100 to 30			31 to 71			72 to 212			213 to 620			621 to 1000		
C	F		C	F		C	F		C	F		C	F	
-73	<i>-100</i>	-148	-0.6	<i>31</i>	87.8	22.2	<i>72</i>	161.6	104	<i>220</i>	428	332	<i>630</i>	1166
-68	<i>-90</i>	-130	0	<i>32</i>	89.6	22.8	<i>73</i>	163.4	110	<i>230</i>	446	338	<i>640</i>	1184
-62	<i>-80</i>	-112	0.6	<i>33</i>	91.4	23.3	<i>74</i>	165.2	116	<i>240</i>	464	343	<i>650</i>	1202
-57	<i>-70</i>	-94	1.1	<i>34</i>	93.2	23.9	<i>75</i>	167.0	121	<i>250</i>	482	349	<i>660</i>	1220
-51	<i>-60</i>	-76	1.7	<i>35</i>	95.0	24.4	<i>76</i>	168.8	127	<i>260</i>	500	354	<i>670</i>	1238
-46	<i>-50</i>	-58	2.2	<i>36</i>	96.8	25.0	<i>77</i>	170.6	132	<i>270</i>	518	360	<i>680</i>	1256
-40	<i>-40</i>	40	2.8	<i>37</i>	98.6	25.6	<i>78</i>	172.4	138	<i>280</i>	536	366	<i>690</i>	1274
-34.4	<i>-30</i>	22	3.3	<i>38</i>	100.4	26.1	<i>79</i>	174.2	143	<i>290</i>	554	371	<i>700</i>	1292
-28.9	<i>-20</i>	-4	3.9	<i>39</i>	102.2	26.7	<i>80</i>	176.0	149	<i>300</i>	572	377	<i>710</i>	1310
-17.8	<i>-10</i>	14	4.4	<i>40</i>	104.0	27.2	<i>81</i>	177.8	154	<i>310</i>	590	382	<i>720</i>	1328
-17.2	0	32	5.0	<i>41</i>	105.8	27.8	<i>82</i>	179.6	160	<i>320</i>	608	388	<i>730</i>	1346
-17.2	<i>1</i>	33.8	5.6	<i>42</i>	107.6	28.3	<i>83</i>	181.4	166	<i>330</i>	626	393	<i>740</i>	1364
-16.7	<i>2</i>	35.6	6.1	<i>43</i>	109.4	28.9	<i>84</i>	183.2	171	<i>340</i>	644	399	<i>750</i>	1382
-16.1	<i>3</i>	37.4	6.7	<i>44</i>	111.2	29.4	<i>85</i>	185.0	177	<i>350</i>	662	404	<i>760</i>	1400
-15.6	<i>4</i>	39.2	7.2	<i>45</i>	113.0	30.0	<i>86</i>	186.8	182	<i>360</i>	680	410	<i>770</i>	1418
-15.0	<i>5</i>	41.0	7.8	<i>46</i>	114.8	30.6	<i>87</i>	188.6	188	<i>370</i>	698	416	<i>780</i>	1436
-14.4	<i>6</i>	42.8	8.3	<i>47</i>	116.6	31.1	<i>88</i>	190.4	193	<i>380</i>	716	421	<i>790</i>	1454
-13.9	<i>7</i>	44.6	8.9	<i>48</i>	118.4	31.7	<i>89</i>	192.2	199	<i>390</i>	734	427	<i>800</i>	1472
-13.3	<i>8</i>	46.4	9.4	<i>49</i>	120.0	32.2	<i>90</i>	194.0	204	<i>400</i>	752	432	<i>810</i>	1490
-12.8	<i>9</i>	48.2	10.0	<i>50</i>	122.0	32.8	<i>91</i>	195.8	210	<i>410</i>	770	438	<i>820</i>	1508
-12.2	<i>10</i>	50.0	10.6	<i>51</i>	123.8	33.3	<i>92</i>	197.6	216	<i>420</i>	788	443	<i>830</i>	1526
-11.7	<i>11</i>	51.8	11.1	<i>52</i>	123.8	33.9	<i>93</i>	199.4	221	<i>430</i>	806	449	<i>840</i>	1544
-11.1	<i>12</i>	53.6	11.7	<i>53</i>	127.4	34.4	<i>94</i>	201.2	227	<i>440</i>	824	454	<i>850</i>	1562
-10.6	<i>13</i>	55.4	12.2	<i>54</i>	129.2	35.0	<i>95</i>	203.0	232	<i>450</i>	842	460	<i>860</i>	1580
-10.0	<i>14</i>	57.4	12.8	<i>55</i>	131.0	35.6	<i>96</i>	204.8	238	<i>460</i>	860	466	<i>870</i>	1592
-9.4	<i>15</i>	59.0	13.3	<i>56</i>	132.8	36.1	<i>97</i>	206.6	243	<i>470</i>	878	471	<i>880</i>	1616
-8.9	<i>16</i>	60.8	13.9	<i>57</i>	134.6	36.7	<i>98</i>	208.4	249	<i>480</i>	896	477	<i>890</i>	1634
-8.3	<i>17</i>	62.6	14.4	<i>58</i>	136.4	37.2	<i>99</i>	210.2	254	<i>490</i>	914	482	<i>900</i>	1652
-7.8	<i>18</i>	64.4	15.0	<i>59</i>	138.2	37.8	<i>100</i>	212.0	260	<i>500</i>	932	488	<i>910</i>	1670
-7.2	<i>19</i>	66.2	15.6	<i>60</i>	140.0	43	<i>110</i>	230	266	<i>510</i>	950	493	<i>920</i>	1688
-6.7	<i>20</i>	68.0	16.1	<i>61</i>	141.8	49	<i>120</i>	248	271	<i>520</i>	968	499	<i>930</i>	1706
-6.1	<i>21</i>	69.8	16.7	<i>62</i>	143.6	54	<i>130</i>	266	277	<i>530</i>	986	504	<i>940</i>	1724
-5.6	<i>22</i>	71.6	17.2	<i>63</i>	145.4	60	<i>140</i>	284	282	<i>540</i>	1004	510	<i>950</i>	1742
-5.0	<i>23</i>	73.4	17.8	<i>64</i>	147.2	66	<i>150</i>	302	288	<i>550</i>	1022	516	<i>960</i>	1760
-4.4	<i>24</i>	75.2	18.3	<i>65</i>	149.0	71	<i>160</i>	320	293	<i>560</i>	1040	521	<i>970</i>	1778
-3.9	<i>25</i>	77.0	18.9	<i>66</i>	150.8	77	<i>170</i>	338	299	<i>570</i>	1058	527	<i>980</i>	1796
-3.3	<i>26</i>	78.8	19.4	<i>67</i>	152.6	82	<i>180</i>	356	304	<i>580</i>	1076	532	<i>990</i>	1814
-2.8	<i>27</i>	80.6	20.0	<i>68</i>	154.4	88	<i>190</i>	374	310	<i>590</i>	1094	538	<i>1000</i>	1832
-2.2	<i>28</i>	82.4	20.6	<i>69</i>	156.2	93	<i>200</i>	392	316	<i>600</i>	1112			
-1.7	<i>29</i>	84.2	21.1	<i>70</i>	158.0	99	<i>210</i>	410	321	<i>610</i>	1130			
-1.1	<i>30</i>	86.0	21.7	<i>71</i>	159.8	100	<i>212</i>	414	327	<i>620</i>	1148			

Appendix 7

SI (Metric) Conversion Table

	SI Unit	Imperial/Metric to SI	SI to Imperial/Metric
Length	meter (m)	1 inch = 2.54×10^{-2} m 1 foot = 0.305 m 1 yard = .914 m	1 m = 39.37 inches = 3.281 feet = 1.094 yards
Mass	kilogram (kg.)	1 ounce (mass) = 28.35×10^{-3} kg. 1 pound (mass) = 0.454 kg. 1 slug = 14.59 kg.	1 kg = 35.27 ounces = 2.205 pounds = 168.521×10^{-3} slug
Area	square meter (m ²)	1 sq. in. = 6.45×10^{-4} m ² 1 sq. ft. = 0.93×10^{-1} m ² 1 sq. yd. = 0.836 m ²	1 m ² = 1550 square inch = 10.76 square feet = 1.196 square yard
Volume	cubic meter (m ³)	1 cu. in. = 16.3×10^{-6} m ³ 1 cu. ft. = 0.028 m ³	1 m ³ = 6.102×10^4 cubic inch = 35.3 cubic feet
Time	second (s)	same as Imperial/Metric	same as Imperial/Metric
Electric Current	ampere (A)	same as Imperial/Metric	same as Imperial/Metric
Plane Angle	radian (rad.)	1 angular deg. = 1.745×10^2 rad. 1 revolution = 6.283 radians	1 radian = 57.296 angular degrees
Frequency	hertz (Hz)	1 cycle/sec. = 1 Hz	1 Hz = 1 cycle / second
Force (f)	newton (N)	1 oz. (f) = 0.278 N 1 lb. (f) = 4.448 N 1 kilopond = 9.807 N 1 kgf = 9.907 N	1 N = 3.597 oz. (f) = 0.225 lb. (f) = 0.102 kp = 0.102 kgf
Energy (Work)	joule (J)	1 btu = 1055.06 J 1 kwh = 3.6×10^{-6} J 1 watt / sec. = 1 J 1 kcal = 4186.8 J	1 J = 9.478×10^{-4} Btu = 2.778×10^{-7} kwh = 1 Ws = 2.389×10^{-4} kcal
Power	watt (W)	1 hp = 746 W	1 W = 1.341×10^{-3} hp
Qty. of Electricity	coulomb (C)	same as Imperial/Metric	same as Imperial/Metric
emf	volt (V)	same as Imperial/Metric	same as Imperial/Metric
Resistance	ohm(Ω)	same as Imperial/Metric	same as Imperial/Metric
Capacitance	farad (F)	same as Imperial/Metric	same as Imperial/Metric
Inductance	henry (H)	same as Imperial/Metric	same as Imperial/Metric
Magnetic Flux	weber (Wb)	1 line = 10^8 Wb 1 Mx = 10^{-8} Wb 1 Vs = 1 Wb	1 Wb = 10^8 lines = 10^8 lines = 1 Vs
Magnetic Flux Density	tesla (T)	1 line / in ² = 1.55×10^{-5} T 1 gauss = 10^{-4} T	1 T = 6.452×10^4 lines / in ² = 10^4 gauss
Linear Velocity	meter / second (m / s)	1 inch / sec. = 2.54×10^{-2} m / s 1 mph = 1.609 km / s	1 m / s = 39.37 inches / second = 3.281 feet / second
Linear Acceleration	meter / second ² (m / s ²)	1 inch/second ² = 2.54×10^{-4} m/s ²	1 m / s ² = 39.37 inch / second ² = 3.281 feet / second ²
Torque	newtonmeter (N ^o m)	1 lb.-ft. = 1.356 N ^o m 1 oz.-in. = 7.062×10^{-3} N ^o m 1 kilopondmeter = 9.807 N ^o m 1 lb.-in. = 0.113 N ^o m	1 N ^o m = 0.738 lb.-ft. = 8.851 lb.-in. = 0.102 kpm = 141.61 oz. in .
Temperature	degree Celsius (°C)	°F = (°C x 9/5) + 32	°C = (°F-32) x 5/9

Appendix 8 Typical Gearmotor Construction

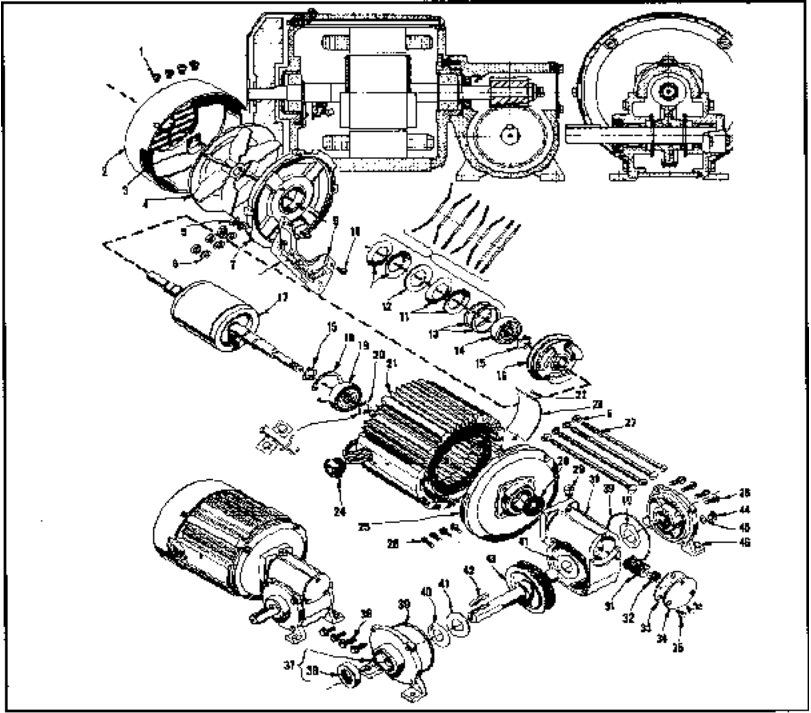

- | | |
|--|---|
| <ol style="list-style-type: none"> 1. Screw, Shroud (.164-32 X .25 thread forming) 2. Shroud 3. Ring, Fan Retaining 4. Fan 5. Nut, Case Holding Screw (.190-32 X .12 thread hex) 6. Gasket, Aluminum 7. Shield, Front 8. Insulator, Actuator Starting Switch (when required) 9. Switch, Actuator Starting (when required) 10. Screw, Actuator Starting Switch (when required) 11. Washer, Belleville 12. Washer, Steel Spacing (.81 I.D.) 13. Washer, Steel Spacing (1.12 I.D.) 14. Bearing, Ball 15. Ring, Retaining (external) 16. Actuator (when required) 17. Rotor 18. Ring, Retaining (internal) 19. Bearing, Ball 20. Ring, Retaining (bowed, external) 21. Ring and Stator (wound complete) 22. Pin, Nameplate 23. Nameplate 24. Bushing, Threaded 25. Shield, Rear | <ol style="list-style-type: none"> 26. Screw, Gear Housing Holding (.190-32 X .44 thread forming) 27. Screw, Case Holding (48R4-5N) (.190-32 X 4.88) 27. Screw, Case Holding (48R5-5N) (.190-32 X 5.44) 27. Screw, Case Holding (48R6-5N) (.190-32 X 5.91) 28. Seal, Rotor 29. Plug, Breather Hole 30. Housing, Gear 31. Worm 32. Nut, Worm Lock 33. Gasket, Gear Housing End Cap 34. Cap, Gear Housing End 35. Screw, Gear Housing End Cap (.164-32 X .38 thread forming) 36. Screw, Gear Housing End Shield (.190-32 X .56 thread forming) 37. End Shield, Gear Housing (extension end) 38. Seal, Driveshaft 39. "O" Ring 40. Washer, Thrust (nylon) 41. Washer, Thrust (steel) 42. Key 43. Gear and Driveshaft 44. Screw, Oil Level 45. Gasket, Oil Level Screw 46. End Shield, Gear Housing (nonextension end) |
|--|---|

Appendix 9

Horsepower/Watts vs. Torque Conversion Chart

Power		at 1125 rpm		at 1200 rpm		at 1425 rpm	
hp	watts	oz-in.	mN ° m	oz-in.	mN ° m	oz-in.	mN ° m
1/2000	.373	.4482	3.1648	.4202	2.9670	.3538	2.4986
1/5000	.497	.5976	4.2198	.5602	3.9560	.4718	3.3314
1/1000	.746	.8964	6.3297	.8403	5.9341	.7077	4.9971
1/750	.995	1.1951	8.4396	1.1204	7.9121	.9435	6.6628
1/500	1.49	1.7927	12.6593	1.6807	11.8681	1.4153	9.9942
1/200	3.73	4.4818	31.6483	4.2017	29.6703	3.5383	24.9855
1/150	4.97	5.9757	42.1978	5.6022	39.5604	4.7177	33.3140
1/100	7.46	8.9636	63.2966	8.4033	59.3406	7.0765	49.9710
1/75	9.95	11.9514	84.3955	11.2044	79.1208	9.4353	66.6280
1/70	10.7	12.8051	90.4238	12.0048	84.7723	10.1093	71.3872
1/60	12.4	14.9393	105.4944	14.0056	98.9010	11.7942	83.2850
1/50	14.9	17.9271	126.5933	16.8067	118.6812	14.1530	99.9420
1/40	18.7	22.4089	158.2416	21.0083	148.3515	17.6912	124.9276
1/30	24.9	29.8785	210.9887	28.0111	197.8020	23.5883	166.5701
1/25	29.8	35.8542	253.1865	33.6133	237.3623	28.3060	199.8841
1/20	37.3	44.8178	316.4831	42.0167	296.7029	35.3825	249.8551
1/15	49.7	59.7570	421.9775	56.0222	395.6039	47.1766	333.1401
1/12	62.2	74.6963	527.4719	70.0278	494.5047	58.9709	416.4252
1/10	74.6	89.6356	632.9662	84.0333	593.4058	70.7649	499.7102
1/8	93.3	112.0444	791.2078	105.0417	741.7572	88.4561	624.6377
1/6	124.3	149.3926	1054.9437	140.0556	989.0096	117.9415	832.8503
1/4	186.1	224.0889	1582.4156	210.0833	1483.5146	176.9123	1249.2755
1/3	248.7	298.7852	2109.8874	280.1111	1978.0195	235.8830	1665.7006
1/2	373.0	448.1778	3164.8312	420.1667	2967.0292	353.8246	2498.5509

Power		at 3600 rpm		at 5000 rpm		at 7500 rpm	
hp	watts	oz-in.	mN ° m	oz-in.	mN ° m	oz-in.	mN ° m
1/2000	.373	.3361	2.3736	.2923	2.0640	.2801	1.9780
1/5000	.497	.4482	3.1648	.3897	2.7520	.3735	2.6374
1/1000	.746	.6723	4.7473	.5846	4.1280	.5602	3.9560
1/750	.995	.8964	6.3297	.7794	5.5041	.7470	5.2747
1/500	1.49	1.3445	9.4945	1.1692	8.2561	1.1204	7.9121
1/200	3.73	3.6613	23.7362	2.9229	20.6402	2.8011	19.7802
1/150	4.97	4.4818	31.6483	3.8972	27.5203	3.7348	26.3736
1/100	7.46	6.7227	47.4725	5.8458	41.2804	5.6022	39.5604
1/75	9.95	8.9636	63.2966	7.7944	55.0405	7.4696	52.7472
1/70	10.7	9.6038	67.8178	8.3511	58.9720	8.0032	56.5148
1/60	12.4	11.2044	79.1208	9.7430	68.8007	9.3370	65.9340
1/50	14.9	13.4453	94.9449	11.6916	82.5608	11.2044	79.1208
1/40	18.7	16.8067	118.6812	14.6145	103.2010	14.0056	98.9010
1/30	24.9	22.4089	158.2416	19.4860	137.6014	18.6741	131.8680
1/25	29.8	26.8907	189.8899	23.3832	165.1216	22.4089	158.2416
1/20	37.3	33.6133	237.3623	29.2290	206.4020	28.0111	197.8020
1/15	49.7	44.8178	316.4831	38.9720	275.2027	37.3482	263.7359
1/12	62.2	56.0222	395.6040	48.7150	344.0034	46.6852	329.6699
1/10	74.6	67.2267	474.7247	58.4580	412.8041	56.0222	395.6039
1/8	93.3	84.0333	593.4058	73.0725	516.0051	70.0278	494.5049
1/6	124.0	112.0444	791.2078	97.4300	688.0068	93.3704	659.3398
1/4	186.5	168.0667	1186.8117	146.1449	1032.0104	140.0556	989.0097
1/3	249.0	224.0889	1582.4156	194.8599	1376.0136	186.7407	1318.6797
1/2	373.0	336.1333	2373.6234	292.2899	2064.0203	280.1111	1978.0195

Power		at 3600 rpm		at 5000 rpm		at 7500 rpm	
hp	watts	oz-in.	mN ° m	oz-in.	mN ° m	oz-in.	mN ° m
1/2000	.373	.2017	1.4242	.1687	1.1868	.1461	1.0320
1/1500	.497	.2689	1.8989	.2241	1.5824	.1949	1.3760
1/1000	.746	.4034	2.8484	.3361	2.3736	.2923	2.0640
1/750	.995	.5378	3.7978	.4482	3.1648	.3897	2.7520
1/500	1.49	.8067	5.6967	.6723	4.7475	.5846	4.1280
1/200	3.73	2.0168	14.2417	1.6807	11.8681	1.4615	10.3201
1/150	4.97	2.6891	18.9890	2.2409	15.8242	1.9486	13.7601
1/100	7.46	4.0336	28.4835	3.3613	23.7362	2.9229	20.6402
1/75	9.95	5.3781	37.9780	4.4818	31.6483	3.8972	27.5203
1/70	10.7	5.7623	40.6907	4.8019	33.9089	4.1756	29.4860
1/60	12.4	6.7227	47.4725	5.6022	39.5604	4.8715	34.4003
1/50	14.9	8.0672	56.9670	6.7227	47.4725	5.8458	41.2804
1/40	18.7	10.0840	71.2087	8.4033	59.3406	7.3073	51.6005
1/30	24.9	13.4453	94.9449	11.2044	79.1208	9.7430	68.8007
1/25	29.8	16.1344	113.9339	13.4453	94.9449	11.6916	82.5608
1/20	37.3	20.1680	142.4174	16.8067	118.6812	14.6145	103.2010
1/15	49.7	26.8907	189.8899	22.4089	158.2416	19.4860	137.6014
1/12	62.2	33.6133	237.3623	28.0111	197.8020	24.3575	172.0017
1/10	74.6	40.3360	284.8348	33.6133	237.3623	29.2290	206.4020
1/8	93.3	50.4200	356.0435	42.0167	296.7029	36.5392	258.0025
1/6	124.0	67.2267	474.7247	56.0222	395.6039	48.7150	344.0034
1/4	186.1	100.8400	712.0870	84.0333	593.4058	73.0725	516.0051
1/3	249.0	134.4533	949.4494	112.0444	791.2078	97.4300	688.0068
1/2	373.0	201.6800	1424.1740	168.0667	1186.8117	146.1449	1032.0102

Power		at 3600 rpm		at 5000 rpm		at 7500 rpm	
hp	watts	oz-in.	mN ° m	oz-in.	mN ° m	oz-in.	mN ° m
1/2000	.373	.1401	.9890	.1008	.7121	.0672	.4747
1/5000	.497	.1867	1.3187	.1345	.9495	.0896	.6330
1/1000	.746	.2801	1.9780	.2017	1.4242	.1345	.9495
1/750	.995	.3735	2.6374	.2689	1.8989	.1793	1.2659
1/500	1.49	.5602	3.9560	.4034	2.8484	.2689	1.8989
1/200	3.73	1.4006	9.8901	1.0084	7.1209	.6723	4.7473
1/150	4.97	1.8674	13.1868	1.3445	9.4945	.8964	6.3297
1/100	7.46	2.8011	19.7802	2.0168	14.2417	1.3445	9.4945
1/75	9.95	3.7348	26.3736	2.6891	18.9890	1.7927	12.6593
1/70	10.7	4.0016	28.2574	2.8811	20.3453	1.9208	13.5636
1/60	12.4	4.6685	32.9670	3.3613	23.7362	2.2409	15.8242
1/50	14.9	5.6022	39.5604	4.0336	28.4835	2.6891	18.9890
1/40	18.7	7.0028	49.4505	5.0420	35.6044	3.3613	23.7362
1/30	24.9	9.3370	65.9340	6.7227	47.4725	4.4818	31.6483
1/25	29.8	11.2044	79.1208	8.0672	56.9670	5.3781	37.9780
1/20	37.3	14.0056	98.9010	10.0840	71.2087	6.7227	47.4725
1/15	49.7	18.6741	131.8680	13.4453	94.9449	8.9636	63.2966
1/12	62.2	23.3426	164.8350	16.8067	118.6812	11.2044	79.1208
1/10	74.6	28.0111	197.8020	20.1680	142.4174	13.4453	94.9449
1/8	93.3	35.0139	247.2524	25.2100	178.0218	16.8067	118.6812
1/6	124.0	46.6852	329.6699	33.6133	237.3623	22.4089	158.2416
1/4	186.1	70.0278	494.5049	50.4200	356.0435	33.6133	237.3623
1/3	249.0	93.3704	659.3398	67.2267	474.7247	44.8178	316.4831
1/2	373.0	140.0556	989.0097	100.8400	712.0870	67.2267	474.7247

Power		at 10,000 rpm	
hp	watts	oz-in.	m N° m
1/2000	.373	.0504	.3560
1/1500	.497	.0672	.4747
1/1000	.746	.1008	.7121
1/750	.995	.1345	.9495
1/500	1.49	.2017	1.4242
1/200	3.73	.5042	3.5604
1/150	4.97	.6723	4.4743
1/100	7.46	1.0084	7.1209
1/75	9.95	1.3445	9.4945
1/70	10.7	1.4406	10.1727
1/60	12.4	1.6807	11.8681
1/50	14.9	2.0168	14.2417
1/40	18.7	2.5210	17.8022
1/30	24.9	3.3613	23.7362
1/25	29.8	4.0336	28.4835
1/20	37.3	5.0420	35.6044
1/15	49.7	6.7227	47.4725
1/12	62.2	8.4033	59.3406
1/10	74.6	10.0840	71.2087
1/8	93.3	12.6050	89.0109
1/6	124.0	16.8067	118.6812
1/4	186.0	25.2100	178.0218
1/3	249.0	33.6133	237.3623
1/2	373.0	50.4200	356.0435

Appendix 10

Specific Resistance of Metals and Alloys at Ordinary Temperature

Substance	Specific Resistance	Relative Conductance (% Of Annealed Copper)
Aluminum, 99.57	2.828	60.97
Brass	6.00-9.00	28.70-19.10
Cobalt, 99.8%	9.70	17.70
Constantan	49.00	3.52
Copper, annealed	1.7241	100.00
Copper, pure	1.692	102.00
Silver (18X)	30.00-40.00	5.70-4.30
Iron, 99.98	10.00	17.24
Wrought Iron	13.90	12.40
Lead	22.00	7.80
Mercury	95.80	1.80
Molybdenum	5.10	34.00
Nickel	7.80	22.10
Nichrome	100.00	1.724
Platinum	10.00	17.24
Silver	1.62	106.40
Tungsten	5.40	31.90

Source: U.S. Bureau of Standards

Appendix 11

NEMA Motor Frame Dimensions

Standardized motor dimensions have been established by NEMA for all base mounted and NEMA Type C face mounted motors which carry a NEMA frame designation (42-365U). Since this is a small motor handbook, only 42-56 frames have been listed. It should be noted that NEMA does not define dimensions for motors smaller than 42.

All dimensions listed below have been excerpted from NEMA Publication No. MG-1 and are shown in inches. As of this writing, metric dimensions are under consideration but not yet finalized. The latest information can be obtained from NEMA.

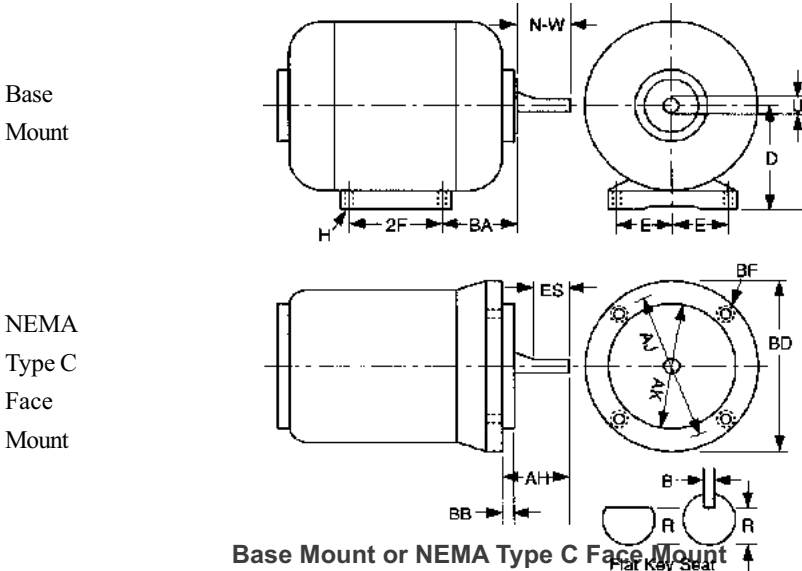

Base Mount or NEMA Type C Face Mount

NEMA Frame	D*	E	2F	BA	H Slot	U	N-W	R	ES Min.	S
42	2.62	1.75	1.69	2.062	0.28	.3750	1.12	0.328	—	flat
48	3.00	2.12	2.75	2.50	0.34	.5000	1.50	0.453	—	flat
56	3.50	2.44	3.00	2.75	0.34	.6250	1.88	0.517	1.41	0.188

NEMA Type C Face Mount Only

NEMA Frame	AH	AJ	BB Min.	BD Max.	BD Max.	BF	
						No. Holes	Tap Size
42	1.31	3.75	3.0	0.16	5.00	4	0.25-20
48	1.69	3.75	3.0	0.16	5.62	4	0.25-20
56	2.06	5.88	4.5	0.16	6.50	4	0.375-16

*Dimension D will never be greater than the above values on rigid mount motors, but it may be less so that shims up to 1/32" thick may be required for coupled or geared machines.

Appendix 12

International Voltage and Frequency Standards

As companies expand into global markets, there is an increasing need to understand specific regional issues that may differ from country to country. One area that motor application developers must be aware of is the voltage and frequency standards which specific countries have adopted. Failure to comply with these varying standards can cause severe damage to motors and their associated controls.

The following table and accompanying socket patterns are designed to assist you in determining the appropriate voltage and frequency for a given country. The list is based on information obtained from "*Electric Current Abroad*," 1991 edition, published by the U.S. Department of Congress.

Every attempt has been made to assure accuracy. However, standards do undergo periodic review and revision. Therefore it is important, in specific situations, to confirm the data in this table with the end-user's requirements.

Country	Frequency (Hz)	Voltage	
		Single-Phase	Three-Phase
Afghanistan	50	220	380
Algeria	50	127 / 220	220 / 380
American Samoa	60	120 / 240	240 / 480
Angola	50	220	380
Antigua	60	230	400
Argentina	50	220	380
Aruba	60	115 / 127	220
Australia	50	240 / 250	415 / 440
Austria	50	220	380
Azores	50	110 / 220	190 / 380
Bahamas	60	120	208 / 240
Bahrain	50	230	400
Bahrain	60	110 / 220	240
Bangladesh	50	220	440
Barbados	50	115	230
Belgium	50	220 / 230	380 / 400
Belize	60	110 / 220	220 / 440
Benin	50	220	380
Bermuda	60	120	280 / 240
Bolivia	50	115/220/230	230 / 380 / 400
Botswana	50	231	400
Brazil	60	127 / 220	220 / 380
Brunei	50	240	415
Bulgaria	50	220	380
Burkina Faso	50	220	380
Burma	50	230	400
Burundi	50	220	380
Cambodia	50	120 / 208	208 / 308
Cameroon	50	127 / 220	220 / 380
Canada	60	120	230 / 600
Canary Islands	50	127 / 220	220 / 380
Cape Verda, Republic of	50	220	380

Country	Frequency (Hz)	Voltage	
		Single-Phase	Three-Phase
Cayman Islands	60	120	240
Central African Republic	50	220	380
Chad	50	220	380
Channel Islands	50	230 / 240	400 / 415
Chile	50	220	380
China, People's Repub. of	50	220	380
Columbia	60	110 / 120 / 150	220 / 280 / 260
Commonwealth of Independent States (former USSR)	—	—	—
Comoros	50	220	380
Congo, Republic of	50	220	380
Costa Rica	60	120	240
Cote d'Ivoire	50	220	380
Cyprus	50	240	418
Czechoslovakia	50	220	380
Denmark	50	220	380
Djibouti, Republic of	50	220	380
Dominica	50	230	400
Dominican Republic	60	110	220
Ecuador	60	120 / 127	208 / 220
Egypt	50	220	380
El Salvador	60	115	230
Equatorial Guinea	50	220	NA
Ethiopia	50	220	380
Faeroe Islands	50	220	380
Fiji	50	240	415
Finland	50	220	380
France	50	110 / 127 / 220	220 / 220 / 380
French Guiana	50	220	380
Gabon	50	220	380
Gambia, The	50	220	380
Germany, Fed. Republic of	50	220	380
Ghana	50	230	400
Gibraltar	50	240	415
Greece	50	220	380
Greenland	50	220	380
Grenada	50	230	400
Guadeloupe	50	220	380
Guam	60	110 / 120	220 / 208
Guatemala	60	120	240
Guinea	50	220	380
Guinea-Bissau	50	220	380
Guyana	50 & 60	110	220
Haiti	50 & 60	110	220
Honduras	60	110	220
Hong Kong	50	200	346
Hungary	50	220	380
Iceland	50	220	380
India	50	220/225/230/300	440/450/400/600

Country	Frequency (Hz)	Voltage	
		Single-Phase	Three-Phase
Indonesia	50	127 / 220	220 / 380
Iran	50	220	380
Iraq	50	220	380
Ireland	50	220	380
Israel	50	230	400
Italy	50	127 / 220	220 / 380
Jamaica	50	110	220
Japan	50 & 60	100	200
Jerusalem	50	220	380
Jordan	50	220	380
Kenya	50	240	415
Korea	60	110 / 220	220 / 380
Kuwait	50	240	415
Laos	50	220	380
Lebanon	50	110 / 220	190 / 380
Lesotho	50	220	380
Liberia	60	120	208 / 240
Libya	50	127 / 230	220 / 400
Luxembourg	50	220	380
Macao	50	200	346
Madagascar	50	127 / 220	220 / 380
Madeira	50	220	380
Majorca	50	220	380
Malawi	50	230	400
Malaysia	50	240	415
Maldives	50	230	400
Mali, Republic of	50	220	380
Malta	50	240	415
Man, Isle of	50	240	415
Martinique	50	220	380
Mauritania	50	220	220
Mauritius	50	230	400
Mexico	60	127	220
Monaco	50	127 / 220	220 / 380
Montserrat	60	230	400
Morocco	50	127 / 220	220 / 380
Mozambique	50	220	380
Namibia	50	220 / 230	380 / 400
Nepal	50	220	440
Netherlands	50	220	380
Netherlands Antilles	50	127 / 220	220 / 380
Netherlands Antilles	60	120	220
New Caledonia	50	220	380
New Zealand	50	230	400
Nicaragua	60	120	240
Niger	50	220	380
Nigeria	50	230	415
Norway	50	230	230
Okinawa	60	100 / 120	200 / 240

Country	Frequency (Hz)	Voltage	
		Single-Phase	Three-Phase
Oman	50	240	415
Pakistan	50	220	380
Panama	60	110 / 115 / 120	220 / 230 / 240
Papua New Guinea	50	240	415
Paraguay	50	220	380
Peru	50 & 60	110 / 220	220
Phillipines	60	110 / 115	220 / 230
Poland	50	220	380
Portugal	50	220	380
Puerto Rico	60	120	240
Qatar	50	240	415
Romania	50	220	380
Rwanda	60	230	400
St. Kitts and Nevis	60	230	400
St. Lucia	50	240	416
St. Vincent	50	230	400
Saudi Arabia	60	127	220
Senegal	50	127	220
Seychelles	50	240	240
Sierra Leone	50	230	400
Singapore	50	230	400
Somalia	50	110 / 220 / 230	220 / 230 / 440
South Africa	50	220 / 230 / 250	380 / 400 / 430
Spain	50	127 / 220	220 / 380
Sri Lanka	50	230	400
Sudan	50	240	415
Suriname	60	127	220
Swaziland	50	230	400
Sweden	50	220	380
Switzerland	50	220	380
Syria	50	220	380
Tahiti	60	127	220
Taiwan	60	110	220
Tanzania	50	230	400
Thailand	50	220	380
Togo	50	127 / 220	220 / 380
Tongo	50	240	415
Trinidad and Tobago	60	115 / 230	230 / 400
Tunisia	50	127 / 220	220 / 380
Turkey	50	220	380
Uganda	50	240	415
United Arab Emirates	50	220 / 230	400 / 415
United Kingdom (England)	50	240 / 480	240 / 415
United Kingdom (Scotland)	50	240	415
United Kingdom (Wales)	50	240	415
United Kingdom (Northern Ireland)	50 —	220 / 230 —	380 / 400 —
Uruguay	50	220	220
United States of America	60	115 / 230	208 / 230 / 460

Country	Frequency (Hz)	Voltage	
		Single-Phase	Three-Phase
USSR (see commonwealth)	—	—	—
Venezuela	60	120	240
Vietnam	50	120 / 127 / 220	208 / 220 / 380
Virgin Islands (American)	60	120	240
Western Samoa	50	230	400
Yamen Arab Republic	50	220 / 230	400
Yugoslavia	50	220	380
Zaire, Republic of	50	220	380
Zambia	50	220	380
Zimbabwe	50	220	380

Information in this chart was compiled from “*Electric Current Abroad*,” July 1991 Edition of Commerce.

Glossary of Terms

Acceleration: The time rate of change of velocity; i.e., the rate at which velocity is changing, expressed as radians per second (radians/sec²). One shaft revolution = 2 π radians. See Torque-to-Inertia Ratio.

Air Gap: The space between the rotating and stationary members of an electric motor.

Alternating Current (AC): A flow of electricity which changes direction on a continuous cycle or frequency. It reaches a maximum in one direction, decreases to zero, then reverses to reach a maximum in the opposite direction.

Ambient: For air-cooled rotating machinery, ambient is the air which surrounds the motor.

Ampere: The unit of electrical current or rate of electron flow. A voltage drop of one volt across one ohm of resistance in a closed-loop electrical circuit causes one ampere of current to flow.

Ampere Turn: The measure of magnetomotive force produced by a current of one ampere in a coil consisting of one turn.

Angular Velocity: Angular displacement per elapsed unit of time (usually seconds), for example: degrees/second or radians/second.

Armature: The wound moving element in an electromechanical device such as a generator or motor.

Armature Reaction: The interaction of the magnetic flux produced by current flowing in the armature winding of a DC motor with the magnetic flux produced by the field current. The reaction reduces torque capacity, and can affect commutation and the magnitude of the motor's generated voltage.

BCD: An acronym for Binary Coded Decimal. A coded direct binary conversion of the decimal integers from 0 through 9. This conversion is shown in the following table:

Decimal Integer	Binary Coded Digit (BCD)			
	Bit 4	Bit 3	Bit 2	Bit 1
0	0	0	0	0
1	0	0	0	1
2	0	0	1	0
3	0	0	1	1
4	0	1	0	0
5	0	1	0	1
6	0	1	1	0
7	0	1	1	1
8	1	0	0	0
9	1	0	0	1

Backlash: In a mechanical system where one device is connected to another by a coupler, gear, screw, etc., the motion permitted between one device relative to the other is called backlash.

Back emf: The voltage produced across a winding of a motor due to the winding turns being cut by a magnetic field while the motor is operating. This voltage is directly proportional to rotor velocity and is opposite in polarity to the applied voltage. Sometimes referred to as counter emf.

Bifilar: Furnished or fitted with two windings which are wound simultaneously as one.

Bilevel Drive: A dual voltage drive used to overcome the effects of step motor inductance.

Binary: The base 2 numbering system consisting of only 0's and 1's.

Bipolar Drive: A drive which reverses the direction of current flow through a winding, thus eliminating the need for bifilar windings.

Braking Torque: The torque required to bring a motor down from running speed to a standstill. The term is also used to describe the torque developed during dynamic braking conditions.

Breakdown Torque: The maximum torque a motor will develop, at rated voltage, without a relatively abrupt drop or loss in speed.

Brush: A piece of current conducting material (usually carbon or graphite) which rides directly on the commutator of a commutated motor, and conducts current from the power supply to the armature windings.

Buffer: The part of a step motor translator circuit which stores incoming pulse trains.

CMOS: An acronym for Complimentary Metal Oxide Semiconductor. CMOS construction is used in integrated circuit production and is characterized by low power consumption and high speed.

Capacitor: A device which stores electricity, blocks the flow of direct current, and permits the flow of alternating current. In an AC circuit, a capacitor causes the current to lead the voltage in time phase.

Center Ring: The part of a motor housing which supports the stator, field core or permanent magnet arcs.

Centrifugal Cut-out Switch: An automatic mechanism used in conjunction with split-phase and other types of induction motors which opens or disconnects the start winding when the rotor has reached a predetermined speed. Activated by centrifugal force, the cut-out switch will reconnect the start winding when the motor speed falls below a certain level. Without these devices, the start winding would be susceptible to rapid overheating and subsequent burnout.

Chopper Driver: A circuit which limits current to the motor by switching the current off when it reaches a certain level, and switches it on again when current decays to a lower level. The switching rate is typically 2 to 20 kHz.

Clock: A circuit which generates periodic signals at regular intervals. Clock circuits are used in step motor translators to control the step rate of the motor.

Closed-Loop System: A system in which the output is fed back for comparison with the input, for the purpose of reducing any difference between input command and output response.

Cogging: A term used to describe nonuniform angular velocity. It refers to rotation occurring in jerks or increments rather than smooth continuous motion. Cogging is very apparent at low speeds. It is due to the interaction of the armature coil as it enters the magnetic field produced by the field coils or permanent magnets. The armature tends to speed up and slow down as it cuts through the fields during rotation.

Commutator: A cylindrical device mounted on the armature shaft and consisting of a number of wedge-shaped copper segments arranged around the shaft. These segments are insulated from the shaft and from each other. The motor brushes ride on the periphery of the commutator, and electrically connect and switch the armature coils to the power source.

Compliant Coupling: A coupling which allows limited freedom of movement prior to transferring torque from the input shaft to the output shaft.

Conductor: Any material such as copper or aluminum, which offers little resistance to the flow of electric current.

Coupling Angle: The mechanical degree relationship between the rotor and the rotating electrical field in a motor. While present in both synchronous and nonsynchronous AC motors, it is usually of concern in synchronous applications. At no load, the rotor poles line up exactly with the field poles, and the coupling angle is considered to be zero. When a load is applied, the lines of force coupling the rotor with the stator field are stretched, causing the rotor to fall behind the field. The mechanical angle by which the rotor lags behind the field is called the coupling angle. The coupling angle will continue to increase with load until it reaches the “pull-out” point. The maximum angle which is possible prior to pull-out is dependent on the motor type and rotor design.

Damping: The inhibition of oscillation in a system by electrical, magnetic or mechanical means.

Data Buss: A set of electrical signals whose functions have been predefined to accomplish a data transfer between two or more devices.

Distributed Pole: A motor has distributed poles when its stator or field windings are distributed in adjacent slots located within the arc of the pole.

Duty Cycle: The relationship between the operating and rest time of a motor. A motor which can continue to operate within the temperature limits of its insulation system, after it has reached its normal operating or equilibrium temperature, is considered to have a continuous duty rating. A motor which never reaches equilibrium temperature but is permitted to cool down between operations is operating under intermittent duty conditions.

Dynamic Unbalance: A vibration-producing condition caused by nonsymmetrical weight distribution of a rotating member. The lack of uniform wire spacing in a wound armature or casting voids in a rotor or fan assembly can cause relatively high degrees of unbalance.

EFSS: Acronym for Error-Free-Stop-Start. The range of motor speeds where a stepper motor can start or stop without losing or gaining steps.

Eddy Current: Localized currents induced in an iron core by alternating magnetic flux. These currents translate into heat losses. Minimizing eddy currents is an important factor in magnetic core design.

Efficiency: The ratio of mechanical output to electrical input is the measure of a motor's efficiency. It is the effectiveness with which a motor can convert electrical energy into mechanical energy.

Electrical Coupling: When two coils are situated so that some of the flux set up by either coil links some of the turns of the other, they are said to be electrically coupled.

Electrical Degree: A unit of time measurement applied to alternating current. *One complete cycle = 360 electrical degrees.* One cycle in a rotating machine is accomplished when the rotating field moves from one pole to the next pole of the same polarity. There are 360 electrical degrees in this time period. Therefore, in a two pole machine, there are 360 degrees in one revolution, so the electrical and mechanical degrees are equal. In a machine with more than two poles, the number of electrical degrees per revolution is obtained by multiplying the number of pairs of poles by 360.

Electrical Time Constant: The ratio of inductance to resistance, sometimes called the L/R time constant.

Electromotive Force (emf): A synonym for voltage, usually restricted to generated voltage.

Electronic Commutation: The use of logic circuitry to control phase current switching in a motor such as a brushless DC motor control system. The logic circuitry electronically performs the same function as a mechanical commutator. Electronic commutation eliminates the need for brushes in DC motors.

Electronic Interface: The circuitry which matches signal voltage and/or current levels between two dissimilar devices.

Encapsulated Winding: A motor which has its winding structure completely coated with an insulating resin such as epoxy. This type of construction is designed for more severe atmospheric conditions than the normal varnished winding.

Encoder: An electromechanical feedback device connected to a shaft which delivers a pulse output proportional to the motion of the shaft. Depending on the construction, an encoder can indicate either shaft position or relative shaft motion.

End Play: Inherent axial motion of the motor shaft under load, due to tolerance build-up in motor construction and bearing preload system.

End Shield: The part of the motor housing which supports the bearing and acts as a protective guard to the electrical and rotating parts inside the housing. It may also be referred to as the end bracket or end bell.

Excitation Current: A term usually applied to the current in the shunt field of a motor resulting from voltage applied across the field.

Excitation Sequence: In stepper motors, the sequence in which the motor phases (windings) are energized. This sequence of individual phase excitation establishes both direction and step size (full or half steps). A specific excitation sequence is required for each type of drive employed (unipolar or bipolar) as well as each step size required.

Farad: A unit of measure for electrical capacitance. A capacitor has a capacitance of one farad when a potential difference of one volt will charge it with one coulomb of energy.

- Feedback:** The return of a signal from the output of a circuit to its input for the purpose of comparing the output with a reference signal. This is done to automatically compensate the input to maintain a desired output condition. See Closed-Loop System.
- Ferromagnetic:** A material with high magnetic permeability or one which imposes little resistance to magnetic orientation of its molecular structure in the presence of a magnetic field. Such materials as iron, steel and nickel are ferromagnetic substances.
- Field:** A term commonly used to describe the stationary (stator) member of a DC motor. The field provides the magnetic field with which the mechanically rotating (armature) member interacts.
- Field Weakening:** The introduction of resistance in series with the shuntwound field of a motor to reduce the voltage and current which weakens the magnetic field and thereby increases motor speed.
- Flux:** The magnetic field which is established around an energized conductor or permanent magnet. The field is represented by flux lines, creating a flux pattern between opposite poles. The density of the flux lines is a measure of the strength of the magnetic field.
- Form Factor:** A figure of merit which indicates to what degree rectified current departs from nonpulsating or pure DC. Pure DC has a form factor of 1.0. A large departure from unity form factor increases the heating effect of the motor and reduces brush life. Mathematically, form factor is the ratio of the root-mean-square (rms) value of the current to the average current or I_{rms}/I_{av} .
- Fractional Horsepower Motor:** A motor with a continuous rating of less than one horsepower.
- Frequency:** The rate at which alternating current reverses its direction of flow, measured in hertz (Hz). $1 \text{ Hz} = 1 \text{ cycle per second}$.
- Friction (Coulomb):** A force of constant magnitude and independent of velocity which opposes the relative motion of two surfaces. A constant minimum torque is required to overcome friction and produce motion.
- Friction (Viscous):** A force which opposes the relative motion of two surfaces and is dependent on the relative velocity of the surfaces, due to the viscosity of the fluid medium separating them.
- Full Load Current:** The current drawn when the motor is operating at full load torque and full load speed at rated frequency and voltage.
- Full Load Torque:** The torque necessary to produce rated horsepower at full load speed.
- Full Step (Two Phase On) Drive:** A mode of operation in which the windings of a stepper motor are energized in sequence, maintaining two windings (phases) in the "on" state at any one time.
- Galvanometer:** An extremely sensitive instrument used to measure small values of current and voltage in an electrical circuit.
- Gearhead:** The portion of a gearmotor which contains the actual gearing for converting the rated motor speed to the rated output speed.

Generated Voltage: A voltage produced whenever conductors of electric current cut across lines of magnetic force, as in a motor being driven as a generator.

Gravity Load: A load which is produced by gravitational force. A gravity load is seen by the motor as an inertial load plus a unidirectional torque.

Grounded Motor: A motor with a short circuit between any point in its electrical circuit and its connection to ground.

Half-Step Drive: A mode of operation in which one and two phases of a stepper motor are alternately energized in a particular sequence, resulting in step angles one-half that of a full step drive. The motor shaft rotates at one half the speed of full step operation at a given pulse rate.

Heat Loss: Losses due to resistance take the form of heat which has to be dissipated into the air or surrounding cooling medium. Heat loss is also referred to as I^2R loss because the current squared, multiplied by the resistance, will yield the heat loss value in watts.

Holding Torque: See Static Torque.

Home Position: A known position to which a system (a stepper motor or incremental encoder) can be set to establish a starting position or reference point.

Hybrid Stepper Motor: A motor combining the properties of both variable reluctance and permanent magnet stepper motor designs. The rotor includes a cylindrical magnet captivated within two soft iron-toothed cups. The magnet provides part of the operating flux of the motor.

Hysteresis Loss: The resistance of a material to becoming magnetized (magnetic orientation of molecular structure) results in energy being dissipated and a corresponding loss. Hysteresis loss in a magnetic circuit is the energy expended to magnetize and demagnetize the core.

Impedance: The total opposition a circuit offers to the flow of alternating current at a given frequency. It is the vectorial sum of the circuit's resistance and reactance.

Impedance Protection: A motor which is designed so that it limits current to a value less than that which would result in overheating under all operating conditions, especially locked rotor conditions, is said to be impedance protected.

Indexer: The part of a stepper motor control system which commands the motor to rotate through a specific predetermined number of steps.

Inductance: The property of a circuit which opposes any change of current because of the magnetic field associated with the current itself. The unit of inductance is the henry. When a current changing at the rate of one ampere per second induces a voltage of one volt, the inductance of the circuit is one henry. Inductance causes current to lag the voltage in time phase.

Inertial Load: A load (flywheel, fan, etc.) which tends to cause the motor shaft to continue to rotate after the power has been removed. If this continued rotation cannot be tolerated, some mechanical or electrical braking must be applied.

Inertial Load-Reflected: The inertia of the load as seen by the motor when driving the load through a gear reducer or other speed changing system.

- Insulator:** A material which tends to resist the flow of electric current such as glass, paper, rubber, etc.
- Integral Horsepower Motor:** In terms of horsepower, a motor built in a frame having a continuous rating of one horsepower or more. In terms of motor size, an integral hp motor is usually greater than 9 inches in diameter, although it can be as small as 6 inches.
- Line Voltage:** Voltage supplied by the commercial power company or voltage supplied as input to the device.
- Locked Rotor Current:** Steady state current taken from the line with the rotor at standstill (at rated voltage and frequency).
- Locked Rotor Torque:** The minimum torque that a motor will develop at rest for all angular positions of the rotor, with rated voltage applied at rated frequency.
- Logic Circuit:** A circuit which exchanges and processes information in the form of binary digital data.
- Magnetomotive Force (mmf):** The magnetic energy supplied with the establishment of flux between the poles of a magnet. Magnetomotive force is analogous to electromotive force in an electric circuit.
- Mechanical Degree:** The more popular physical understanding of degrees; i.e., *360 degrees = 1 revolution*.
- Microprocessor:** The control and calculating portion of a small computer system that is integrated into a single chip.
- Mini-Stepping:** The process of electronically subdividing the inherent step size of a stepper motor into smaller increments.
- Natural Frequency:** The frequency at which a system will oscillate from rest position when displaced by a momentary force. Stepper motor operation at a natural frequency is unstable. This instability may be overcome by adding frictional torque to the system.
- Open Circuit:** Any break in a current path, in an electrical circuit, which causes an interruption of current flow.
- Open-Loop System:** A control system in which no feedback path exists. The output has no effect on the input, as in a closed-loop system.
- Overhung Load:** A load which exerts a force on the motor shaft perpendicular to the rotational axis of the shaft. Also called radial load.
- Overshoot:** Motion which is beyond the commanded position. For a stepper motor, overshoot is the maximum or minimum peak displacement shown on a single step response curve, and is usually dimensioned as a percent of one step.
- Phase:** In motor terminology, phase indicates the spatial relationship of windings and the changing values of recurring cycles of AC voltage and current. The positioning of the windings in a motor (or phase relationship) causes dissimilarities between any given winding voltage and current at any given instant. Each voltage or current will lead or lag the other in time.

Phase Displacement: Mechanical or electrical angle by which phases in a polyphase motor are displaced from each other. It also applies to the mechanical or electrical angle by which the main winding and the capacitor or start winding are displaced in an induction motor.

Plug Reversal: Reconnecting a motor's windings to reverse its direction of rotation while it is running. Plugging is a very severe method of reversing and should be used with extreme caution. Other methods of mechanical or dynamic braking should be used.

Polarities: Terms such as positive, negative, north and south, which indicate the direction of current and magnetic flux flow in electrical and magnetic circuits at any instant in time.

Polarized Motors: Special motors consisting of hybrid cores which are partially squirrel cage (reluctance type) and partially permanent magnet. Polarized motors can lock into synchronism in a definite relationship to the stator poles. Two-pole polarized motors have only one lock-in position, while four-pole polarized motors have two lock-in positions 180° apart. (Standard reluctance type synchronous motors have as many lock-in points as there are poles in the motor.)

Potentiometer: A variable resistor which, when connected in series with a motor, can be used to adjust the amount of voltage available to the motor and thereby adjust the speed of the motor.

Power Factor: A measurement of the time phase difference between the voltage and the current in an AC circuit. It is represented by the cosine of the angle of this phase difference. For an angle of 0°, the power factor is 100%, and the voltage / amperes of the circuit are equal to the watts.

Primary Winding: The winding of a motor, transformer or other electrical device which is connected to the power source.

Programmable Controller: A solid state digital logic device which allows programmed instructions to control electromechanical devices in a motion control system via properly timed switch actuations.

Pull-In Torque: The maximum frictional load a motor is capable of bringing to synchronous speed from a standstill. Fhp synchronous motor ratings are based on pull-in torque measurements.

Pull-Up Torque: The minimum torque developed by an AC motor during the period of acceleration from zero to the speed at which breakdown occurs. For motors which do not have a definite breakdown torque, the pull-up torque is the minimum torque developed during the process of getting up to rated speed.

Pulse: An electrical signal of unusually short duration and often square in shape.

Rated Speed: The speed which a motor develops at rated voltage with rated load applied.

Reactance (Inductive): The characteristic of a coil, when connected to alternating current, which causes the current to lag the voltage in time phase. The current wave reaches its peak later than the voltage wave.

Rectifier: An electronic circuit which converts alternating current to direct current.

- Reluctance:** The characteristic of a magnetic material which resists the flow of magnetic lines of force through the material.
- Residual Torque:** The holding or restoring torque of a nonenergized stepper motor (all windings open) which tends to restore the rotor to a detent position. Sometimes referred to as detent torque.
- Resilient Mounting:** A suspension system or cushioned mounting designed to reduce the transmission of normal motor noise and vibration to the mounting surface.
- Response Time:** The time required for a stepper motor to initially reach its next commanded position.
- Resonance:** In open-loop stepper systems, a speed range in which a low frequency velocity oscillation occurs around the nominal speed. It grows in amplitude until the rotor velocity can no longer follow the command pulse train, and the motor stalls.
- Rotor:** The rotating member of an induction motor, stepper, brushless DC or switched reluctance motor.
- Rotor Inertia:** The property of the rotor which resists any change in motion. The inertia is a function of rotor mass and radius squared, and is expressed as oz-in./sec²** or gm-cm².
- Salient Pole:** A motor has salient poles when its stator or field poles are concentrated into confined arcs and the winding is wrapped around them (as opposed to distributing them in a series of slots).
- Silicon Controlled Rectifier (SCR):** A semiconductor device which blocks a voltage applied to it in either direction when it is in its normal state. It will conduct in a forward direction when a signal of the proper amplitude is applied to its gate. Once conduction begins, it continues even if the control signal is removed. Conduction will stop when the anode supply is removed, reversed or reduced sufficiently in amplitude.
- Secondary Winding:** The secondary winding of a motor (i.e., squirrel cage rotor conductors) is one which is not connected to the power source, but which carries current induced in it through its magnetic linkage with the primary winding.
- Semiconductor:** A solid or liquid having a resistive value midway between that of an insulator and a conductor. Typical semiconductor materials are germanium, silicon, selenium and lead sulfide. These materials are used to manufacture active electronic devices such as transistors, diodes, SCRs, and integrated circuits (ICs), which are used extensively in motion control systems.
- Settling Time:** The time required for a stepper motor to reach and remain within $\pm 5\%$ of a single step, after commanded to take a single step.
- Service Factor:** In motor applications, it is a figure of merit used to adjust measured loads in an attempt to compensate for conditions which are difficult to measure and define. Typically, measured loads are multiplied by service factors (experience factors), and the result is an “equivalent required torque” rating of a motor or gearmotor.
- Shaft Run-Out:** The variation in distance between the surface of a shaft and a fixed point outside the shaft through one shaft revolution.

Short Circuit: A defect in an electrical circuit which causes part of the circuit to be bypassed. This frequently results in reducing the resistance to such an extent that excessive current flows in the remaining circuit and results in overheating and subsequent burn-out.

Skew: The arrangement of laminations on a rotor or armature to provide a slight diagonal pattern of their slots with respect to the shaft axis. This pattern helps eliminate low speed cogging effects in an armature and minimizes induced vibration in a rotor.

Slew Range: The speed range through which a stepper motor may be operated using acceleration and deceleration control, without losing or gaining steps.

Slip: The difference between the speed of the rotating magnetic field (which is always synchronous) and the rotor in a nonsynchronous induction motor. Slip is expressed as a percentage of synchronous speed. It generally increases with an increase in load.

Starting Current: Amount of current drawn when a motor is initially energized. It usually exceeds the current required for running.

Starting Torque: The torque or twisting force delivered by a motor when initially energized. Starting torque is often higher than rated running torque.

Static Torque: The torque under locked rotor conditions, when one or two of the phase windings of a stepper motor are excited with a steady state DC current. Static torque varies as the motor shaft is rotated through one step or more in either direction.

Stator: That part of an induction motor, stepper, brushless DC or switched reluctance motor which does not rotate.

Step Accuracy: The maximum deviation of a stepper motor from true position under no-load conditions. Step accuracy is noncumulative in a stepper motor; i.e., the maximum deviation from true position is never more than the maximum single step deviation.

Step Angle: The angle through which a stepper motor shaft rotates to take a single step. For Bodine stepper motors, the step angle is 1.8° .

Step Rate: The rate in steps per second at which a stepper motor is commanded to operate.

Synchronous Speed: The speed of the rotating magnetic field set up by an energized stator winding. In synchronous motors, the rotor locks into synchronism with the field and is said to run at synchronous speed.

Tachometer: A small generator normally used as a velocity sensing device. Tachometers are attached to the output shaft of DC motors and typically used as feedback devices. The tachometer feeds its signal to a control which compares it to the reference signal. The control then adjusts its output accordingly to regulate the speed of the motor to within a predefined tolerance.

Thermal Protection: Motors equipped with devices to disconnect the motor windings from the line during overheating are said to be thermally protected.

Thermocouple: A temperature sensor containing a junction of two dissimilar materials which generates a minute voltage in proportion to its temperature. Such devices may be used as a signal source for control equipment to indicate overheating conditions.

Thrust Load: A load which applies a force to the motor shaft in a direction parallel to the shaft.

Time Constant: The time interval in which a variable (which is a function of time) reaches 63% of its maximum value.

Torque: The twisting force of a motor or gearmotor shaft, usually expressed in ounce-inches or newton-meters. *Torque = force x distance.*

Torque-to-Inertia Ratio: The ratio of available torque to the inertia of the rotor. The ratio T:J is proportional to the acceleration the motor can achieve. The greater the ratio, the greater the motor's acceleration capability.

Translator: The portion of a stepper motor control which translates a clock signal into the proper excitation sequence to operate the motor.

Unipolar Drive: A drive in which winding current flows in one direction only.

Voltage: The force which causes current to flow in an electrical circuit. Analogous to hydraulic pressure, voltage is often referred to as electrical pressure.

Voltage Drop: The loss encountered across a circuit impedance. The voltage drop across a resistor takes the form of heat released into the air at the point of the resistance.

Watt: The amount of power required to maintain a current of one ampere at a pressure of one volt. *One horsepower = 746 watts.*

Index

ANSI	A-1
AC	
circuits	1-16
method for load measurement ..	7-24
motor action	2-1
motors	2-1
rectification	8-22
absolute optical encoders	9-3
acceleration	1-21
angular	1-22
time	1-25
actuation methods	10-5
electromagnetic	10-6
hydraulic	10-7
mechanical	10-7
pneumatic	10-6
actuators	8-2
controls	8-3
adjustable speed	7-29
air gap	7-12
alignment	7-43
alloys	5-3
aluminum-nickel-cobalt-iron ..	5-5
amorphous	5-4
iron-silicon	5-4
neodymium-iron-boron	5-5
rare-earth cobalt	5-5
soft ferrites	5-4
alnico	5-5
alternating current	1-2
three-phase	1-14
two-phase	1-14
aluminum-nickel-cobalt-iron	
alloys	5-5
ambient temperature	7-35
amorphous alloys	5-4
ampere	1-2
ampere turns	7-12
ampere-turns ratio	7-14
angular	
acceleration	1-22
displacement	1-21
velocity	1-21
application	
of motors	7-1
data sheet	7-27
guidelines	7-25
applying fhp gearmotors	7-38
armature	3-1
current	3-3
reaction	3-9
resistance	3-3
resistance control	8-14
armature (cont.)	
slots	7-14
voltage control	3-7, 8-15
atom	1-1
atomic theory	1-1
axial loads	7-32
backdriving	6-5
backlash	3-9
ball bearings	5-8
ball bearing noise	7-10
bearings	5-6
sleeve (journal)	5-6
ball	5-8
needle	5-8
bearing selection	5-6
binary coded digit (BCD)	9-4
bevel gears	6-3
bipolar circuits	8-35
braking	7-38
brushes	5-9
carbon	5-10
carbon graphite	5-10
electro-graphitic	5-10
graphite	5-10
metal-graphite	5-11
worn	7-43
brush-type DC motors	3-1
commutation of	3-2
counter emf and armature	
current	3-3
speed control of	3-3
types of	
series wound	3-3
shunt-wound	3-6
permanent magnet	3-8
brushless DC motors	3-11
operation of	3-12
controls for	8-29
brush selection	5-11
CSA	7-2, A-1
capacitance	1-4
capacitive reactance	1-18
capacitive time constant	1-6
capacitor motors	2-7
capacitor start	2-8
permanent split capacitor ..	2-9
two capacitor start / one	
capacitor run	2-9
cemf	3-3
centrifugal switch	2-6
ceramic magnet	3-10
change in frequency	8-39
change in number of poles	8-18

changing rotor slip	8-19	switched reluctance	8-42
circuits		variable transformer	8-17
AC	1-12	vector	8-41
bipolar	8-35	controllers	8-2
capacitance	1-18	proportional	8-4
DC	1-12	proportional plus derivative	8-4
inductive	1-17	proportional plus integral	8-4
parallel	1-3	proportional plus integral plus derivative	8-4
series	1-3	control systems	8-3
unipolar	8-35	closed-loop	8-3
closed-loop	8-3	open-loop	8-3
clutches	10-1	servo (type 0, type 1, type 2)	8-4
friction techniques	10-2	controls, motor	8-12
cone	10-2	active type	8-21
disc	10-2	actuator	8-2
drum	10-2	change in frequency method	8-39
electromagnetic techniques	10-2	changing rotor slip method	8-19
eddy current	10-3	for brushless DC motors	8-29
hysteresis	10-3	for stepper motors	8-32
magnetic particle	10-4	bilevel	8-34
mechanical lock-up techniques	10-4	chopper	8-33
roller ramp	10-5	Series R	8-32
square jaw	10-4	electric commutation	8-29
spiral jaw	10-4	passive type	8-12
toothed	10-5	AC motor	8-17
sprag	10-5	permanent magnet	8-15
wrap spring	10-5	series wound	8-16
commutation	3-2	shunt-wound DC	8-13
commutator	1-14	pole-changing method	8-18
compensation	8-26	pulse width modulation type	8-28
IR	8-26	SCR type	8-23
line voltage	8-27	full-wave	8-25
RFI suppression	8-27	half-wave	8-24
surge suppression	8-27	sensors	8-3
temperature	8-27	signal interfaces	8-3
torque limiting	8-27	solid state type	8-39
compound wound motors	10-10	system controller	8-2
conductor	1-2	copper loss	1-3
connection	7-40	coulomb	1-4
connection diagrams	CD-1	counter emf (cemf)	3-3
AC polyphase	CD-2	coupling angle	2-12
AC single-phase	CD-1	current	1-2
DC	CD-3	alternating	1-2
DC stepper	CD-5	direct	1-2
brushless DC	CD-6	DC	
contamination	7-43	method for load measurement	7-24
continuous load	7-30	motors	3-1
control	8-12	brush-type	3-1
armature resistance	8-13	speed control of	3-3
armature voltage	3-7, 8-15	DIN	7-2
enclosures, standards for	8-42	dampers	8-38
field weakening	8-13	eddy current	8-38
series resistance	8-16	ferrofluidic	8-38
shunt resistance	8-16		

dampers (cont.)		electronically commutated motor	3-14
mechanical	8-38	electrons	1-1
viscous	8-38	emf	1-10
definite purpose motors	7-6	encapsulated windings	5-15
Delta-connection	1-15	encoders	9-2
demagnetization	1-9	absolute	9-3
diamagnetic materials	1-7	incremental	9-3
dielectric	1-5	linear	9-5
constant	1-5	magnetic rotary	9-4
direct current	1-12	optical rotary	9-3
direct drive servo motors	4-9	end play	7-37
direction of rotation	7-29	energy management	7-19
directly driven loads	7-32	environmental conditions	5-13
displacement	1-21	unusual	5-14
drip-proof motor	5-14	usual	5-13
dust ignition-proof motor	5-15	environmental protection	5-13, 8-45
duty cycle	4-5	epicyclic gear trains	6-6
dynamic braking	10-7	error-free-start-stop	8-36
of AC induction motors	10-11	explosion-proof motor	5-15
permanent split capacitor	10-12	externally ventilated motor	5-14
shaded pole	10-12	fan-cooled motor	5-15
split-phase	10-12	fan noise	7-11
three-phase (polyphase)	10-13	farad	1-4
of DC motors	10-8	Faraday's Law	1-11
compound wound	10-10	feedback	
permanent magnet	10-9	devices	9-1
series wound	10-9	techniques	8-3
shunt-wound field	10-8	closed-loop	8-3
of gearmotors	10-14	open-loop	8-3
estimating torque	10-15	transducers	9-1
high inertia for	10-17	ferrites	5-5
with spur and helical		ferromagnetism	1-7
gearing	10-17	field weakening control	8-13
with worm gearing	10-17	filtering	8-23
evaluation of	10-18	fixed speed	7-29
dynamic unbalance	7-10	flux	1-7
EIA	A-1	density	1-7
eddy current effect	5-2	line	1-8
effective value	1-16	form factor	8-23
efficiency	7-19	force	1-22
electric current	1-1	fractional horsepower gearmotors	4-1
alternating	1-12	frequency	7-13
conventional flow	1-2	friction technique	10-3
direct	1-12	full-wave	
electron flow	1-2	rectification	8-22
electrical		SCR controls	8-25
leads	7-37	gate signal	8-24
noise	7-12	gearing	6-1
time constant	8-32	annulus	6-6
electromagnetic actuation	10-6	bevel	6-3
electromotive force (emf)	1-10	double helical	6-3
electronic		helical	6-2
antiresonance	8-37	herringbone	6-3
commutation	8-29		

gearing (cont.)	
hypoid	6-3
planet	6-6
rack and pinion	6-2
service factors	7-39
spiral bevel	6-3
spur	6-1
sun	6-6
worm	6-3
gearmotors	4-1
application of	7-25
dynamic braking of	10-14
fractional horsepower	4-1
lubrication of	6-6, 7-46
mounting of	7-47
operating hazards	7-8
rating of	7-7
gear trains	6-4
combination	6-6
epicyclic	6-6
planetary	6-6
solar	6-6
star	6-6
noise from	7-12
parallel shaft	6-4
right angle	6-4
general purpose motors	7-3
generator action	1-10
gray code	9-4
guarded motor	5-14
half-wave	
SCR controls	8-24
rectification	8-22
hall effect devices	3-13
hard magnetic materials	5-4
helical gears	6-2
Henry	1-11
horsepower	1-3
horsepower/watts vs. torque	
conversion	A-12
hypoid gears	6-3
hydraulic actuation	10-7
hysteresis	1-9
synchronous motors	2-13
IEC	7-2
IEEE	7-1, A-1
IR compensation	8-26
I ² R loss	1-3
ISO	7-2, A-1
impedance	1-19
protected motors	7-17
incremental encoders	9-3
induced emf	1-10
inductance	1-11
induction motor	2-1
inductive reactance	1-17
industry standards	7-1
inertia	1-22, 8-38
moment of	1-27
rotational	1-22
ingress protection	8-45
inspection	7-40, 7-43
insulation systems	5-12
insulator	1-2
installation	7-40
interfaces, signal	8-3
intermittent operation	7-30
iron-silicon alloys	5-4
“ironless” armature	4-10
journal bearings	5-6
left-hand rule	A-5
life expectancy	7-34
linear	
encoders	9-5
induction motors	4-7
speed / torque characteristics	8-6
line voltage compensation	8-27
load	
inertia	1-25
requirements	7-29
torque measurement	7-22
loss	7-20
electrical	7-21
hysteresis	1-10
I ² R	1-3
iron	7-21
mechanical	7-21
motor	7-20
power	1-3
low carbon iron	5-3
low speed AC synchronous	
motors	4-2
lubrication	7-44
ball bearing	7-44
sleeve bearing	7-44
gearmotor	6-6, 7-46
magnet	1-6
magnetic	
field	1-6
field strength	1-9
flux density	1-7
materials	5-2
hard	5-4
soft	5-3
moment	1-7
pick-ups	9-6

magnetic (cont.)	
polarity	1-8
rotary encoders	9-4
saturation	1-9
steels	5-4
magnetism	1-6
magnetization	1-9
maintenance	7-22, 7-42
mass	1-2
mechanical	
actuation	10-7
noise	7-10
principles	1-20
metric conversions	A-10
momentum	1-22
motion	1-20
rotational	1-21
translational	1-21
motion control systems	8-2
motor	
action	1-10
application data	7-25
characteristics	7-26
control types	8-12
failure	7-43
load	1-23
losses	7-20
mounting	7-35, 7-47
resilient	7-15
operation	8-5
four quadrant	8-10
hazards	7-8
single quadrant	8-6
two quadrant	8-6
selection	7-40
sizing	7-24
NEC	7-16
NEMA	7-1, A-1
motor frame dimensions	A-18
shaft rotation	7-29
standards	7-2
N-type materials	8-24
nameplate ratings	7-3
neodymium-iron-boron alloys	5-5
noise	7-10
control	7-14
nonsynchronous motor	2-4
nonventilated motor	5-15
Oersted	1-7
ohm	1-2
Ohm's Law	1-2
open-loop	8-3
open motor	5-14
operating	
guidelines	7-41
limitations	8-37
temperature	7-47
optical rotary encoders	9-3
oscillation	8-38
overhung loads	7-31
overloading	7-43
overload protection	7-38
P-type materials	8-24
PM	
3-8	
hybrid motors	3-15
motors	3-8
stepper motors	3-15
PSC motors	2-9
pancake motor	4-11
parallel	
circuit	1-3
shaft gear trains	6-4
paramagnetic materials	1-7
passive device motor controls	8-12
permanent magnet (PM) motors	3-8
controls for	8-15
permanent split capacitor (PSC)	
motors	2-9
permeability	1-9
phase angle	1-16
plugging	3-7, 10-10
pneumatic actuation	10-6
polyphase	
motors	2-2
power supplies	8-39
potential difference	1-2
power	1-2
factor	1-16
loss	1-3
supply	7-26
polyphase	8-39
single-phase	8-41
primary cell	1-12
printed circuit (PC) motors	4-11
process control systems	8-2
batch	8-2
continuous	8-2
discrete	8-2
pull-out torque	2-12
pulse width modulation	8-28
pure capacitance circuit	1-18
pure inductive circuit	1-17
pure resistance circuit	1-16
RC AC circuit	1-19
RC circuit	1-5

RFI suppression	8-27	semiconductor	1-2
RL AC circuit	1-18	semiguarded motor	5-14
RL circuit	1-11	sensors	8-3
RL time constant	1-12	series	
RLC AC circuit	1-20	circuit	1-3
radial loads	7-31	resistance control	8-16
ramping	8-37	wound motor	3-3
rare earth-cobalt alloys	5-5	service	7-42
rated		factor	7-5
horsepower	7-4	servo	
speed	7-8	control systems	8-4
torque	7-7	motors	4-8
rating	7-3	direct-drive	4-9
definite purpose motors	7-6	shaded pole motors	2-10
flhp gearmotors	7-7	shading coil	2-11
general purpose motors	7-3	shell-type armature motors	4-9
special purpose motors	7-6	shock loads	7-30
rating point	8-9	shunted armature connection	8-15
ratings, nameplate	7-3	shunt resistance control	8-16
rectification	8-22	shunt-wound	
reference voltage	8-26	motors	3-6
regenerative drives	8-12	brush life in	3-7
regulated speed	8-10	motor controls	8-13
relubrication	7-46	armature connection	8-15
reluctance synchronous motors	2-12	armature resistance	8-14
resistance	1-2	armature voltage	8-15
resistor	8-12	field weakening	8-13
value codes	A-4	silicon controlled rectifier (SCR)	8-24
resolver	9-5	signal interfaces	8-3
resonance	8-37	sine wave	1-13
low-frequency	8-37	single-phase	
mid-frequency	8-37	motors	2-5
reversing motor direction	8-11	power supplies	8-41
rheostat	8-1	six step method	8-40
right angle gear trains	6-4	skewing	2-5
right-hand rule	A-5	sleeve bearings	5-6
ringing	8-38	sleeve bearing noise	7-11
root-mean-square	1-16	slew speed	8-37
rotational		slip	2-4
inertia	1-22	controlling	8-19
motion	1-21	rotor	8-18
rotary encoders	9-2	slip ring	1-13
rotor	2-4	soft magnetic materials	5-3
SCR	8-24	solenoid	1-8
phase control	8-23	special purpose motors	7-6
SI	7-3, A-10	speed	1-21
safety	7-40	control	3-3
salient pole	2-11	regulation	8-10
effect	7-13	speed / torque	
saturation	7-12	characteristics	8-6
Scott T transformer	9-6	curve	7-25
sealed windings	5-15	splash-proof motor	5-14
secondary cell	1-12	split-phase motors	2-5
self-inductance	1-17	springs	5-12

spur gears	6-1	time constant	1-6
squirrel cage rotor	2-4	RC	1-6
starting		RL	1-12
torque	2-5	torque	1-23
under load	7-32	accelerating	1-23
stator	2-1	breakaway	1-23
poles	7-13	characteristics	1-23
teeth	7-13	constant	1-23
stepper motors	3-14	constant (K_c)	8-8
operating speeds	8-36	limiting	8-27
performance	8-36	motors	4-3
PM	3-15	peak	1-23
PM hybrid	3-15	pull-in	2-12
slew speed of	8-37	pull-out	2-12
variable reluctance	3-15	sinusoidal	3-13
string and pulley	7-23	trapezoidal	3-13
suppression	8-27	variable	1-25
RFI	8-27	wrench	7-23
surge	8-27	totally-enclosed motor	5-14
switched reluctance		transformer	1-12
controls	8-42	transistor	8-28
motors	4-6	translational motion	1-21
synchro	9-5	two capacitor start/one capacitor	
synchronous		run motor	2-9
motors	2-12	two-phase AC	1-14
hysteresis	2-13	UL	7-2,
reluctance	2-12	A-1	
speed	2-4	requirements	7-18
system		unipolar circuits	8-35
controllers	8-2	universal motor	3-4
efficiency	7-21	VDE	7-2,
TENV	3-10	A-1	
tachometer generator	9-2	variable reluctance(VR) motors	3-15
tapped winding	8-20	variable transformer control	8-17
temperature	7-34	varistor	8-27
compensation	8-27	velocity	1-21
conversions	A-9	ventilation	7-36
“test” motor	7-24	vibration	7-10
thermal protection	7-16	voltage	1-2
devices	7-16	constant (K_v)	8-8
NEC requirements	7-16	drop	1-3
UL requirements	7-18	waterproof motor	5-15
thermal time constant	4-10	watt	1-3
thermostats	7-17	weather-protected motor	5-14
in-the-winding	7-17	weight limitations	7-35
manual reset	7-17	winding change method	8-21
on-the-winding	7-17	windings	1-3
third party approvals	7-40	insulation	5-13
three-phase AC	1-14	wiring	7-41
thrust		inadequate	7-43
loads	7-32	worm gears	6-3
washers	5-9	Wye-connection	1-15
noise from	7-11		
thyrector	8-27		

Motor Windings—Custom and Standard Options

Winding design is one of the major factors that determines gearmotor performance. For example, the windings may be driven by AC or DC current. They may require a capacitor, or a control to run, and may be configured as single, split or three-phase systems. Some motor types provide precise speed and position control, while others are less accurate. They may be built to run at either a constant or variable speed. Understanding these differences is critical to selecting the right gearmotor for your application.

As a manufacturer that exclusively focuses on fractional horsepower (less than 1 HP/746 Watts) products, Bodine Electric Company offers a range of standard gearmotors and motors with the most common voltage and frequency ratings for both the North American and International markets. Bodine Electric also has the engineering expertise to design and manufacture a great variety of custom winding types and ratings.

AC Induction, Permanent Magnet DC and Brushless DC (ECM) Motor Winding Performance Characteristics

Motor Winding	Speed Tolerance	Typical Rated Speeds at 60 Hz	Start/Stop Frequency	Coast Without Brake (Rev)	Coast With Dynamic Braking (Rev)	Starting Torque (% of Rated Torque)	Pros	Cons
AC Windings								
Split Phase (SI)	±3%	1700-1750 (4-pole)	Up to 6 per hour	20-600	0.5-6	175% and up	No capacitors	Switch life 50k to 250k starts
		3450 (2-pole)						
Permanent Split Capacitor (CI)	±3%	1700-1750 (4-pole)	Up to 10 per min.	20-600	0.5-6	90-100%	Very reliable, Low starting current	Low starting torque
		3450 (2-pole)						
Three Phase ¹ (PP, Non-synchronous)	±3%	1700-1750 (4-pole)	Up to 10 per min.	20-600	0.5-6	200- 400%	Most reliable and efficient, No cap/switch	Requires three-phase power, or a control
		3450 (2-pole)						
Reluctance Synchronous Split Phase (SY)	near 0%	1800 (4-pole)	Up to 6 per hour	20-600	0.5-6	110-150%	Same as split-phase, plus exact speed	Switch life 50k to 250k starts
		3600 (2-pole)						
Reluctance Synchronous Capacitor (YC)	near 0%	1800 (4-pole)	Up to 10 per min.	20-600	0.5-6	80-100%	Exact speed, Very reliable, Low starting current	Low starting torque
		3600 (2-pole)						
Reluctance Synchronous Three Phase (YP) ¹	near 0%	1800 (4-pole)	Up to 10 per min.	20-600	0.5-6	200-500%	Exact speed, Most reliable and efficient, No cap/switch	Requires three-phase power, or a control
		3600 (2-pole)						
DC Windings								
Permanent Magnet DC	0-1%	2500 (130V DC)	Up to 10 per min.	10-20	0.5-6	175% and up	Linear speed/torque characteristics	Requires a control
Brushless DC (BLDC)	near 0%	2500 (130V DC)	Up to 10 per min.	20-600	0.5-6	175% and up	Exact speed control, Linear speed/torque characteristics	Requires a control

1. Fixed and variable speed options available



Bodine offers over 1,200 standard gearmotors, motors and system-matched speed controls.



201 Northfield Road | Northfield IL 60093 U.S.A. | Tel: 773.478.3515 | Fax: 773.478.3232
info@bodine-electric.com | www.bodine-electric.com

STANDARD PRODUCTS

GEARMOTORS • MOTORS • CONTROLS

AC
PMDC
BLDC



BODINE
ELECTRIC
COMPANY

bodine-electric.com

Motors Without Gearing [Inverter Duty AC](#), [Fixed-Speed AC](#), [Permanent Magnet DC](#), and [Brushless DC](#)

Bodine fixed-speed AC motors are available with three winding types: permanent split capacitor, split phase, or three-phase. Inverter duty AC 3-phase motors can be used with VFDs for variable speed operation. AC motors are available with voltage ratings of 115 VAC, 60 Hz (single-phase), 230 VAC, 60 Hz (3-phase) and 230/460 VAC, 60 Hz (3-phase). Our metric/international models are rated 230 VAC, 50 Hz (1- or 3-phase). PMDC motors are available with voltage ratings of 12/24 VDC, 24 VDC, 90/130 VDC, 130 VDC and 180 VDC (metric). Brushless DC motors are available with voltage ratings of 24 and 130 VDC. We also offer four frame sizes of AC torque motors for holding applications.

	Variable Speed Pacesetter Inverter Duty AC				Fixed-Speed AC				Permanent Magnet DC			Brushless DC		INTEGRA BLDC		
	30R	34R	42R	48R	K-2	30R	34R	42R	48R	24A	33A	42A	22B	34B	22B	34B
Power (HP)	1/25 - 1/17	1/8 - 1/4	3/8	1/3 - 3/4	1/1600 - 1/200	1/40 - 1/30	1/15-1/5	1/12-1/4	1/5-1/2	1/50 - 1/7	1/16 - 1/3	1/5-1/2	1/16-1/5	1/5-3/8	1/16-1/8	1/4
Torque (oz-in.)	24-35	70-148	222	185-445	.35 - 3.2	10-20	38-119	48-148	112-296	8-24	34-134	101-180	20-50	33-151	25-50	100
Rated Speed (rpm)	1700	1700, 1800	1700	1700, 1800	1200, 1550, 1800, 3600	1700, 1800, 3400	1700, 1800, 3400	1700, 3450	1700, 1800	2500, 11,500	2500	2500	2500, 10,000	2500, 10,000	2500	2500

Gearmotors

Type 60P (Planetary) [Inline Gearmotors](#) | up to 226 lb-in.



	Inverter Duty AC	Permanent Magnet DC	Brushless DC
Motor Type	30R* (230V)	24A (12, 24, 90/130V)	22B (24, 130V)
HP	1/17	1/23-1/11	1/8
Torque (lb-in.)	6-172	4.6-226	10-226
Speed (rpm)	10-425	11-658	11-658

*OEM only

Type A/T (K-2) [Parallel Shaft Gearmotors](#) | up to 120 oz-in.



Motor Type	Fixed-Speed AC		
	PSC, Normal Slip, Non-Synchronous	PSC, High Slip, Non-Synchronous	PSC, Synchronous
HP	1/700-1/300	1/1000-1/450	1/2000-1/900
Torque (oz-in.)	12-120	8.9-120	8.9-120
Speed (rpm)	0.9-260	0.9-200	1-100

Type D [Parallel Shaft Gearmotors](#) | up to 40 lb-in.



Motor Type	Inverter Duty AC	Fixed-Speed AC	PMDC	BLDC	INTEGRA BLDC	
	30R	30R	24A	22B	22B/SR	22B/FV
HP	1/25-1/17	1/50-1/30	1/29-1/17	1/16	1/16	1/16
Torque (lb-in.)	19-40	5-40	3.3-40	5.8-40	5.8-40	5.8-40
Speed (rpm)	9-142	3.8-285	5.6-417	14-417	0.7-417	0.3-417

Type Z [Parallel Shaft Gearmotors](#) | up to 120 lb-in.

Now available with SCR Rated 90V or 180VDC windings.



Motor Type	Inverter Duty AC	Fixed-Speed AC	PMDC		BLDC	INTEGRA BLDC	
	34R	34R	24A	33A	22B	22B/SR	22B/FV
HP	1/6	1/15	1/17	1/12	1/16-1/11	1/16-1/11	1/16-1/11
Torque (lb-in.)	21-120	12-100	7-100	10-95	10-100	10-100	10-100
Speed (rpm)	9-283	9.6-283	14-417	42-417	14-417	0.7-417	0.7-417

Type WX [Parallel Shaft Gearmotors](#) | up to 210 lb-in.

Now available with SCR Rated 90V or 180VDC windings.



Motor Type	Fixed-Speed AC	Permanent Magnet DC				Brushless DC
	34R (115V)	33A (12/24V)		33A (90/130V)		34B (24/130V)
HP	1/7	1/11	1/4	1/8	1/4	1/5
Torque (lb-in.)	9-210	9-205	9-205	9-205	9-205	9-205
Speed (rpm)	5-447	2.9-237	8-658	5-447	8-658	8-658

Type E or F and FX Parallel Shaft Gearmotors | up to 350 lb-in.

Now available with SCR Rated 90V or 180VDC windings.



Motor Type	Inverter Duty AC		Fixed-Speed AC		Permanent Magnet DC		Brushless DC	INTEGRA BLDC
	34R-E	42R-F	42R-E	48R-F	33A-E/F	42A-E/F	34B-E/F	34B/FV-F
HP	1/6	3/8	1/12-1/4	1/3-1/2	1/16-1/3	1/8-1/3	1/5-3/8	1/4
Torque (lb-in.)	25-341	58-250	25-341	56-250	19-341	25-341	25-350	28-341
Speed (rpm)	5.7-340	57-340	5.7-340	47-340	5.8-500	8.3-500	8.3-500	14-500

Type F gearmotors feature hardened gears for increased output torque in lower ratios.

Type HG Parallel Shaft Gearmotors | up to 1000 lb-in.



Motor Type	Inverter Duty AC	Fixed-Speed AC	Permanent Magnet DC		
	42R	42R	33A (24V)	33A (90/130V)	
HP	3/8	1/5	1/3	1/6	1/3
Torque (lb-in.)	289-1000	150-599	170-680	120-481	170-680
Speed (rpm)	16-63	16-63	23-93	16-64	23-93

Type CG Parallel Shaft Gearmotors | up to 1000 lb-in.



Motor Type	Inverter Duty AC	Permanent Magnet DC	
	48R	42A (24V)	42A (130V)
HP	3/4	7/16	7/16
Torque (lb-in.)	360-1000	220-660	190-580
Speed (rpm)	28-85	38-115	42-125

Type 3F and Type 3N Right Angle Gearmotors* | up to 37 lb-in.



Motor Type	Inverter Duty AC	Fixed-Speed AC	PMDC	Brushless DC	INTEGRA BLDC	INTEGRA BLDC
	30R-3N	34R-3F	24A-3N	22B-3N	22B/SR-3N	22B/FV-3N
HP	1/17	1/15	1/17	1/8	1/8	1/8
Torque (lb-in.)	8-37	16-37	5.2-22	11-37	11-37	11-37
Speed (rpm)	28-340	28-170	42-500	42-500	3-500	1.3-500

Type 5N and Type 5F Right Angle Gearmotors* | up to 121 lb-in.

Now available with SCR Rated 90V or 180VDC windings.



Motor Type	Inverter Duty AC	Fixed-Speed AC			Permanent Magnet DC				BLDC	INTEGRA BLDC			
	42R-5N	34R-5F (50/60Hz)		42R-5N	33A-5F (24V)	33A-5F (90/130V)	42A-5N (12/24V)	42A-5N (90/130V)	34B-5N	34B/FV-5N			
HP	3/8	1/9	1/9	1/6-1/4	1/8	1/8	1/4	3/16	7/16	3/16	1/4	1/5-3/8	1/4
Torque (lb-in.)	54-121	19-121	16-102	23-113	11-55	17-84	22-109	43-109	43-109	24-109	24-109	18.6-109	24-79
Speed (rpm)	23-340	19-280	23-340	38-340	62-500	43-345	62-500	25-200	62-500	45-360	62-500	62-500	63-500

Type 3RD Right Angle Gearmotors | up to 148 lb-in.



Motor Type	Inverter Duty AC	Fixed-Speed AC	Permanent Magnet DC	Brushless DC
	30R	30R	24A	22B
HP	1/25-1/17	1/30-1/27	1/29-1/17	1/16-1/8
Torque (lb-in.)	95-148	88-148	92-147	95-147
Speed (rpm)	0.5-8.5	0.4-7.8	0.7-12.5	0.7-12.5

Type 5H Right Angle Gearmotors* | up to 296 lb-in.



Motor Type	Inverter Duty AC	Permanent Magnet DC		
	48R	33A (90/130V)		42A
HP	3/4	1/6		1/3
Torque (lb-in.)	178-296	37-137		52-192
Speed (rpm)	35-170	36-173		52-250

Type GB Right Angle Gearmotors* | up to 380 lb-in.



Motor Type	Inverter Duty AC	Fixed-Speed AC	Permanent Magnet DC		
	42R	42R	33A (90/130V)		42A
HP	3/8	1/6-1/4	1/8	1/4	1/4
Torque (lb-in.)	230-380	209-380	151-380	200-380	213-380
Speed (rpm)	6-28	5.9-28	6.2-29	8.9-42	8.9-42

*Most right angle gearmotors are available as hollow shaft models.

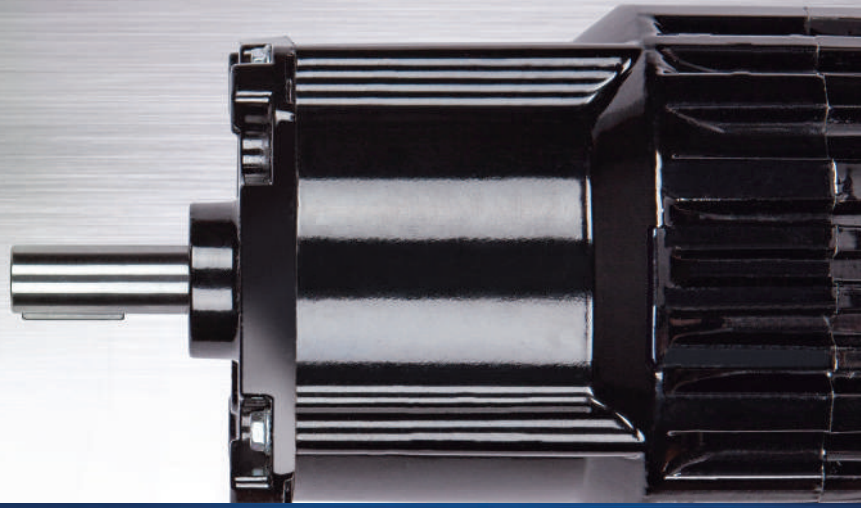

Standard products for demanding applications



Hollow Shaft Gearmotors and Accessories

Hollow shaft gearmotors connect directly to the driven load, reducing the overall space required by the gearmotor. Get the flexibility of Bodine's hollow shaft gearmotors without expensive couplings and mounting hardware.

- Rated torques: 6.8 to 380 lb-in
- Gear ratios: 5:1 to 280:1
- Single- or double-output stainless steel shaft kits
- Face-mounting flanges
- 230VAC and 230/460VAC 3-phase models available

Speed Controls for Fractional Horsepower Gearmotors

Bodine filtered and unfiltered speed controls provide optimized performance for a wide range of gearmotors and motors. Match a Bodine gearmotor and control and get an extended two-year system warranty. Chassis and enclosed models are available.

- PMDC, brushless DC, and AC motor speed controls
- Various input and output voltages (AC or DC)



bodine-electric.com

201 Northfield Road
Northfield, IL 60093
U.S.A.
Tel: 773.478.3515
Fax: 773.478.3232
info@bodine-electric.com

Presented by:

